



Auer Metallprofile

GmbH

ENDKUNDENPREISE | final customer prices

Alle Preise in diesem Katalog: Netto zzgl. Mwst. | all prices in this catalog: net plus VAT



35 JAHRE
innovativ & flexibel

35 years innovative and flexible

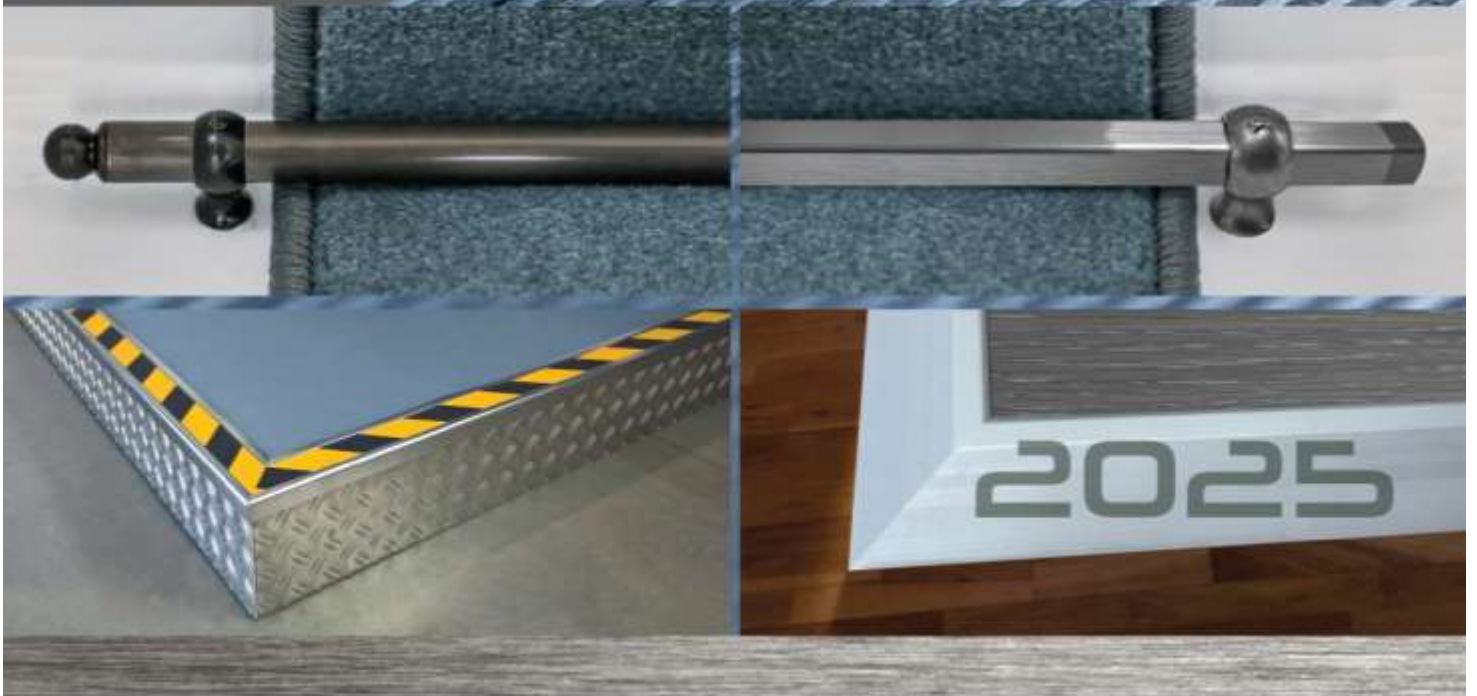



Dirk Rohde
Geschäftsführer
general manager



Manja Ulbricht
Geschäftsführerin
general manager

Sie erreichen uns telefonisch unter:
You can reach us by phone at:

+ 49 (0) 3771 / 2868-0



Jan Rohde DW - 21
Produktionsleiter / Vertrieb
production manager / distribution



Jan Ulbricht DW - 29
Vertrieb / Laserbeauftragter
distribution / laser representative



Uwe Albrecht DW - 27
Vertrieb / Reklamations-
beauftragter
distribution / complaint officer



Frank Wollrab DW - 12
Vertrieb
distribution



Nicole Scheppan DW - 15
Auftragsannahme
order acceptance



Angela Rohde DW - 31
Auftragsannahme
order acceptance



Katrin Rohde DW - 16
Buchhaltung
accounting



Kathi Wollrab DW - 28
Rechnungslegung
invoice department

Für Angebote / Ausschreibungen:
for inquiries:

Angebot@Auer-Metallprofile.de



Silke Nostitz DW - 17
Vertrieb
distribution



Carmen Sachse DW - 18
Vertrieb / Marketing
distribution / marketing

Für Ihre Bestellungen:
for your order:

Order@Auer-Metallprofile.de

Auer.Metallprofile



Für alles andere:
for everything else:

Info@Auer-Metallprofile.de

Die Auer Metallprofile-App

Ihre Profilauswahl für unterwegs –
im Apple- und Google-Store erhältlich!

Auer Metallprofile App - your profile
selection to go - available in Apple and
Google Store!

Unsere AMP - Außendienstmitarbeiter

Our AMP field service employees

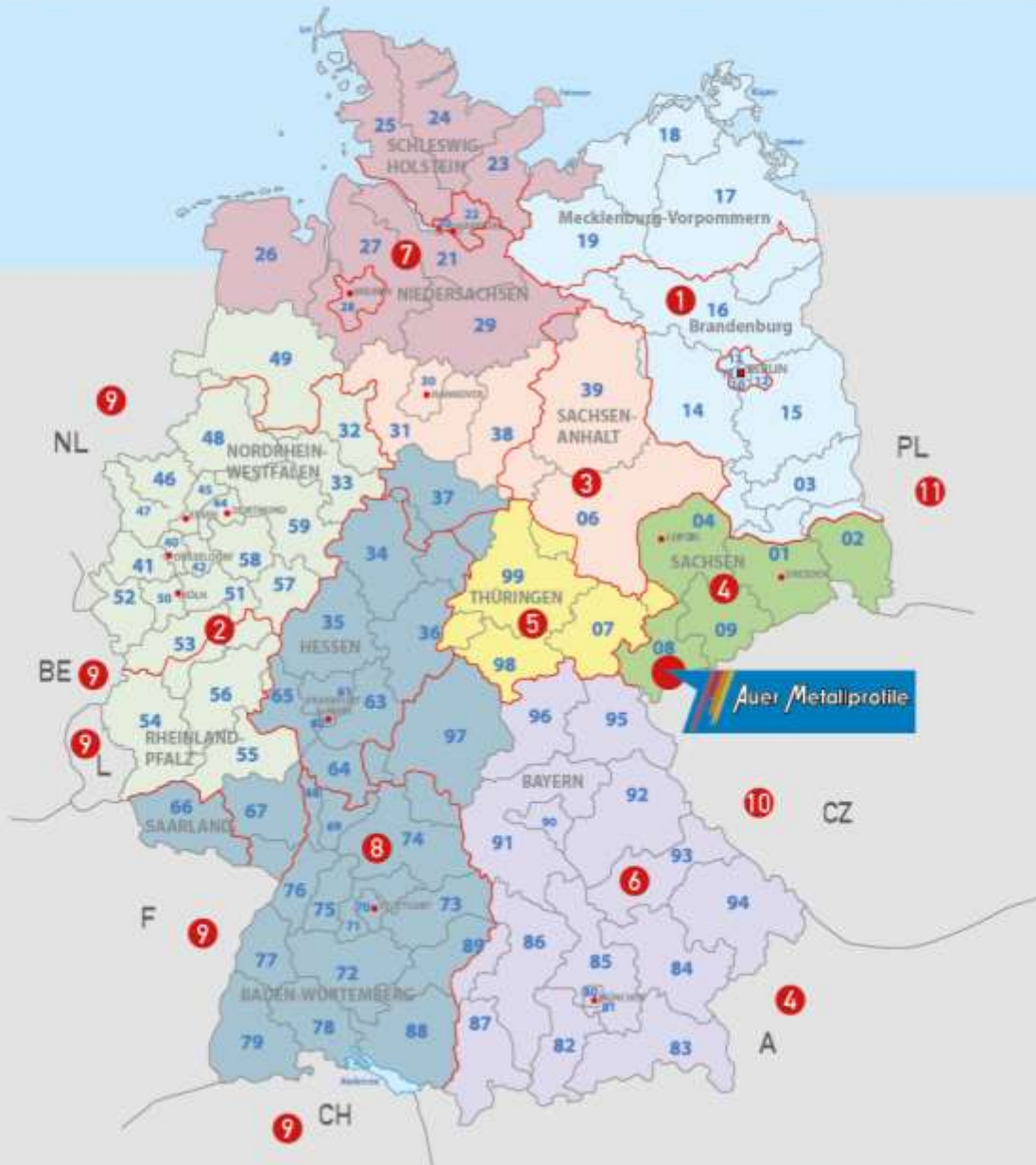

Abweichungen möglich - bei Rückfragen +49 (0)3771 / 28 18-0 | deviations possible - for any questions +49 (0)3771 / 28 18-0

- | | | | |
|--|---|--|---|
| <p>1 Marco Kalbhen
Handelsvertretung
D-14476 Fahrland
Mobil: 0175 / 20 47 971
Email: info@kalma-handel.de
Fax: 033208 / 20 89 66</p> | <p>4 Matthias Bäßler
Handelsvertretung
D-04643 Geithain
Mobil: 0171 / 82 39 292
Email: info@baessler-werkzeug.de
Fax: 034341 / 40 804</p> | <p>7 Andrea Facklam
Handelsvertretung
D-22927 Großhansdorf
Mobil: 0160 / 70 13 414
Email: A.Facklam@t-online.de
Fax: 04102 / 69 14 89</p> | <p>9 Michel Kuentz
E.I.R.L.
F - 68740 Rumersheim-Le-Haut
Mobil: 0033 633 / 10 12 56
Email: michelkuentz@orange.fr</p> |
| <p>2 André Schlepphorst
ABS-Leisten-Vertriebsges.
Mobil: 0151 / 29 50 17 82
Email: Kontakt@ABS-Leisten.de
Schlepphorst@ABS-Leisten.de</p> | <p>5 Marcel Bäßler
Handelsvertretung
D-04654 Frohburg / OT Flößberg
Mobil: 0163 / 47 74 765
Email: info@handelsagentur-baessler.de</p> | <p>8 Silke & Michael Davin
Handelsvertretung
D-63637 Jossgrund-Letigenbrunn
Fax: 06059 / 90 75 13
Silke Davin
Mobil: 0173 / 35 96 854
Email: silke.davin186@yahoo.de
Michael Davin
Mobil: 0172 / 61 93 307
Email: michael.davin@t-online.de</p> | <p>10 Veronika Burianová
RESKO Tachov s.r.o.
CZ - 34701 Tachov
Tel.: 00420 603 490 597
Email: info@resko-tachov.cz</p> |
| <p>3 Martin Paetzel
Handelsvertretung
D-39387 Oschersleben
Mobil: 0177 / 28 78 533
Email: mpae2002@freenet.de</p> | <p>6 Tanja Wehnl
Handelsagentur
D-91338 Igensdorf
Mobil: 0170 / 21 76 854
Email: tanja.wehnl@handelsagentur-wehnl.de
Fax: 09192 / 99 32 53</p> | <p>11 Grzegorz Matys
Centrum Profili
PL - 05-092 Lomianki k / W-wy
Tel.: 0048 502 / 02 90 49
Email: sklep@auer-metalprofile.pl</p> | |

**NEUHEITEN
2025**

News 2025

NEU!



Mini-T-Profil
mini T profile

583



- Größe / size: 14 x 2.2 mm
- Länge / length: 2.7 m
- Material / material:
Aluminium / aluminium
- Standard-Eloxalfarben /
standard anodized colours:
 - silber / silver
 - edelstahlfarbig /
stainless steel coloured
 - schwarz / black



584

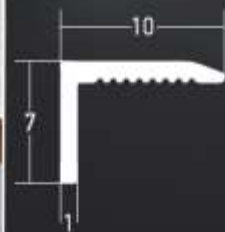

Mini-Winkel
mini angle

- Größe / size: 7 x 10 mm
- Länge / length: 2.7 m
- Material / material:
Aluminium / aluminium
- Standard-Eloxalfarben /
standard anodized colours:
 - silber / silver
 - edelstahlfarbig /
stainless steel coloured
 - schwarz / black

NEUHEITEN 2025

News 2025

NEU!



Mini - Innenecke mini inside corner



582

- filigranes
Highlight für
Ihren Belag /
filigree highlight
for your flooring

- einfache Montage /
simple installation

- Größe / size: 10 x 10 mm
- für Belagstärken ab 1,3 mm /
for covering thicknesses from 1.3 mm
- Länge / length: 2,7 m
- Material / material:
Aluminium / aluminium
- Standard-Eloxalfarben /
standard anodized colours:
 - silber / silver
 - edelstahlfarbig /
stainless steel coloured
 - schwarz / black

Mini - Außenecke mini outside corner



581

- Größe / size: 10 x 10 mm
- für Belagstärken bis 3,5 mm /
for covering thicknesses up to 3.5 mm
- Länge / length: 2,7 m
- Material / material:
Aluminium / aluminium
- Standard-Eloxalfarben /
standard anodized colours:
 - silber / silver
 - edelstahlfarbig /
stainless steel coloured
 - schwarz / black

**NEUHEITEN
2025**
News 2025

NEU!



Wand-Innenecke wall inside corner



- Größe / size: 3.5 x 3.5 mm ⁵⁷⁷
5 x 5 mm ⁵⁷⁸

- Länge / length: 2.7 m
- Material / material:
Aluminium / aluminium
- Standard-Eloxalfarben /
standard anodized colours:
 - silber / silver
 - edelstahlfarbig /
stainless steel coloured
 - schwarz / black

- für moderne Hart-
beläge an Wänden /
for modern hard
coverings on walls

- Alternative zu
herkömmlichen
Silikonfugen /
alternative to
conventional silicone
joints

- vielfältige
Gestaltungs-
möglichkeiten /
diverse design options

Wand-Außenecke wall outside corner

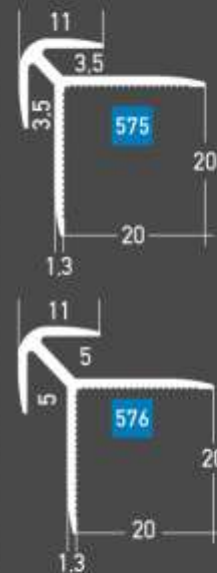

- Größe / size: 3.5 x 3.5 mm ⁵⁷⁵
5 x 5 mm ⁵⁷⁶

- Länge / length: 2.7 m
- Material / material:
Aluminium / aluminium
- Standard-Eloxalfarben /
standard anodized colours:
 - silber / silver
 - edelstahlfarbig /
stainless steel coloured
 - schwarz / black

NEUHEITEN 2025

News 2025



579



580

- Größe / size: 3,5 x 3,5 mm ⁵⁷⁹
5 x 5 mm ⁵⁸⁰

- Länge / length: 2,7 m
- Material / material: Aluminium / aluminium
- Standard-Eloxalfarben / standard anodized colours:
 - silber / silver
 - edelstahlfarbig / stainless steel coloured
 - schwarz / black

Doppelseinschub
double insert profile

Übergangprofil
connecting profile



579

- Länge / length: 2,7 m
- Material / material: Aluminium / aluminium
- Standard-Eloxalfarbe / standard anodized colour:
 - silber / silver
- Befestigung / fastening:
 - mittig gebohrt / centrally drilled
 - seitlich gebohrt / laterally drilled
 - selbstklebend / self-adhesive



514

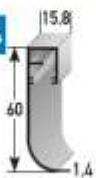

515

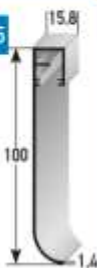

NEU: Farbe nach RAL 9016 Verkehrsweiß bei LED-Sockelleisten 60 mm und 100 mm für indirekte LED-Beleuchtung



NEW, colour powder RAL 9016 skirting 60 mm and 100 mm, for indirect LED lighting

310

NEU: Befestigungsart: ungebohrt bei DESIGN-Einklebe-Sockelleiste 60 x 10 x 3,2 mm

NEW, fastening type: undrilled for DESIGN skirting 60 x 10 x 3,2 mm



586



NEU: Quattro-Läuferstange 10 x 10 x 1,0 mm. Edelstahl matt, inkl. quadratischer Abschlussknöpfe

NEW, quattro stair rod 10 x 10 x 1,0 mm, stainless steel mat, with square endings

Kugelösen für Quattro-Läuferstange, mit o. ohne Feststellschraube, gedreht mit 8-eckiger Einsteckmöglichkeit für gerade und diagonale Befestigung

NEW, ball eyelets for Quattro stair rod, with and without locking screw, turned, with octagonal insertion option for straight and diagonal fastening

587



Seite/
page

Produktkategorien/ product categories

Form/ shape

1-27

1. Winkelprofile und Treppenkanten aus Aluminium und Messing

1. angle edges and stair nosings out of aluminium + brass

Winkelprofile / Treppenkanten / Vorstoßprofile / Fassonprofile /
 wendbare Treppenseitenprofile / ALU-Treppeninnenecken /
 Eckprofile / Kombi-Treppenkanten mit Einlagen
 angle edges / stair nosings / edge profiles / fasson stair nosings /
 turnable stair side profiles / aluminium stair inside corners / corner profiles
 combination stair nosings with inserts



28-37

2. Treppenkanten aus Edelstahl

2. stair nosings out of stainless steel

Edelstahl-Treppenkanten: *INOX PROTECT* / *profilierte Riffelung* /
gefräste Riffelung / *Prägelochung* / *Prägelochung + Anker* /
gezogen V4A / *Noppenprägung* / *Fliesen-Treppenkante* /
 Edst.-Einschubprofile mit Nase / Edst.-Treppeninnenecken
 stainless steel stair nosing: INOX PROTECT / fluted ruffle / antislip fluting /
 embossed punching / embossed punching + anchor / drawn V4A / nub embossing /
 tile stair nosing / stainless steel nosed insert profile / stainless steel stair inside corner

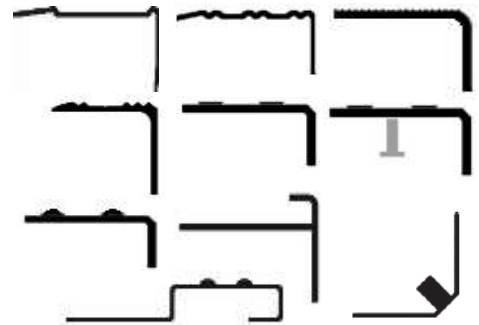

38-49

3. Wand-, Kantenschutz- & Spezialprofile aus Edelstahl, Aluminium und Messing

3. wall + corner protection and special profiles out of stainless steel + aluminium + brass

Wandprofile / MINI-Profil / Eckschutzwinkel /
 Edst.-Deko-Winkel / Edst.-Einschubprofile /
 Edst.-Ausgleichsprofile / Miniwinkel / Edelstahl-Spezialprofile
 wall profiles / mini profiles / corner protection angles / stainless steel deco-angles /
 stainless steel insert profiles / stainless steel leveling profiles /
 stainless steel special profiles

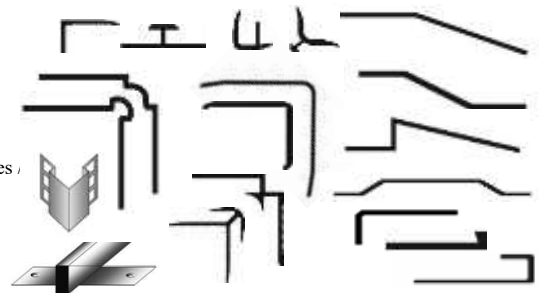

50-72

4. Übergangprofile aus Aluminium, Edelstahl und Messing

4. connecting profiles out of aluminium + stainless steel + brass

Übergangprofile Aluminium / Messing / Edelstahl /
 Edelstahl-Übergangprofile: *profilierte Riffelung* / *gezogen V4A* /
gekantet / *Flachschwelle* / *Verbundschwelle* / *INOX PROTECT* /
 Aluminium-Flachschwelle / Abschlussprofile /
 Anpassungsprofile / Sockelprofile
 connecting profiles aluminium / brass / stainless steel /
 stainless steel cover profiles: fluted ruffle / drawn V4A / edged / flat threshold /
 composite threshold / INOX PROTECT /
 aluminium flat threshold / adaptation profiles / levelling profiles / plinth profiles



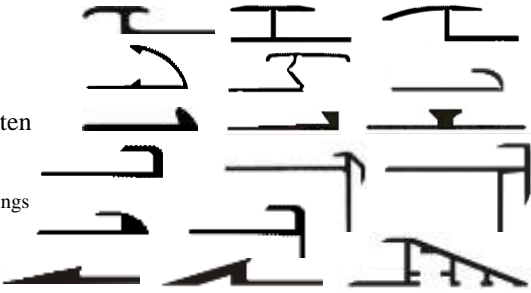

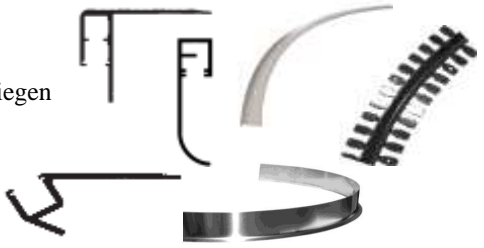
73-91	5. Einschub- und Anstoßprofile aus Aluminium
	5. insert profiles out of aluminium
<p>ein- & doppelseitige Einschubprofile mit & ohne Nase / Doppel- / Einfach- / Miniklemmprofile / Anstoßprofile / Rampenprofile / Einfassschienen / Doppelseitig-Treppenkanten</p> <p>one and double sided insert profiles with and without nose / double-/ single-/ mini clamping profiles / ramp profiles // double insert stair nosings</p>	

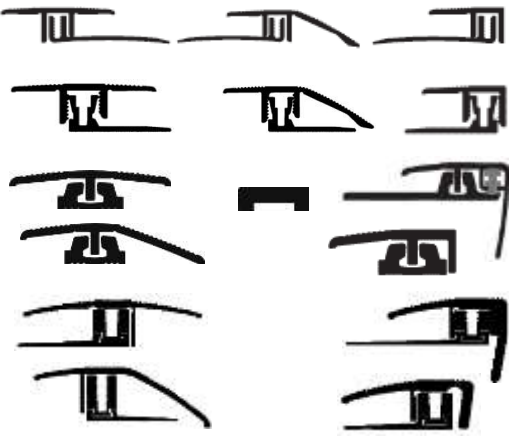
92-96	6. LED und Service
	6. LED + service
<p>LED-Treppenkanten direkt + indirekt / LED-Sockelleisten indirekt/ Serviceleistungen / ungebohrt / ausklinken & biegen / Säulenringe biegen</p> <p>LED stair nosing direct + indirect / LED skirting indirect service / undrilled / flanges notched + bent / pillar ring bent</p>	

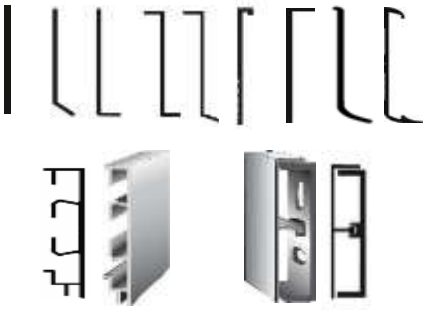
97-112	7. Systemprofile aus Aluminium und Edelstahl für 4 - 24 mm Beläge
	7. system profiles out of aluminium + stainless steel for 4 - 24 mm floorings
<p>MINI-APL-System 5-9 mm / APL-System 7-15 mm / MINI-APL-Klick-System 4-7 mm / APL-Klick-System 7-10 / 11-15 / 15-24 mm / SKD-System 4-7 mm / SLP-System 7-17 / 12-22 mm</p> <p>MINI-APL-system 5-9 mm / APL-system 7-15 mm / MINI-APL-click-system 4-7 mm / APL-click-system 7-10 / 11-15 / 15-24 mm / SKD-system 4-7 mm / SLP-system 7-17 / 12-22 mm</p>	

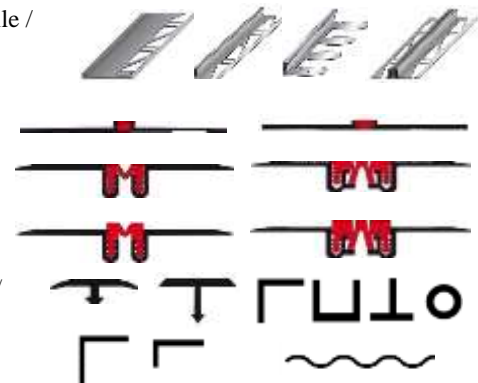
113-129	8. Sockelleisten aus Edelstahl und Aluminium
	8. skirtings out of stainless steel + aluminium
<p>Edelstahl-Sockelleisten: TYP I / L / J / r -Form + Ecken / Aluminium-Sockelleisten: Sockelleisten TYP I / L / J / r -Form + Zubehör / Sockelleisten Contego + Zubehör / Sockelblech / Design-Einklebe-Sockel. / Klick-Sockelleisten + Zubehör</p> <p>stainless steel skirtings type I / L / J / r-form + corners / aluminium: skirtings type I / L / J / r-form + accessories / skirting metal sheet / skirtings Contego + accessories / design skirting / click-skirting + accessories</p>	

130-142	9. Fliesentrenn-, Dehnungsfugen-, Bau- & T-Profile aus Aluminium, Edelstahl, Messing & PVC
	9. ceramic tile separation profiles + expansion gap profiles out of aluminium + stainless steel + brass + PVC
<p>Fliesentrennprofile / Flexible Fliesentrennpr. / Dehnungsfugenprofile / SPEZIAL-Dehnungsfugenprofile, Fugenbreite bis 20 mm / SUPER-Dehnungsfugenprofile, Fugenbreite 20/ 35 mm / Wellenverbinder / Bauprofile: <i>Winkel / U-Profile / Rohre / Flachprofile / Vierkantrohre / T-Profile + Befestigung</i></p> <p>ceramic tile separation profiles / flexible ceramic tile separation profiles / expansion gap profiles / SPECIAL expansion gap profiles over 20 mm joint width / SUPER expansion gap profile, joint width 20 / 35 mm / wave connectors / pipes / flat profiles / rectangular pipes / T profiles + fastening</p>	

143-152	10. Läuferstangen aus Messing und Edelstahl
	10. stair rods out of brass + stainless steel
<p>Läuferstange Ø 10 / 13 / 16 / 25 mm + Zubehör / Quattro-Läuferstange 10 x 10 mm + Zubehör / Dreikantläuferstange 16x16 mm + Zubehör / Teppichschrauben & -nägeln</p> <p>stair rod Ø 10 / 13 / 16 / 25 mm + accessories / quattro stair rod 10 x 10 mm + accessories / triangular stair rod 16x16 mm + accessories / carpet screws + carpet nails</p>	

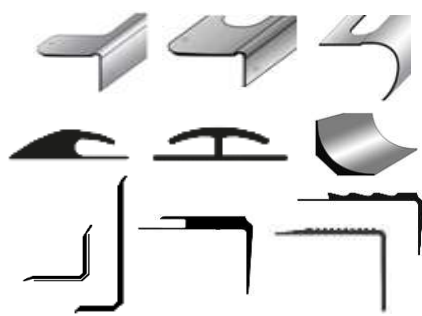
153-157	11. Reparaturwinkel f. Treppen und PVC-Profile
	11. repair angles for stairs + PVC profiles
<p>Reparaturwinkel Edelstahl + verzinkter Stahl / Rund-Reparaturwinkel / PVC-Profile: <i>PVC-Einfassleisten ein- u. doppelseitig / Stufenmattenwinkel / Knickwinkel / Weichsockelleisten / Hohlkehprofil / PVC-Treppenkanten</i></p> <p>repair angles stainless steel + galvanized steel / round repair angles / PVC profiles: insert profiles single and double-sided / PVC-angles for stair mats / edge profiles / soft skirtings / hollow profile / stair nosings</p>	

158-165	12. Zubehör
	12. accessories
<p>Verlegebänder / Montagekleber / Schrauben / Dübel / Ringnägeln / Leistenstifte / Türstopper / Wegmarkierungsronden / Edelst.-Heizrohrrosetten / Lüftungsbleche</p> <p>tapes / builders adhesive / screws / dowels / rifled nails / pins / door stopper / trail marker ronden / stainless steel heating pipe rosettes</p>	

166-170	13. Hinweise und AGB
	13. hints + terms and conditions
<p>Verlegehinweise / AGB - Liefer- & Zahlungsbedingungen</p> <p>installation tips / terms and conditions - delivery and payment</p>	

Register/ register

1. Winkelprofile und Treppenkanten aus Aluminium und Messing 1. angle edges and stair nosings out of aluminium + brass	1
2. Treppenkanten aus Edelstahl 2. stair nosings out of stainless steel	2
3. Wand-, Kantenschutz- und Spezialprofile aus Edelstahl, Aluminium & Messing 3. wall, corner protection and special profiles out of stainless steel + aluminium + brass	3
4. Übergangprofile aus Aluminium, Edelstahl und Messing 4. connecting profiles out of aluminium + stainless steel + brass	4
5. Einschub- und Anstoßprofile aus Aluminium 5. insert profiles out of aluminium	5
6. LED + Service 6. LED + service	6
7. Systemprofile aus Aluminium und Edelstahl für 4 - 24 mm Beläge 7. system profiles out of aluminium + stainless steel for 4 - 24 mm floorings	7
8. Sockelleisten aus Edelstahl und Aluminium 8. skirtings out of stainless steel + aluminium	8
9. Fliesentrenn-, Dehnungsfugen-, Bau- & T-Profile aus Aluminium, Edelstahl, Messing & PVC 9. ceramic tile separation profiles + expansion gap profiles out of aluminium + stainless steel + brass + PVC	9
10. Läuferstangen aus Messing und Edelstahl 10. stair rods out of brass + stainless steel	10
11. Reparaturwinkel f. Treppen und PVC-Profile 11. repair angles for stairs + PVC profiles	11
12. Zubehör 12. accessories	12
13. Hinweise und AGB 13. hints + terms and conditions	13

1. WINKELPROFILE + TREPPENKANTEN AUS ALUMINIUM UND MESSING

1. ANGLE EDGES + STAIR NOSINGS
OUT OF ALUMINIUM AND BRASS

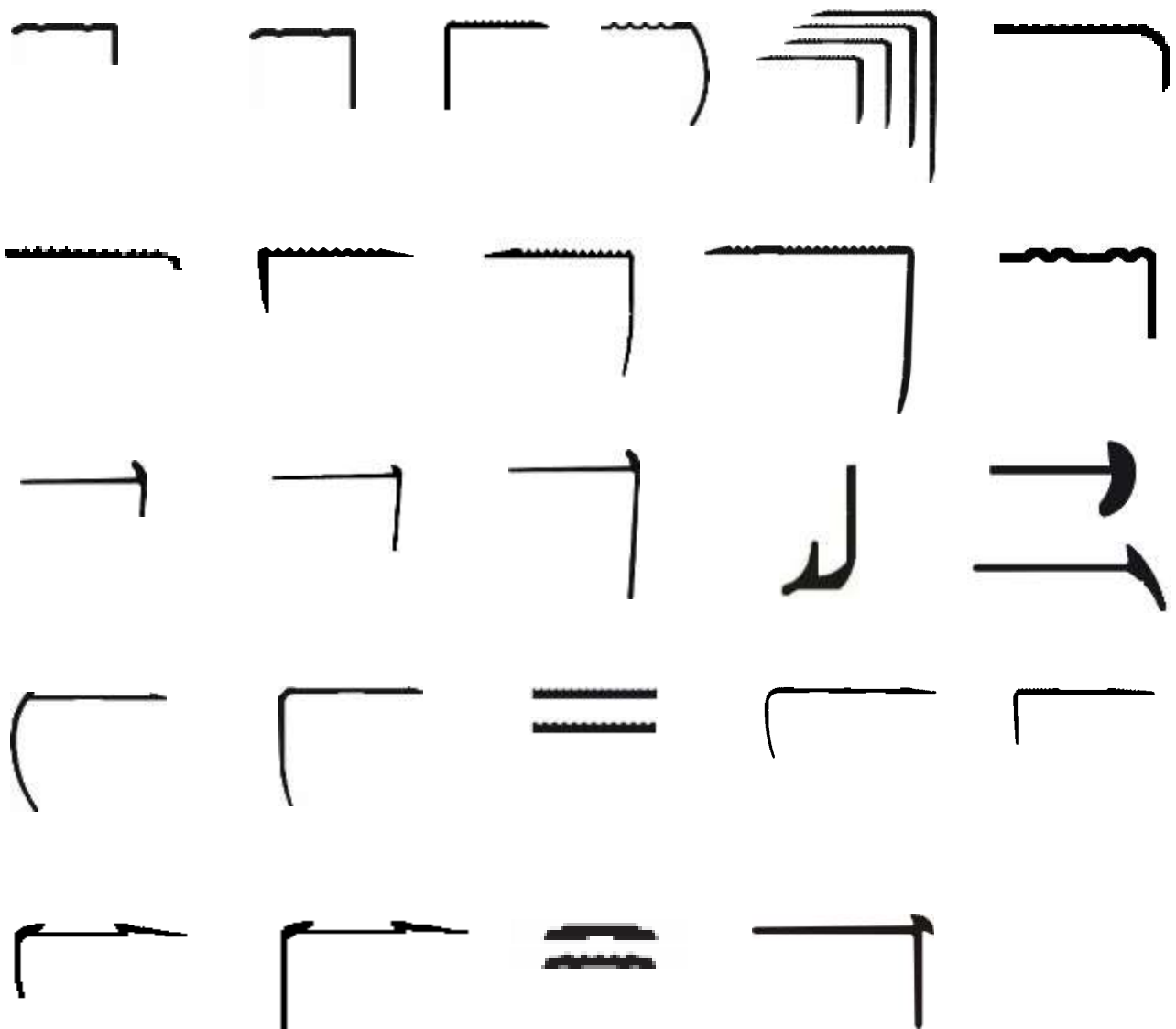

1. WINKELPROFILE + TREPPENKANTEN AUS ALUMINIUM + MESSING / 1. ANGLE EDGES + STAIR NOSINGS ALU + BRASS

Andere Eloxalfarben siehe Abschnitt 6,
 Lieferzeit 14 Tage/ other anodized colours
 see section 6, delivery time 14 days

Profi-Pack à 10 Stück im Bund			
professional packing à 10 pcs.			
Farbe/colour	L / l (m)	Art./ref.	€/Stk./pcs.

SB-Pack incl. Schr./ Dübel; VE 20 Stk.	
self-service-pack with screws/ dowels; à 20 pcs.	
Art./ref.	€/Stk./pcs.

8 9 Winkelprofil 10 x 24,5 mm, Aluminium eloxiert, gebohrt

angle edge 10 x 24,5 mm,
 aluminium anodized, drilled



silberfarbig silver	0,8	04480-2	4,16
	0,9	04490-1	4,64
	1,0	04500-7	5,16
	1,2	04510-6	6,20
	2,0	04520-5	10,36
goldfarbig gold	2,7	04530-4	13,98
	0,8	04580-9	5,18
	0,9	04590-8	5,86
	1,0	04600-4	6,50
	1,2	04610-3	7,82
bronzefarbig hell bronze light	2,0	04620-2	13,00
	2,7	04630-1	17,58
	0,8	04680-6	5,50
	0,9	04690-5	6,20
	1,0	04700-1	6,90
bronzefarbig dunkel bronze dark	1,2	04710-0	8,26
	2,0	04720-9	13,80
	2,7	04730-8	18,62
	0,8	04780-3	5,50
	0,9	04790-2	6,20
gold hell gold light	1,0	04800-8	6,90
	1,2	04810-7	8,26
	2,0	04820-6	13,80
	2,7	04830-5	18,62
	0,8	70580-2	5,18
edelstahlfarbig Feinschliff fine-honed stainless steel coloured	0,9	70582-6	5,86
	1,0	70584-0	6,50
	1,2	70586-4	7,82
	2,0	70588-8	13,00
	2,7	70590-1	17,58
schwarz black	0,8	70592-5	5,50
	0,9	70594-9	6,20
	1,0	70596-3	6,90
	1,2	70598-7	8,26
	2,0	70600-7	13,80
	2,7	70602-1	18,62
	1,0	72024-9	6,90
	2,7	72026-3	18,62

04491-8	5,58
04501-4	6,10
04521-2	12,20
04531-1	16,76
04591-5	6,86
04601-1	7,46
04621-9	15,10
04631-8	20,60
04691-2	7,34
04701-8	8,04
04721-6	16,12
04731-5	22,12
04791-9	7,20
04801-5	7,90
04821-3	15,82
04831-2	21,64
70604-5	6,86
70606-9	7,46
70608-3	15,10
70610-6	20,60
70612-0	7,20
70614-4	7,90
70616-8	15,82
70618-2	21,64
72028-7	7,90
72030-0	21,64

Holzdekorfolie/wood decor	Buche beech	1,0	38700-8	11,94
		2,7	38710-7	32,32
	Eiche oak	1,0	38720-6	11,94
		2,7	38730-5	32,32
	Ahorn maple	1,0	38740-4	11,94
		2,7	38750-3	32,32
	Kirschbaum cherry wood	1,0	38760-2	11,94
		2,7	38765-7	32,32
	Eiche rustikal rustic oak	1,0	38770-1	11,94
		2,7	38775-6	32,32

38701-5	13,02
38711-4	35,20
38721-3	13,02
38731-2	35,20
38741-1	
38751-0	35,20
38761-9	13,02
38766-4	35,20
38771-8	13,02
38776-3	35,20

1. WINKELPROFILE + TREPPENKANTEN AUS ALUMINIUM + MESSING / 1. ANGLE EDGES + STAIR NOSINGS ALU + BRASS

Andere Eloxafarben siehe Abschnitt 6,
 Lieferzeit 14 Tage/ other anodized colours
 see section 6, delivery time 14 days

Profi-Pack à 10 Stück im Bund			
professional packing à 10 pcs.			
Farbe/colour	L / l (m)	Art./ref.	€/Stk./pcs.

SB-Pack incl. Schr./ Dübel; VE 20 Stk.	
self-service-pack with screws/ dowels; à 20 pcs.	
Art./ref.	€/Stk./pcs.

8 9 Winkelprofil 10 x 24,5 mm, Aluminium eloxiert, selbstklebend

angle edge 10 x 24,5 mm,
 aluminium anodized,
 self adhesive



silberfarbig silver	1,0	04503-8	6,90
	2,7	04533-5	18,62
goldfarbig gold	1,0	04603-5	8,36
	2,7	04633-2	22,58
bronzef. hell bronze light	1,0	04703-2	8,74
	2,7	04733-9	23,64
bronzef. dunkel bronze dark	1,0	04803-9	8,74
	2,7	04833-6	23,64
gold hell gold light	1,0	70622-9	8,36
	2,7	70624-3	22,58
edelstahlfarbig Feinschliff fine-honed stainless steel coloured	1,0	70626-7	8,74
	2,7	70628-1	23,64
schwarz black	1,0	72032-4	8,74
	2,7	72034-8	23,64

04502-1	7,84
04532-8	21,20
04602-8	9,42
04632-5	25,36
04702-5	9,78
04732-2	26,40
04802-2	9,78
04832-9	26,40
70630-4	9,42
70632-8	25,36
70634-2	9,78
70636-6	26,40
72036-2	9,78
72038-6	26,40

Holzdekorfolie/ wood decor	Buche beech	1,0	38640-7	14,70
		2,7	38650-6	39,62
	Eiche oak	1,0	38660-5	14,70
		2,7	38670-4	39,62
	Ahorn maple	1,0	38680-3	14,70
		2,7	38690-2	39,62
	Kirschbaum cherry wood	1,0	38780-0	14,70
		2,7	38785-5	39,62
	Eiche rustikal rustic oak	1,0	38790-9	14,70
		2,7	38795-4	39,62

38641-4	15,32
38651-3	41,42
38661-2	15,32
38671-1	41,42
38681-0	15,32
38691-9	41,42
38781-7	15,32
38786-2	41,42
38791-6	15,32
38796-1	41,42

1. WINKELPROFILE + TREPPENKANTEN AUS ALUMINIUM + MESSING / 1. ANGLE EDGES + STAIR NOSINGS ALU + BRASS

Andere Eloxalfarben siehe
 Abschnitt 6, Lieferzeit 14 Tage
 other anodized colours see section 6,
 delivery time 14 days

Profi-Pack à 10 Stück im Bund			
professional packing à 10 pcs.			
Farbe/colour	L / l (m)	Art./ref.	€/Stk./pcs.

SB-Pack incl. Schr./ Dübel; VE 20 Stk.	
self-service-pack with screws/ dowels; à 20 pcs.	
Art./ref.	€/Stk./pcs.

8 8 Winkelprofil 18 x 24,5 mm, Aluminium eloxiert, gebohrt

angle edge 18 x 24,5 mm,
 aluminium anodized, drilled



silberfarbig silver	0,8	04080-4	4,64
	0,9	04090-3	5,26
	1,0	04100-9	5,82
	1,2	04110-8	6,98
	2,0	04120-7	11,64
goldfarbig gold	2,7	04130-6	15,74
	0,8	04180-1	6,36
	0,9	04190-0	7,18
	1,0	04200-6	7,96
	1,2	04210-5	9,56
bronzefarbig hell bronze light	2,0	04220-4	15,92
	2,7	04230-3	21,46
	0,8	04280-8	6,76
	0,9	04290-7	7,60
	1,0	04300-3	8,40
bronzefarbig dunkel bronze dark	1,2	04310-2	10,10
	2,0	04320-1	16,82
	2,7	04330-0	22,76
	0,8	04380-5	6,76
	0,9	04390-4	7,60
gold hell gold light	1,0	04400-0	8,40
	1,2	04410-9	10,10
	2,0	04420-8	16,82
	2,7	04430-7	22,76
	0,8	70640-3	6,36
edelstahlfarbig Feinschliff fine-honed stainless steel coloured	0,9	70642-7	7,18
	1,0	70644-1	7,96
	1,2	70646-5	9,56
	2,0	70648-9	15,92
	2,7	70650-2	21,46
schwarz black	0,8	70652-6	6,76
	0,9	70654-0	7,60
	1,0	70656-4	8,40
	1,2	70658-8	10,10
	2,0	70660-1	16,82
Buche beech	2,7	70662-5	22,76
	1,0	72040-9	8,40
	2,7	72042-3	22,76
	1,0	38520-2	13,36
	2,7	38530-1	36,18
Eiche oak	1,0	38540-0	13,36
	2,7	38550-9	36,18
Ahorn maple	1,0	38560-8	13,36
	2,7	38570-7	36,18
Kirschbaum cherry wood	1,0	38580-6	13,36
	2,7	38585-1	36,18
Eiche rustikal rustic oak	1,0	38590-5	13,36
	2,7	38595-0	36,18

04091-0	6,18
04101-6	6,76
04121-4	13,52
04131-3	18,52
04191-7	8,18
04201-3	8,98
04221-1	17,96
04231-0	24,52
04291-4	8,72
04301-0	9,56
04321-8	19,12
04331-7	26,22
04391-1	8,56
04401-7	9,42
04421-5	18,86
04431-4	25,78
70664-9	8,18
70666-3	8,98
70668-7	17,96
70670-0	24,52
70672-4	8,56
70674-8	9,42
70676-2	18,86
70678-6	25,78
72044-7	9,42
72046-1	25,78

Holzdekorfolie/ wood decor	Buche beech	1,0	38520-2	13,36
		2,7	38530-1	36,18
	Eiche oak	1,0	38540-0	13,36
		2,7	38550-9	36,18
	Ahorn maple	1,0	38560-8	13,36
		2,7	38570-7	36,18
	Kirschbaum cherry wood	1,0	38580-6	13,36
		2,7	38585-1	36,18
	Eiche rustikal rustic oak	1,0	38590-5	13,36
		2,7	38595-0	36,18

38521-9	14,42
38531-8	38,98
38541-7	14,42
38551-6	38,98
38561-5	14,42
38571-4	38,98
38581-3	14,42
38586-8	38,98
38591-2	14,42
38596-7	38,98

1. WINKELPROFILE + TREPPENKANTEN AUS ALUMINIUM + MESSING / 1. ANGLE EDGES + STAIR NOSINGS ALU + BRASS

Andere Eloxalfarben siehe
 Abschnitt 6, Lieferzeit 14 Tage
 other anodized colours see section 6,
 delivery time 14 days

Profi-Pack à 10 Stück im Bund			
professional packing à 10 pcs.			
Farbe/colour	L / l (m)	Art./ref.	€/Stk./pcs.

SB-Pack incl. Schr./ Dübel; VE 20 Stk.	
self-service-pack with screws/ dowels; à 20 pcs.	
Art./ref.	€/Stk./pcs.

8 8 Winkelprofil 18 x 24,5 mm, Aluminium eloxiert, selbstklebend

angle edge 18 x 24,5 mm,
 aluminium anodized,
 self-adhesive



silberfarbig silver	1,0	04103-0	7,56
	2,7	04133-7	20,38
goldfarbig gold	1,0	04203-7	9,50
	2,7	04233-4	25,68
bronzef. hell bronze light	1,0	04303-4	9,98
	2,7	04333-1	26,82
bronzef. dunkel bronze dark	1,0	04403-1	9,98
	2,7	04433-8	26,82
gold hell gold light	1,0	70682-3	9,50
	2,7	70684-7	25,68
edelstahlfarbig Feinschliff fine-honed stainless steel coloured	1,0	70686-1	9,98
	2,7	70688-5	26,82
schwarz black	1,0	72048-5	9,98
	2,7	72050-8	26,82

04102-3	8,52
04132-0	22,96
04202-0	10,50
04232-7	28,38
04302-7	10,96
04332-4	29,52
04402-4	10,96
04432-1	29,52
70690-8	10,50
70692-2	28,38
70694-6	10,96
70696-0	29,52
720522	10,96
720546	29,52

Holzdekorfolie/ wood decor	Buche beech	1,0	38460-1	16,12
		2,7	38470-0	43,52
	Eiche oak	1,0	38480-9	16,12
		2,7	38490-8	43,52
	Ahorn maple	1,0	38500-4	16,12
		2,7	38510-3	43,52
	Kirschbaum cherry wood	1,0	38600-1	16,12
		2,7	38605-6	43,52
	Eiche rustikal rustic oak	1,0	38610-0	16,12
		2,7	38615-5	43,52

38461-8	16,78
38471-7	45,34
38481-6	16,78
38491-5	45,34
38501-1	16,78
38511-0	45,34
38601-8	16,78
38606-3	45,34
38611-7	16,78
38616-2	45,34

1. WINKELPROFILE + TREPPENKANTEN AUS ALUMINIUM + MESSING / 1. ANGLE EDGES + STAIR NOSINGS ALU + BRASS

Andere Eloxafarben siehe
Abschnitt 6, Lieferzeit 14 Tage
other anodized colours see section 6,
delivery time 14 days

Profi-Pack à 10 Stück im Bund			
professional packing à 10 pcs.			
Farbe/colour	L / l (m)	Art./ref.	€/Stk./pcs.

SB-Pack incl. Schr./ Dübel; VE 20 Stk.	
self-service-pack with screws/ dowels; à 20 pcs.	
Art./ref.	€/Stk./pcs.

90 Treppenkante 20 x 20 mm, Aluminium eloxiert, gebohrt

stair nosing 20 x 20 mm,
aluminium anodized, drilled

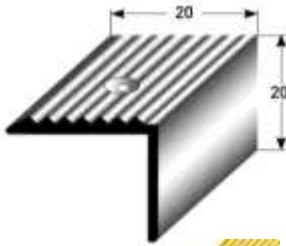

100

silberfarbig silver	1,0	39500-3	7,20	39501-0	8,20
	2,7	39510-2	19,44		
goldfarbig gold	1,0	39520-1	8,12	39521-8	9,12
	2,7	39530-0	21,92		
bronzef. hell bronze light	1,0	39540-9	8,66	39541-6	10,18
	2,7	39550-8	23,44		
bronzef. dunkel bronze dark	1,0	39560-7	8,66	39561-4	9,66
	2,7	39570-6	23,44		

28732-2	34,48
28731-5	86,36

MESSING poliert brass polished		1,0	28733-9	33,08
		2,5	28730-8	82,68

Bitte fordern Sie unsere Pflegehinweise für Messingprofile an! / Please ask for our care tips for brass profiles!

85 Treppenkante 30 x 30 mm, Aluminium eloxiert, gebohrt

stair nosing 30 x 30 mm,
aluminium anodized, drilled

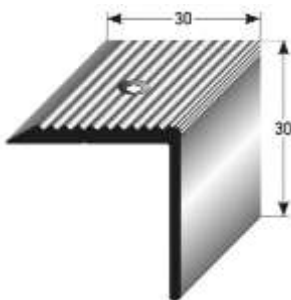

99

silberfarbig silver	0,9	31450-9	8,58	31456-1	10,50		
	1,0	31455-4	9,54			31461-5	28,32
	2,7	31460-8	25,74				
goldfarbig gold	0,9	31465-3	11,46	31471-4	13,80		
	1,0	31470-7	12,80			31476-9	37,22
	2,7	31475-2	34,46				
bronzef. hell bronze light	0,9	31480-6	13,00	31486-8	15,92		
	1,0		14,42			31491-2	43,04
	2,7	31490-5	39,00				
bronzef. dunkel bronze dark	0,9	31495-0	13,00	31501-8	15,46		
	1,0	31500-1	14,42			31506-3	41,72
	2,7	31505-6	39,00				

28753-7	56,22
28751-3	141,10

MESSING poliert brass polished		1,0	28752-0	54,98
		2,5	28750-6	137,48

Bitte fordern Sie unsere Pflegehinweise für Messingprofile an! / Please ask for our care tips for brass profiles!

Aluminium mit abriebfester Spezialmaillierung, gebohrt/ aluminium enameled, hard wearing, drilled



Edelstahl-Emaillbeschichtung
Farbton - dunkelgrau

stainless steel-enameled, colour - dark grey



Emaillbeschichtung
Farbton - silber metallic

stainless steel-enameled, colour - silver metallic



Edelst.-Emaillbeschichtung
mit 4 nachleuchtenden Rillen
Farbton - dunkelgrau

stainless steel-enameled with 4 photoluminescent grooves, colour - dark grey

Edelstahl-Emaillbeschichtung Farbton - dunkelgrau	1,0	40060-8	33,60	40061-5	35,66		
	2,0	72848-1	67,18			72850-4	71,32
	2,7 *	40070-7 *	90,70			40071-4 *	96,90
Emaillbeschichtung Farbton - silber metallic	1,0	40210-7	43,42	40212-1	45,48		
	2,0	72852-8	86,82			72854-2	90,96
	2,7 *	40211-4 *	116,72			40213-8 *	122,92
Edelst.-Emaillbeschichtung mit 4 nachleuchtenden Rillen Farbton - dunkelgrau	1,0	40065-3	60,80	40067-7	62,88		
	2,0	72856-6	121,62			72858-0	125,74
	2,7 *	40075-2 *	164,18			40077-6 *	170,40

40061-5	35,66
72850-4	71,32
40071-4 *	96,90
40212-1	45,48
72854-2	90,96
40213-8 *	122,92
40067-7	62,88
72858-0	125,74
40077-6 *	170,40

* Auslaufartikel / discontinued item

passende emaillierte Schrauben siehe Abschnitt 12/ suitable enameled screws see section 12

1. WINKELPROFILE + TREPPENKANTEN AUS ALUMINIUM + MESSING / 1. ANGLE EDGES + STAIR NOSINGS ALU + BRASS

Andere Eloxafarben siehe
 Abschnitt 6, Lieferzeit 14 Tage/
 other anodized colours see
 section 6, delivery time 14 days

Profi-Pack à 10 Stück im Bund			
professional packing à 10 pcs.			
Farbe/colour	L / l (m)	Art./ref.	€/Stk./pcs.

SB-Pack incl. Schr./ Dübel; VE 20 Stk.	
self-service-pack with screws/ dowels; à 20 pcs.	
Art./ref.	€/Stk./pcs.

372 Treppenkante 30 x 30 x 2 mm R, Aluminium eloxiert, gebohrt

stair nosing 30 x 30 x 2 mm R,
 aluminium anodized, drilled

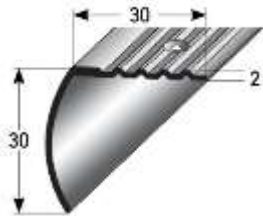

silberfarbig silver	1,0	66200-6	9,44
	2,7	66202-0	25,46
goldfarbig gold	1,0	66204-4	9,84
	2,7	66206-8	26,60
bronzef. hell bronze light	1,0	66208-2	10,86
	2,7	66210-5	29,40
bronzef. dunkel bronze dark	1,0	66212-9	11,38
	2,7	66214-3	30,76

66216-7	10,54
66218-1	28,76
66220-4	10,96
66222-8	29,90
66224-2	11,96
66226-6	32,70
66228-0	12,46
66230-3	34,06

342 Treppenkante 22 x 30 mm, Aluminium eloxiert, gebohrt

stair nosing 22 x 30 mm,
 aluminium anodized, drilled

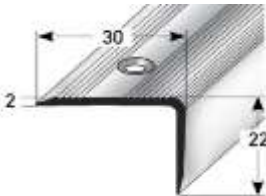

silberfarbig silver	1,0	65540-4	9,32
	2,7	65542-8	25,12
goldfarbig gold	1,0	65544-2	9,62
	2,7	65546-6	25,98
bronzef. hell bronze light	1,0	65548-0	10,84
	2,7	65550-3	29,36
bronzef. dunkel bronze dark	1,0	65552-7	10,84
	2,7	65554-1	29,36

65560-2	10,28
65562-6	28,06
65564-0	10,62
65566-4	28,98
65568-8	12,34
65570-1	33,80
65572-5	11,84
65574-9	32,32

388 Treppenkante 27 x 27 mm, Aluminium eloxiert, gebohrt

stair nosing 27 x 27 mm,
 aluminium anodized, drilled

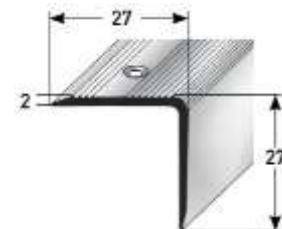

silberfarbig silver	1,0	67196-1	9,66
	2,7	67198-5	26,16
goldfarbig gold	1,0	67200-5	10,02
	2,7	67202-9	27,04
bronzef. hell bronze light	1,0	67204-3	11,24
	2,7	67206-7	30,38
bronzef. dunkel bronze dark	1,0	67208-1	11,24
	2,7	67210-4	30,38

67216-6	10,12
67218-0	29,10
67220-3	11,02
67222-7	30,00
67224-1	12,76
67226-5	34,82
67228-9	12,24
67230-2	33,34

343 Treppenkante 32 x 30 mm, Aluminium eloxiert, gebohrt

stair nosing 32 x 30 mm,
 aluminium anodized, drilled

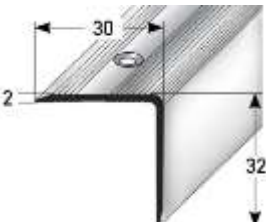

silberfarbig silver	1,0	65582-4	11,68
	2,7	65584-8	31,50
goldfarbig gold	1,0	65586-2	12,42
	2,7	65588-6	33,58
bronzef. hell bronze light	1,0	65590-9	14,02
	2,7	65592-3	37,84
bronzef. dunkel bronze dark	1,0	65594-7	14,02
	2,7	65596-1	37,84

65602-9	12,62
65604-3	34,44
65606-7	13,40
65608-1	36,54
65610-4	15,52
65612-8	42,32
65614-2	15,00
65616-6	40,84

1. WINKELPROFILE + TREPPENKANTEN AUS ALUMINIUM + MESSING / 1. ANGLE EDGES + STAIR NOSINGS ALU + BRASS

Andere Eloxalfarben siehe
 Abschnitt 6, Lieferzeit 14 Tage
 other anodized colours see
 section 6, delivery time 14 days

Profi-Pack à 10 Stück im Bund			
professional packing à 10 pcs.			
Farbe/colour	L / l (m)	Art./ref.	€/Stk./pcs.

SB-Pack incl. Schr./ Dübel; VE 20 Stk.	
self-service-pack with screws/ dowels; à 20 pcs.	
Art./ref.	€/Stk./pcs.

344 Treppenkante 42 x 30 mm, Aluminium eloxiert, gebohrt

stair nosing 42 x 30 mm,
 aluminium anodized, drilled

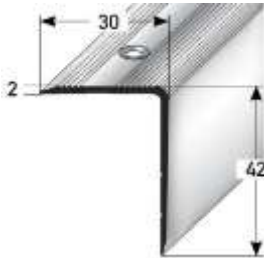

silberfarbig silver	1,0	65624-1	13,52	65644-9	14,46
	2,7	65626-5	36,46		
goldfarbig gold	1,0	65628-9	13,98	65648-7	14,96
	2,7	65630-2	37,74		
bronzef. hell bronze light	1,0	65632-6	15,10	65652-4	16,60
	2,7	65634-0	40,78		
bronzef. dunkel bronze dark	1,0	65636-4	15,10	65656-2	16,06
	2,7	65638-8	40,78		

65644-9	14,46
65646-3	39,44
65648-7	14,96
65650-0	40,72
65652-4	16,60
65654-8	45,24
65656-2	16,06
65658-6	43,74

389 Treppenkante 42 x 40 mm, Aluminium eloxiert, gebohrt

stair nosing 42 x 40 mm,
 aluminium anodized, drilled

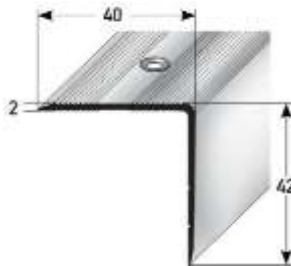

silberfarbig silver	1,0	67152-7	15,36	67172-5	16,30
	2,7	67154-1	41,42		
goldfarbig gold	1,0	67156-5	15,90	67176-3	16,86
	2,7	67158-9	42,94		
bronzef. hell bronze light	1,0	67160-2	17,78	67180-0	19,24
	2,7	67162-6	47,98		
bronzef. dunkel bronze dark	1,0	67164-0	17,78	67184-8	18,72
	2,7	67166-4	47,98		

67172-5	16,30
67174-9	44,42
67176-3	16,86
67178-7	45,92
67180-0	19,24
67182-4	52,42
67184-8	18,72
67186-2	50,94

345 Treppenkante 52 x 30 mm, Aluminium eloxiert, gebohrt

stair nosing 52 x 30 mm,
 aluminium anodized, drilled



silberfarbig silver	1,0	65666-1	15,36	65686-9	16,30
	2,7	65668-5	41,42		
goldfarbig gold	1,0	65670-8	15,90	65690-6	16,86
	2,7	65672-2	42,94		
bronzef. hell bronze light	1,0	65674-6	17,78	65694-4	19,24
	2,7	65676-0	47,98		
bronzef. dunkel bronze dark	1,0	65678-4	17,78	65698-2	18,72
	2,7	65680-7	47,98		

65686-9	16,30
65688-3	44,42
65690-6	16,86
65692-0	45,92
65694-4	19,24
65696-8	52,42
65698-2	18,72
65700-2	50,94

1. WINKELPROFILE + TREPPENKANTEN AUS ALUMINIUM + MESSING / 1. ANGLE EDGES + STAIR NOSINGS ALU + BRASS

Andere Eloxalfarben siehe
Abschnitt 6, Lieferzeit 14 Tage
other anodized colours see
section 6, delivery time 14 days

Profi-Pack à 10 Stück im Bund			
professional packing à 10 pcs.			
Farbe/colour	L / l (m)	Art./ref.	€/Stk./pcs.

SB-Pack incl. Schr./ Dübel; VE 20 Stk.	
self-service-pack with screws/ dowels; à 20 pcs.	
Art./ref.	€/Stk./pcs.

9 5 Treppenkante 15 x 40 mm, Aluminium eloxiert, gebohrt

stair nosing 15 x 40 mm,
aluminium anodized, drilled

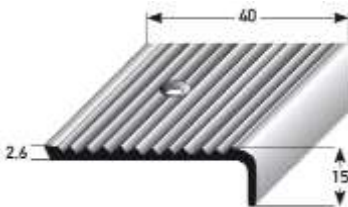

silberfarbig silver	1,0	41100-0	14,02	41105-5	15,04
	2,7	41110-9	37,94		
goldfarbig gold	1,0	41120-8	14,58	41115-4	40,62
	2,7	41130-7	39,26		
bronzef. hell bronze light	1,0	41140-6	15,84	41125-3	15,54
	2,7	41150-5	42,74		
bronzef. dunkel bronze dark	1,0	41160-4	15,84	41135-2	41,98
	2,7	41170-3	42,74		
Aluminium blank aluminium plain	1,0	41180-2	11,40	41145-1	17,32
	2,7	41190-1	30,90		

41155-0	46,74
41175-8	45,46
41195-6	33,64

8 7 Treppenkante 23 x 40 mm, Aluminium eloxiert, gebohrt

stair nosing 23 x 40 mm,
aluminium anodized, drilled

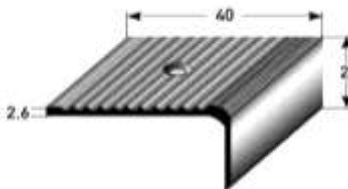

silberfarbig silver	0,9	29430-6	13,52	29436-8	16,02
	1,0	29435-1	15,02		
	2,7	29440-5	40,56		
goldfarbig gold	0,9	29445-0	14,00	29441-2	43,32
	1,0	29450-4	15,56		
	2,7	29455-9	42,04		
bronzef. hell bronze light	0,9	29460-3	15,32	29451-1	16,56
	1,0	29465-8	17,02		
	2,7	29470-2	45,96		
bronzef. dunkel bronze dark	0,9	29475-7	15,32	29456-6	44,80
	1,0	29480-1	17,02		
	2,7	29485-6	45,96		

29466-5	18,56		
		29471-9	50,10
		29481-8	18,04
29486-3	48,72		

Aluminium mit abriebfester Spezialmaillierung, gebohrt/ aluminium enameled, hard wearing, drilled



Edelst.-Emaillbeschichtung
Farbton - dunkelgrau

stainless steel-enameled, colour - dark grey

1,0	40080-6	39,08
2,0	72836-8	78,16
2,7 *	40090-5 *	105,52

40081-3	41,16
72838-2	82,28
40091-2 *	111,70



Emaillbeschichtung
Farbton - silber metallic

stainless steel-enameled, colour - silver metallic

1,0	40230-5	48,90
2,0	72840-5	97,80
2,7 *	40231-2 *	132,04

40232-9	50,96
72842-9	101,94
40233-6 *	138,24



Edelst.-Emaillbeschichtung mit
5 nachleuchtenden Rillen
Farbton - dunkelgrau

stainless steel-enameled with 5 photoluminescent grooves, colour - dark grey

1,0	40085-1	66,30
2,0	72844-3	132,58
2,7 *	40095-0 *	179,02

40087-5	68,36
72846-7	136,74
40097-4 *	185,20

* Auslaufartikel / discontinued item

passende emaillierte Schrauben siehe Abschnitt 12/ suitable enameled screws see section 12

1. WINKELPROFILE + TREPPENKANTEN AUS ALUMINIUM + MESSING / 1. ANGLE EDGES + STAIR NOSINGS ALU + BRASS

Andere Eloxalfarben siehe Abschnitt 6, Lieferzeit 14 Tage
 other anodized colours see section 6, delivery time 14 days

Profi-Pack à 10 Stück im Bund			
professional packing à 10 pcs.			
Farbe/colour	L / l (m)	Art./ref.	€/Stk./pcs.

SB-Pack incl. Schr./ Dübel; VE 20 Stk.	
self-service-pack with screws/ dowels: à 20 pcs.	
Art./ref.	€/Stk./pcs.

91 Treppenkante 20 x 40 mm, Aluminium eloxiert, gebohrt

stair nosing 20 x 40 mm, aluminium anodized, drilled

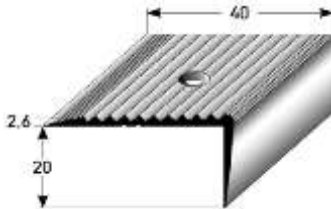

silberfarbig silver	0,8	07080-1	10,42		
	0,9	07090-0	11,74	07091-7	12,64
	1,0	07100-6	13,02	07101-3	13,96
	1,2	07110-5	15,60	07111-2	16,74
	2,0	07120-4	26,04	07121-1	27,92
	2,7	07130-3	35,18	07131-0	37,96
goldfarbig gold	0,8	07180-8	12,82		
	0,9	07190-7	14,38	07191-4	15,28
	1,0	07200-3	15,96	07201-0	16,98
	1,2	07210-2	19,16	07211-9	20,38
	2,0	07220-1	31,98	07221-8	34,04
	2,7	07230-0	43,16	07231-7	45,86
bronzefarbig hell bronze light	0,8	07280-5	13,96		
	0,9	07290-4	15,72	07291-1	17,02
	1,0	07300-0	17,44	07301-7	18,94
	1,2	07310-9	20,96	07311-6	22,76
	2,0	07320-8	34,86	07321-5	37,94
	2,7	07330-7	47,12	07331-4	51,14
bronzefarbig dunkel bronze dark	0,8	07380-2	13,96		
	0,9	07390-1	15,72	07391-8	16,60
	1,0	07400-7	17,44	07401-4	18,44
	1,2	07410-6	20,96	07411-3	22,14
	2,0	07420-5	34,86	07421-2	36,92
	2,7	07430-4	47,12	07431-1	49,82
MESSING poliert brass polished	1,0	28722-3	63,92	28723-0	65,14
	2,5	28720-9	159,80	28721-6	163,44

Bitte fordern Sie unsere Pflegehinweise für Messingprofile an!
 Please ask for our care tips for brass profiles!

97

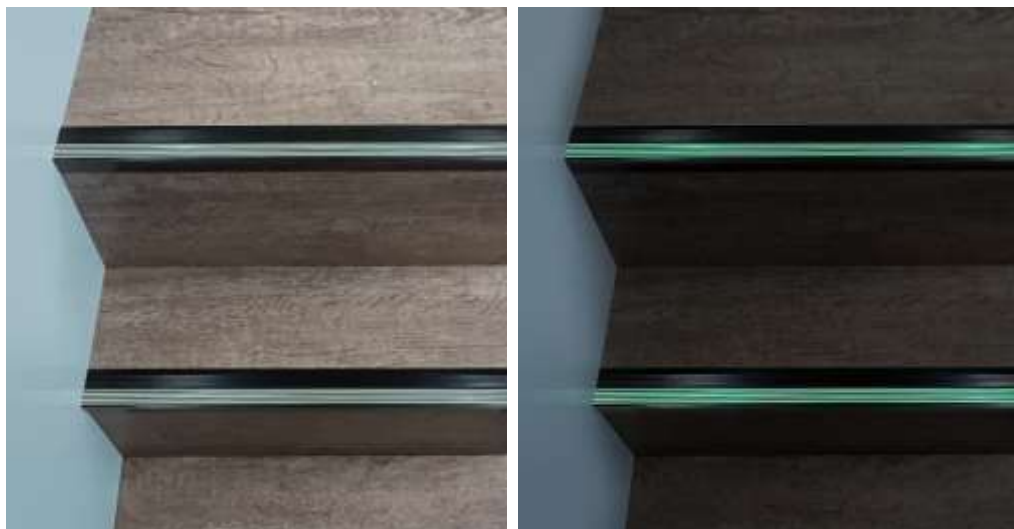

Beispiel: Treppenkante mit abriebfester und nachleuchtender Spezialmaillierung (91) für bodennahe Leitsysteme nach BGR 216.
 Leuchtzeit: 1 Stunde stark bei einer Mindestbeleuchtung von 100 Lux für ca. 5 Min. (siehe nächste Seite)

example: stair nosing with abrasion-resistant and special luminescent enamel (91) for floor-level guidance systems according to BGR 216.
 Lighting time: 1 hour strong with a minimum illumination of 100 lux for approx. 5 min. (see next page)

1. WINKELPROFILE + TREPPENKANTEN AUS ALUMINIUM + MESSING / 1. ANGLE EDGES + STAIR NOSINGS ALU + BRASS

Andere Eloxalfarben siehe
Abschnitt 6, Lieferzeit 14 Tage
other anodized colours see
section 6, delivery time 14 days

Profi-Pack à 10 Stück im Bund			
professional packing à 10 pcs.			
Farbe/colour	L / l (m)	Art./ref.	€/Stk./pcs.

SB-Pack incl. Schr./ Dübel; VE 20 Stk.	
self-service-pack with screws/ dowels; à 20 pcs.	
Art./ref.	€/Stk./pcs.

9 1 Treppenkante 20 x 40 mm, Aluminium mit abriebfester Spezialmaillierung, gebohrt

stair nosing 20 x 40 mm,
aluminium hard wearing
enamel, drilled

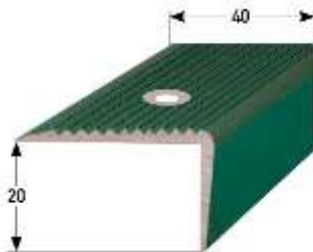

dunkelgrau dark grey	1,0	40000-4	37,08	40001-1	39,14
	2,0	72796-5	74,18	72798-9	78,30
	2,7 *	40010-3 *	100,12	40011-0 *	106,30
silber metallic silver metallic	1,0	40150-6	46,90	40152-0	48,96
	2,0	72800-9	93,80	72802-3	97,94
	2,7 *	40151-3 *	126,64	40153-7 *	132,84
gold gold	1,0 *	64000-4 *	45,30	64022-6 *	47,36
	2,7 *	64002-8 *	122,32	64024-0 *	128,50
blau blue	1,0	64004-2	45,30	64026-4	47,36
	2,0	72804-7	90,60	72806-1	94,74
	2,7 *	64006-6 *	122,32	64028-8 *	128,50
rot red	1,0 *	64008-0 *	45,30	64030-1 *	47,36
	2,7 *	64010-3 *	122,32	64032-5 *	128,50
grün green	1,0	64012-7	45,30	64034-9	47,36
	2,0	72808-5	90,60	72810-8	94,74
	2,7 *	64014-1 *	122,32	64036-3 *	128,50
schwarz black	1,0	64016-5	45,30	64038-7	47,36
	2,0	72812-2	90,60	72814-6	94,74
	2,7 *	64018-9 *	122,32	64040-0 *	128,50

* Auslaufartikel / discontinued item

9 1 Treppenkante 20 x 40 mm, Aluminium mit abriebfester Spezialmaillierung,

5 Rillen nachleuchtend, gebohrt

stair nosing 20 x 40 mm,
aluminium hard wearing
enamel, drilled, 5
photoluminescent grooves

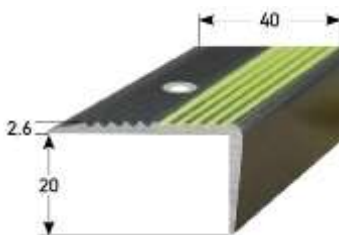

dunkelgrau dark grey	1,0	40005-9	64,30	40007-3	66,36
	2,0	72816-0	128,60	72818-4	132,74
	2,7 *	40015-8 *	173,62	40017-2 *	179,82
silber metallic silver metallic	1,0	40140-7	74,10	40144-5	76,18
	2,0	72820-7	148,24	72822-1	152,36
	2,7 *	40142-1 *	200,10	40146-9 *	206,32
gold gold	1,0 *	64044-8 *	72,52	64066-0 *	74,58
	2,7 *	64046-2 *	195,80	64068-4 *	202,02
blau blue	1,0	64048-6	72,52	64070-7	74,58
	2,0	72824-5	145,04	72826-9	149,18
	2,7 *	64050-9 *	195,80	64072-1 *	202,02
rot red	1,0 *	64052-3 *	72,52	64074-5 *	74,58
	2,7 *	64054-7 *	195,80	64076-9 *	202,02
grün green	1,0	64056-1	72,52	64078-3	74,58
	2,0	72828-3	145,04	72830-6	149,18
	2,7 *	64058-5 *	195,80	64080-6 *	202,02
schwarz black	1,0	64060-8	72,52	64082-0	74,58
	2,0	72832-0	145,04	72834-4	149,18
	2,7 *	64062-2 *	195,80	64084-4 *	202,02

* Auslaufartikel / discontinued item

1. WINKELPROFILE + TREPPENKANTEN AUS ALUMINIUM + MESSING / 1. ANGLE EDGES + STAIR NOSINGS ALU + BRASS

Andere Eloxalfarben siehe
Abschnitt 6, Lieferzeit 14 Tage
other anodized colours see
section 6, delivery time 14 days

Profi-Pack à 10 Stück im Bund			
professional packing à 10 pcs.			
Farbe/colour	L / l (m)	Art./ref.	€/Stk./pcs.

SB-Pack incl. Schr./ Dübel; VE 20 Stk.	
self-service-pack with screws/ dowels; à 20 pcs.	
Art./ref.	€/Stk./pcs.

8 4 Treppenkante 28 x 50 mm, Aluminium eloxiert, gebohrt

stair nosing 28 x 50 mm,
aluminium anodized, drilled

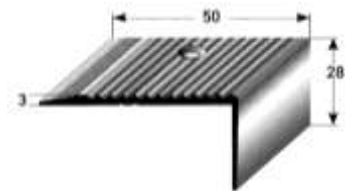

silberfarbig silver	1,0	31410-3	20,22
	2,7	31415-8	54,50
goldfarbig gold	1,0	31420-2	20,36
	2,7	31425-7	54,94
bronzef. hell bronze light	1,0	31430-1	23,78
	2,7	31435-6	64,34
bronzef. dunkel bronze dark	1,0	31440-0	23,78
	2,7	31445-5	64,34

31416-5	57,32
31426-4	57,66
31436-3	68,34
31446-2	67,02

Aluminium mit abriebfester Spezialmaillierung, gebohrt/ aluminium enameled, hard wearing, drilled

 **Edelstahl-Emaillbeschichtung**
Farbton - dunkelgrau
stainless steel-enameled, colour - dark grey

1,0	40040-0	44,28
2,0	72772-9	88,56
2,7 *	40050-9 *	119,56

40041-7	46,34
72774-3	92,68
40051-6 *	125,74

 **Emaillbeschichtung**
Farbton - silber metallic
stainless steel-enameled, colour - silver metallic

1,0	40190-2	54,10
2,0	72776-7	108,20
2,7 *	40191-9 *	146,08

40192-6	56,16
72778-1	112,34
40193-3 *	152,28

 **Edelstahl-Emaillbeschichtung**
mit 5 nachleuchtenden Rillen
Farbton - dunkelgrau

1,0	40045-5	71,50
2,0	72780-4	142,98
2,7 *	40055-4 *	193,06

40047-9	73,56
72782-8	147,12
40057-8 *	199,24

stainless steel-enameled with 5 photoluminescent grooves, colour - dark grey

* Auslaufartikel / discontinued item

passende emaillierte Schrauben siehe Abschnitt 12/ suitable enameled screws see section 12

8 3 Treppenkante 42 x 50 mm, Aluminium eloxiert, gebohrt

stair nosing 42 x 50 mm,
aluminium anodized, drilled

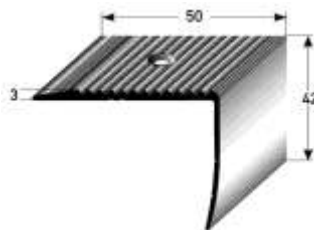

silberfarbig silver	1,0	07621-6	17,38
	2,5	07620-9	43,50
goldfarbig gold	1,0	07641-4	24,46
	2,5	07640-7	61,14
bronzef. hell bronze light	1,0	07661-2	28,60
	2,5	07660-5	71,60
bronzef. dunkel bronze dark	1,0	07681-0	28,60
	2,5	07680-3	71,60

07622-3	46,14
07642-1	63,84
07662-9	75,62
07682-7	74,32

Aluminium mit abriebfester Spezialmaillierung, gebohrt/ aluminium enameled, hard wearing, drilled

 **Edelstahl-Emaillbeschichtung**
Farbton - dunkelgrau
stainless steel-enameled, colour - dark grey

1,0	40020-2	41,44
2,0	72784-2	82,92
2,5 *	40030-1 *	103,66

40021-9	43,52
72786-6	87,04
40031-8 *	109,84

 **Emaillbeschichtung**
Farbton - silber metallic
stainless steel-enameled, colour - silver metallic

1,0	40170-4	51,28
2,0	72788-0	102,56
2,5 *	40171-1 *	128,20

40172-8	53,36
72790-3	106,68
40173-5 *	134,38

 **Edelstahl-Emaillbeschichtung**
mit 5 nachleuchtenden Rillen
Farbton - dunkelgrau

1,0	40025-7	68,66
2,0	72792-7	137,36
2,5 *	40035-6 *	171,70

40027-1	70,74
72794-1	141,48
40037-0 *	177,90

stainless steel-enameled with 5 photoluminescent grooves, colour - dark grey

* Auslaufartikel / discontinued item

passende emaillierte Schrauben siehe Abschnitt 12/ suitable enameled screws see section 12

1. WINKELPROFILE + TREPPENKANTEN AUS ALUMINIUM + MESSING / 1. ANGLE EDGES + STAIR NOSINGS ALU + BRASS

Andere Eloxfarben siehe
 Abschnitt 6, Lieferzeit 14 Tage
 other anodized colours see section 6,
 delivery time 14 days

Profi-Pack à 5 Stück im Bund			
professional packing à 5 pcs.			
Farbe/colour	L / l (m)	Art./ref.	€/Stk./pcs.

339 Treppenkante 55 x 69 mm, Aluminium eloxiert, gebohrt

stair nosing 55 x 69 mm, aluminium anodized, drilled

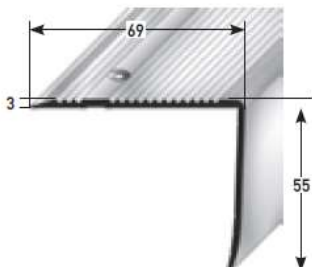

silberfarbig silver	1,0	65504-6	24,50
	2,7	65506-0	66,12
goldfarbig gold	1,0	65508-4	25,38
	2,7	65510-7	68,54
bronzef. hell bronze light	1,0	65512-1	28,42
	2,7	65514-5	76,72
bronzef. dunkel bronze dark	1,0	65516-9	28,42
	2,7	65518-3	76,72

passende Schrauben
 siehe Abschnitt 12
 suitable screws see
 section 12

127 Vorstoßprofil 2 x 25 mm, gebohrt

edge profile 2 x 25 mm,
 drilled

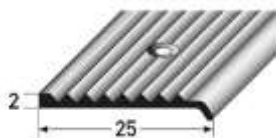

Profi-Pack à 10 Stück im Bund			
professional packing à 10 pcs.			
Farbe/colour	L / l (m)	Art./ref.	€/Stk./pcs.

SB-Pack incl. Schr./ Dübel; VE 20 Stk.	
self-service-pack with screws/ dowels; à 20 pcs.	
Art./ref.	€/Stk./pcs.

Alu silberfarbig silver	1,0	69960-6	6,36
	2,5	69962-0	15,86
Alu goldfarbig gold	1,0	69964-4	6,58
	2,5	69966-8	16,46
Alu bronze hell bronze light	1,0	69968-2	8,04
	2,5	69970-5	20,14
Alu bronze dunkel bronze dark	1,0	69972-9	8,04
	2,5	69974-3	20,14

69978-1	7,32
69980-4	18,76
69982-8	7,56
69984-2	19,38
69986-6	9,02
69988-0	23,20
69990-3	9,02
69992-7	23,20

MESSING poliert brass polished	1,0	28210-5	32,80
	2,0	28220-4	65,64
	2,5	28200-6	82,04

28211-2	34,26
28201-3	85,68

Bitte fordern Sie unsere Pflegehinweise für Messingprofile an!
 Please ask for our care tips for brass profiles!

129 Vorstoßprofil 3 x 30 mm, gebohrt

edge profile 3 x 30 mm,
 drilled



MESSING poliert brass polished	1,0	28630-1	36,12
	2,0	28640-0	72,20
	2,5	28650-9	90,26

28631-8	37,58
28651-6	94,02

Bitte fordern Sie unsere Pflegehinweise für Messingprofile an!
 Please ask for our care tips for brass profiles!

128 Vorstoßprofil 3 x 35 mm, gebohrt

edge profile 3 x 35 mm,
 drilled



Alu silberfarbig silver	1,0	28530-4	10,90
	2,5	28535-9	27,30
Alu goldfarbig gold	1,0	28540-3	11,26
	2,5	28545-8	28,24
Alu bronze hell bronze light	1,0	28550-2	13,00
	2,5	28555-7	32,52
Alu bronze dunkel bronze dark	1,0	28560-1	13,00
	2,5	28565-6	32,52

28531-1	11,96
28536-6	29,96
28541-0	12,36
28546-5	30,96
28551-9	14,64
28556-4	36,52
28561-8	14,10
28566-3	35,26

MESSING poliert brass polished	1,0	28610-3	46,14
	2,0	28620-2	92,24
	2,5	28600-4	115,32

28611-0	47,54
28601-1	118,98

Bitte fordern Sie unsere Pflegehinweise für Messingprofile an!
 Please ask for our care tips for brass profiles!

1. WINKELPROFILE + TREPPENKANTEN AUS ALUMINIUM + MESSING / 1. ANGLE EDGES + STAIR NOSINGS ALU + BRASS

Andere Eloxalfarben siehe
 Abschnitt 6, Lieferzeit 14 Tage
 other anodized colours see section 6,
 delivery time 14 days

Profi-Pack à 10 Stück im Bund			
professional packing à 10 pcs.			
Farbe/colour	L / l (m)	Art./ref.	€/Stk./pcs.

SB-Pack incl. Schr./ Dübel; VE 20 Stk.	
self-service-pack with screws/ dowels; à 20 pcs.	
Art./ref.	€/Stk./pcs.

474 Fassonprofil 2 mm, Aluminium eloxiert, gebohrt

fasson stair nosing 2 mm,
 aluminium anodized, drilled



silberfarbig silver	1,0	70700-4	6,20
	2,7	70702-8	16,72
goldfarbig gold	1,0	70704-2	6,52
	2,7	70706-6	17,62
bronzef. hell bronze light	1,0	70708-0	7,14
	2,7	70710-3	19,24
bronzef. dunkel bronze dark	1,0	70712-7	7,14
	2,7	70714-1	19,24

70716-5	7,18
70718-9	19,50
70720-2	7,54
70722-6	20,36
70724-0	8,60
70726-4	23,24
70728-8	8,16
70730-1	23,24

475 Fassonprofil 2,5 mm, Aluminium eloxiert, gebohrt

fasson stair nosing 2,5 mm,
 aluminium anodized, drilled



silberfarbig silver	1,0	70734-9	6,22
	2,7	70736-3	16,78
goldfarbig gold	1,0	70738-7	6,58
	2,7	70740-0	17,78
bronzef. hell bronze light	1,0	70742-4	7,18
	2,7	70744-8	19,40
bronzef. dunkel bronze dark	1,0	70746-2	7,18
	2,7	70748-6	19,40

70750-9	7,20
70752-3	19,60
70754-7	7,58
70756-1	20,50
70758-5	8,64
70760-8	23,42
70762-2	8,20
70764-6	23,42

476 Fassonprofil 3 mm, Aluminium eloxiert, gebohrt

fasson stair nosing 3 mm,
 aluminium anodized, drilled



silberfarbig silver	1,0	70768-4	6,26
	2,7	70770-7	16,92
goldfarbig gold	1,0	70772-1	6,62
	2,7	70774-5	17,90
bronzef. hell bronze light	1,0	70776-9	7,24
	2,7	70778-3	19,54
bronzef. dunkel bronze dark	1,0	70780-6	7,24
	2,7	70782-0	19,54

70784-4	7,26
70786-8	19,74
70788-2	7,62
70790-5	20,66
70792-9	8,70
70794-3	23,56
70796-7	8,24
70798-1	23,56



Befestigungsschenkel ausklinken attachment flanges notched
Befestigungsschenkel ausklinken und biegen attachment flanges notched and bent

Art./ref.	€/m
22240-8	7,16
auf Anfrage on request	

1. WINKELPROFILE + TREPPENKANTEN AUS ALUMINIUM + MESSING / 1. ANGLE EDGES + STAIR NOSINGS ALU + BRASS

Andere Eloxfarben siehe
Abschnitt 6, Lieferzeit 14 Tage
other anodized colours see
section 6, delivery time 14 days

Profi-Pack à 10 Stück im Bund			
professional packing à 10 pcs.			
Farbe/colour	L / l (m)	Art./ref.	€/Stk./pcs.

SB-Pack incl. Schr./ Dübel; VE 20 Stk.	
self-service-pack with screws/ dowels; à 20 pcs.	
Art./ref.	€/Stk./pcs.

435 Treppenkante 10 x 37 x 2 mm, Aluminium eloxiert, gebohrt

stair nosing 10 x 37 x 2 mm,
aluminium anodized, drilled

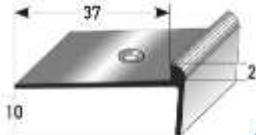

silberfarbig silver	1,0	68100-7	11,40	68118-2	12,42
	2,7	68102-1	30,82		68120-5
goldfarbig gold	1,0	68104-5	12,08	68122-9	13,06
	2,7	68106-9	32,58	68124-3	35,64
bronzef. hell bronze light	1,0	68108-3	13,58	68126-7	14,60
	2,7	68110-6	36,70	68128-1	39,76
bronzef. dunkel bronze dark	1,0	68112-0	13,58	68130-4	14,60
	2,7	68114-4	36,70	68132-8	39,76

68118-2	12,42
68120-5	33,86
68122-9	13,06
68124-3	35,64
68126-7	14,60
68128-1	39,76
68130-4	14,60
68132-8	39,76

436 Treppenkante 24 x 37 x 2 mm, Aluminium eloxiert, gebohrt

stair nosing 24 x 37 x 2 mm,
aluminium anodized, drilled

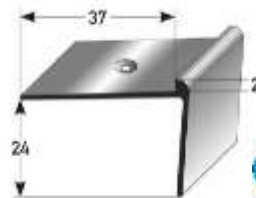

silberfarbig silver	1,0	68150-2	12,26	68168-7	13,30
	2,7	68152-6	33,14		68170-0
goldfarbig gold	1,0	68154-0	12,90	68172-4	13,94
	2,7	68156-4	34,82	68174-8	37,92
bronzef. hell bronze light	1,0	68158-8	14,50	68176-2	15,52
	2,7	68160-1	39,14	68178-6	42,22
bronzef. dunkel bronze dark	1,0	68162-5	14,50	68180-9	15,52
	2,7	68164-9	39,14	68182-3	42,22

68168-7	13,30
68170-0	36,22
68172-4	13,94
68174-8	37,92
68176-2	15,52
68178-6	42,22
68180-9	15,52
68182-3	42,22

266 Treppenkante 40 x 37 x 2 mm, Aluminium eloxiert, gebohrt

stair nosing 40 x 37 x 2 mm,
aluminium anodized, drilled



silberfarbig silver	1,0	46482-2	13,48	46486-0	14,50
	2,7	46480-8	36,40		46484-6
goldfarbig gold	1,0	46492-1	14,02	46496-9	15,04
	2,7	46490-7	37,96	46494-5	40,96
bronzef. hell bronze light	1,0	46502-7	15,92	46506-5	16,92
	2,7	46500-3	42,98	46504-1	45,98
bronzef. dunkel bronze dark	1,0	46512-6	15,92	46516-4	16,92
	2,7	46510-2	42,98	46514-0	45,98

46486-0	14,50
46484-6	39,44
46496-9	15,04
46494-5	40,96
46506-5	16,92
46504-1	45,98
46516-4	16,92
46514-0	45,98

383 Treppenkante 10 x 37 x 2,5 mm, Aluminium eloxiert, gebohrt

stair nosing 10 x 37 x 2,5 mm,
aluminium anodized, drilled

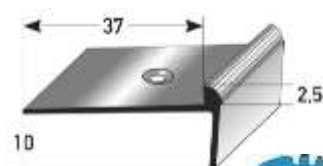

silberfarbig silver	1,0	66556-4	12,04	66580-9	13,04
	2,7	66558-8	32,56		66582-3
goldfarbig gold	1,0	66560-1	12,70	66584-7	13,70
	2,7	66562-5	34,24	66586-1	37,30
bronzef. hell bronze light	1,0	66564-9	14,20	66588-5	15,20
	2,7	66566-3	38,34	66590-8	41,36
bronzef. dunkel bronze dark	1,0	66568-7	14,20	66592-2	15,20
	2,7	66570-0	38,34	66594-6	41,36

66580-9	13,04
66582-3	35,56
66584-7	13,70
66586-1	37,30
66588-5	15,20
66590-8	41,36
66592-2	15,20
66594-6	41,36



Befestigungsschenkel ausklinken attachment flanges notched
Befestigungsschenkel ausklinken und biegen attachment flanges notched and bent

Art./ref.	€/m
22240-8	7,16
auf Anfrage on request	

1. WINKELPROFILE + TREPPENKANTEN AUS ALUMINIUM + MESSING / 1. ANGLE EDGES + STAIR NOSINGS ALU + BRASS

Andere Eloxfarben siehe
Abschnitt 6, Lieferzeit 14 Tage
other anodized colours see section 6,
delivery time 14 days

Profi-Pack à 10 Stück im Bund			
professional packing à 10 pcs.			
Farbe/colour	L / l (m)	Art./ref.	€/Stk./pcs.

SB-Pack incl. Schr./ Dübel; VE 20 Stk.	
self-service-pack with screws/ dowels; à 20 pcs.	
Art./ref.	€/Stk./pcs.

384 Treppenkante 24 x 37 x 2,5 mm, Aluminium eloxiert, gebohrt

stair nosing 24 x 37 x 2,5 mm,
aluminium anodized, drilled

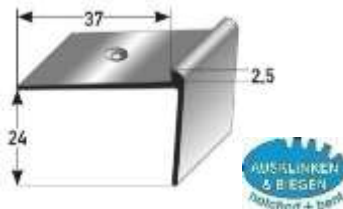

silberfarbig silver	1,0	66604-2	12,36
	2,7	66606-6	33,42
goldfarbig gold	1,0	66608-0	13,00
	2,7	66610-3	35,16
bronzef. hell bronze light	1,0	66612-7	14,58
	2,7	66614-1	39,38
bronzef. dunkel bronze dark	1,0	66616-5	14,58
	2,7	66618-9	39,38

66628-8	13,40
66630-1	36,46
66632-5	14,02
66634-9	38,16
66636-3	15,58
66638-7	42,42
66640-0	15,58
66642-4	42,42

385 Treppenkante 40 x 37 x 2,5 mm, Aluminium eloxiert, gebohrt

stair nosing 40 x 37 x 2,5 mm,
aluminium anodized, drilled

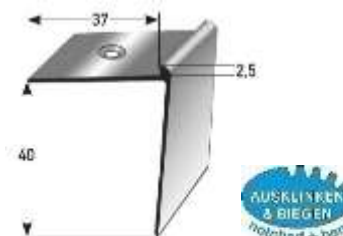

silberfarbig silver	1,0	66652-3	13,56
	2,7	66654-7	36,84
goldfarbig gold	1,0	66656-1	14,06
	2,7	66658-5	38,02
bronzef. hell bronze light	1,0	66660-8	16,76
	2,7	66662-2	45,24
bronzef. dunkel bronze dark	1,0	66664-6	16,76
	2,7	66666-0	45,24

66676-9	14,58
66678-3	39,90
66680-6	15,10
66682-0	41,06
66684-4	17,78
66686-8	48,24
66688-2	17,78
66690-5	48,24

437 Treppenkante 10 x 37 x 3 mm, Aluminium eloxiert, gebohrt

stair nosing 10 x 37 x 3 mm,
aluminium anodized, drilled

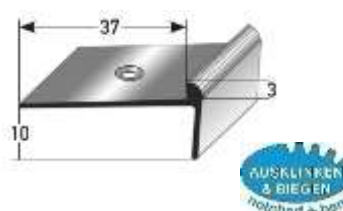

silberfarbig silver	1,0	68200-4	11,62
	2,7	68202-8	31,36
goldfarbig gold	1,0	68204-2	12,26
	2,7	68206-6	33,14
bronzef. hell bronze light	1,0	68208-0	13,74
	2,7	68210-3	37,10
bronzef. dunkel bronze dark	1,0	68212-7	13,74
	2,7	68214-1	37,10

68218-9	12,64
68220-2	34,42
68222-6	13,30
68224-0	36,22
68226-4	14,78
68228-8	40,18
68230-1	14,78
68232-5	40,18

9 4 Treppenkante 24 x 37 x 3 mm, Aluminium eloxiert, gebohrt

stair nosing 24 x 37 x 3 mm,
aluminium anodized, drilled

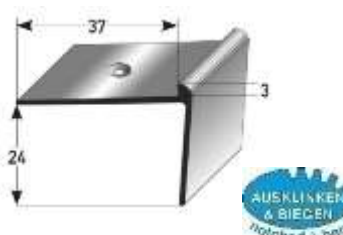

silberfarbig silver	1,0	35560-1	12,46
	2,7	35520-5	33,76
goldfarbig gold	1,0	35570-0	13,14
	2,7	35530-4	35,42
bronzef. hell bronze light	1,0	35580-9	14,64
	2,7	35540-3	39,46
bronzef. dunkel bronze dark	1,0	35590-8	14,64
	2,7	35550-2	39,46

35561-8	13,52
35521-2	36,52
35571-7	14,06
35531-1	38,16
35581-6	15,60
35541-0	42,24
35591-5	15,60
35551-9	42,24



Befestigungsschenkel ausklinken attachment flanges notched
Befestigungsschenkel ausklinken und biegen attachment flanges notched and bent

Art./ref.	€/m
22240-8	7,16
auf Anfrage on request	

1. WINKELPROFILE + TREPPENKANTEN AUS ALUMINIUM + MESSING / 1. ANGLE EDGES + STAIR NOSINGS ALU + BRASS

Andere Eloxafarben siehe
 Abschnitt 6, Lieferzeit 14 Tage
 other anodized colours see
 section 6, delivery time 14 days

Profi-Pack à 10 Stück im Bund			
professional packing à 10 pcs.			
Farbe/colour	L / l (m)	Art./ref.	€/Stk./pcs.

SB-Pack incl. Schr./ Dübel; VE 20 Stk.	
self-service-pack with screws/ dowels; à 20 pcs.	
Art./ref.	€/Stk./pcs.

341 Treppenkante 40 x 40 x 3 mm, Aluminium eloxiert, gebohrt

stair nosing 40 x 40 x 3 mm,
 aluminium anodized, drilled



silberfarbig silver	1,0	65750-7	13,60	65770-5	14,58
	2,7	65752-1	36,78		
goldfarbig gold	1,0	65754-5	14,14	65774-3	15,12
	2,7	65756-9	38,22		
bronzef. hell bronze light	1,0	65758-3	16,86	65776-7	41,16
	2,7	65760-6	45,52		
bronzef. dunkel bronze dark	1,0	65762-0	16,86	65778-1	17,82
	2,7	65764-4	45,52		
65780-4	48,40	65782-8	17,82	65784-2	48,40

65770-5	14,58
65772-9	39,64
65774-3	15,12
65776-7	41,16
65778-1	17,82
65780-4	48,40
65782-8	17,82
65784-2	48,40

537 Treppenkante 80 x 50 x 3 mm, Aluminium eloxiert, gebohrt

stair nosing 80 x 50 x 3 mm,
 aluminium anodized, drilled

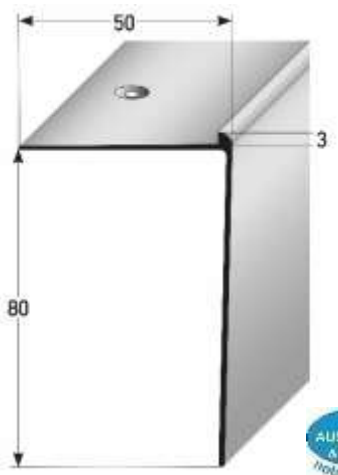

silberfarbig silver	1,0	72862-7	20,52	72878-8	21,48
	2,7	72864-1	55,40		
goldfarbig gold	1,0	72866-5	21,58	72880-1	58,26
	2,7	72868-9	58,26		
bronzef. hell bronze light	1,0	72870-2	24,08	72882-5	22,54
	2,7	72872-6	65,02		
bronzef. dunkel bronze dark	1,0	72874-0	24,08	72884-9	61,12
	2,7	72876-4	65,02		
72886-3	25,04	72888-7	67,88	72890-0	25,04

72878-8	21,48
72880-1	58,26
72882-5	22,54
72884-9	61,12
72886-3	25,04
72888-7	67,88
72890-0	25,04
72892-4	67,88

334 Treppenkante 10 x 37 x 5 mm, Aluminium eloxiert, gebohrt

stair nosing 10 x 37 x 5 mm,
 aluminium anodized, drilled



silberfarbig silver	1,0	65350-9	12,56	65354-7	13,56
	2,7	65352-3	34,00		
goldfarbig gold	1,0	65360-8	13,22	65356-1	36,98
	2,7	65362-2	35,66		
bronzef. hell bronze light	1,0	65370-7	14,70	65364-6	14,20
	2,7	65372-1	39,74		
bronzef. dunkel bronze dark	1,0	65380-6	14,70	65366-0	38,64
	2,7	65382-0	39,74		
65374-5	15,72	65376-9	42,72	65384-4	15,72

65354-7	13,56
65356-1	36,98
65364-6	14,20
65366-0	38,64
65374-5	15,72
65376-9	42,72
65384-4	15,72
65386-8	42,72



Befestigungsschenkel ausklinken attachment flanges notched
Befestigungsschenkel ausklinken und biegen attachment flanges notched and bent

Art./ref.	€/m
22240-8	7,16
auf Anfrage on request	

1. WINKELPROFILE + TREPPENKANTEN AUS ALUMINIUM + MESSING / 1. ANGLE EDGES + STAIR NOSINGS ALU + BRASS

Andere Eloxalfarben siehe
Abschnitt 6, Lieferzeit 14 Tage
other anodized colours see
section 6, delivery time 14 days

Profi-Pack à 10 Stück im Bund			
professional packing à 10 pcs.			
Farbe/colour	L / l (m)	Art./ref.	€/Stk./pcs.

SB-Pack incl. Schr./ Dübel; VE 20 Stk.	
self-service-pack with screws/ dowels; à 20 pcs.	
Art./ref.	€/Stk./pcs.

267 Treppenkante 24 x 37 x 5 mm, Aluminium eloxiert, gebohrt

stair nosing 24 x 37 x 5 mm,
aluminium anodized, drilled



silberfarbig silver	1,0	46522-5	12,72
	2,7	46520-1	34,32
goldfarbig gold	1,0	46532-4	13,34
	2,7	46530-0	36,00
bronzef. hell bronze light	1,0	46542-3	14,84
	2,7	46540-9	40,12
bronzef. dunkel bronze dark	1,0	46552-2	14,84
	2,7	46550-8	40,12

46526-3	13,72
46524-9	37,32
46536-2	14,36
46534-8	39,06
46546-1	15,86
46544-7	43,16
46556-0	15,86
46554-6	43,16

340 Treppenkante 40 x 40 x 5 mm, Aluminium eloxiert, gebohrt

stair nosing 40 x 40 x 5 mm,
aluminium anodized, drilled



silberfarbig silver	1,0	65708-8	13,96
	2,7	65710-1	37,64
goldfarbig gold	1,0	65712-5	14,52
	2,7	65714-9	39,20
bronzef. hell bronze light	1,0	65716-3	17,26
	2,7	65718-7	46,64
bronzef. dunkel bronze dark	1,0	65720-0	17,26
	2,7	65722-4	46,64

65728-6	14,94
65730-9	40,54
65732-3	15,50
65734-7	42,12
65736-1	18,22
65738-5	49,54
65740-8	18,22
65742-2	49,54

333 Treppenkante 10 x 37 x 7 mm, Aluminium eloxiert, gebohrt

stair nosing 10 x 37 x 7 mm,
aluminium anodized, drilled

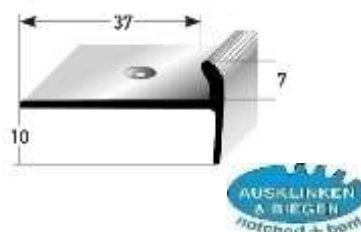

silberfarbig silver	1,0	65300-4	12,72
	2,7	65302-8	34,32
goldfarbig gold	1,0	65310-3	13,34
	2,7	65312-7	36,00
bronzef. hell bronze light	1,0	65320-2	14,84
	2,7	65322-6	40,12
bronzef. dunkel bronze dark	1,0	65330-1	14,84
	2,7	65332-5	40,12

65304-2	13,72
65306-6	37,32
65314-1	14,36
65316-5	39,06
65324-0	15,86
65326-4	43,16
65334-9	15,86
65336-3	43,16

496 wendbares Treppenseitenprofil 3 / 5 mm, Aluminium eloxiert, ungebohrt

turnable stair side profile
3 / 5 mm, aluminium
anodized, undrilled



silberfarbig silver	2,7	71330-2	16,26
		71332-6	16,56
bronzef. hell bronze light	2,7	71334-0	20,16
		71336-4	20,16

71338-8	17,02
71340-1	17,30
71342-5	20,92
71344-9	20,92



Befestigungsschenkel ausklinken attachment flanges notched
Befestigungsschenkel ausklinken und biegen attachment flanges notched and bent

Art./ref.	€/m
22240-8	7,16
auf Anfrage on request	

1. WINKELPROFILE + TREPPENKANTEN AUS ALUMINIUM + MESSING / 1. ANGLE EDGES + STAIR NOSINGS ALU + BRASS

Andere Eloxfarben siehe
Abschnitt 6, Lieferzeit 14 Tag/
other anodized colours see
section 6, delivery time 14 days

Treppeninnenecken aus Aluminium			
stair inside corners out of aluminium			
Profi-Pack à 10 Stück im Bund			
professional packing à 10 pcs.			
Farbe/colour	L / l (m)	Art./ref.	€/Stk./pcs.
SB-Pack incl. Schr./ Dübel; VE 20 Stk.		self-service-pack with screws/ dowels; à 20 pcs.	
Art./ref.		€/Stk./pcs.	

369 Treppeninnenecke 3 mm, Aluminium eloxiert, gebohrt

stair inside corner 3 mm,
aluminium anodized, drilled

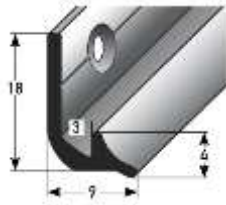

silberfarbig silver	1,0	66426-0	6,46	66427-7	7,46
	2,7	66428-4	17,48	66429-1	20,52
goldfarbig gold	1,0	66430-7	6,66	66431-4	7,66
	2,7	66432-1	17,98	66433-8	20,98
bronzef. hell bronze light	1,0	66434-5	7,30	66435-2	8,32
	2,7	66436-9	19,70	66437-6	22,76
bronzef. dunkel bronze dark	1,0	66438-3	7,30	66439-0	8,32
	2,7	66440-6	19,70	66441-3	22,76

370 Treppeninnenecke 5 mm, Aluminium eloxiert, gebohrt

stair inside corner 5 mm,
aluminium anodized, drilled

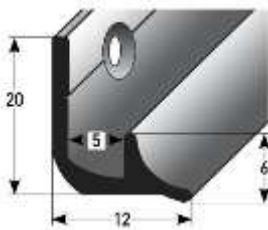

silberfarbig silver	1,0	66444-4	7,40	66445-1	8,42
	2,7	66446-8	19,98	66447-5	23,02
goldfarbig gold	1,0	66448-2	7,62	66449-9	8,62
	2,7	66450-5	20,56	66451-2	23,62
bronzef. hell bronze light	1,0	66452-9	8,22	66453-6	9,22
	2,7	66454-3	22,22	66455-0	25,24
bronzef. dunkel bronze dark	1,0	66456-7	8,22	66457-4	9,22
	2,7	66458-1	22,22	66459-8	25,24

Beispiel: Treppeninnenecke 5 mm,
Aluminium eloxiert, gebohrt,
siehe oben
example: stair inside corner 5 mm,
aluminium anodized, drilled,
see above



1. WINKELPROFILE + TREPPENKANTEN AUS ALUMINIUM + MESSING / 1. ANGLE EDGES + STAIR NOSINGS ALU + BRASS

Profi-Pack à 10 Stück im Bund			
professional packing à 10 pcs.			
Farbe/colour	L / l (m)	Art./ref.	€/Stk./pcs.

SB-Pack incl. Schr./ Dübel; VE 20 Stk.	
self-service-pack with screws/ dowels; à 20 pcs.	
Art./ref.	€/Stk./pcs.

205 Treppenkante 10 x 30 x 1,2 mm, Messing poliert, profilierte Riffelung, gebohrt

stair nosing 10 x 30 x 1,2 mm,
brass polished, fluted profile,
drilled

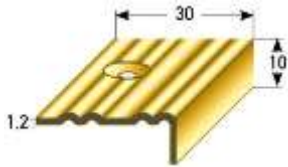

MESSING poliert brass polished	1,0	61850-8	19,96
	2,7	61870-6	53,90

61860-7	21,86
61880-5	58,86

Bitte fordern Sie unsere Pflegehinweise für Messingprofile an!
 Please ask for our care tips for brass profiles!

270 Treppenkante 20 x 40 x 1,5 mm, Messing matt, profilierte Riffelung, gebohrt

stair nosing 20 x 40 x 1,5 mm,
brass matt, fluted profile, drilled

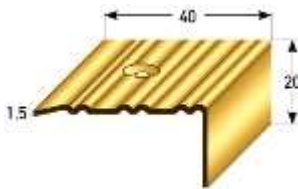

MESSING matt brass matt	1,0	46600-0	41,96
	2,0	46602-4	83,86

46604-8	43,06
46606-2	86,14

Bitte fordern Sie unsere Pflegehinweise für Messingprofile an!
 Please ask for our care tips for brass profiles!

271 Treppenkante 40 x 40 x 1,5 mm, Messing matt, profilierte Riffelung, gebohrt

stair nosing 40 x 40 x 1,5 mm,
brass matt, fluted profile, drilled

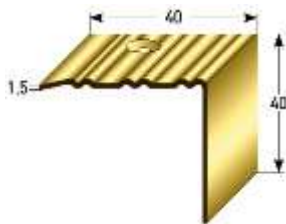

MESSING matt brass matt	1,0	46610-9	54,70
	2,0	46612-3	109,44

46614-7	55,86
46616-1	111,74

Bitte fordern Sie unsere Pflegehinweise für Messingprofile an!
 Please ask for our care tips for brass profiles!

9 8 Treppenkante 15 x 35 mm, Messing poliert, gebohrt

stair nosing 15 x 35 mm,
brass polished, drilled



MESSING poliert brass polished	1,0	28712-4	54,04
	2,5	28710-0	135,10

28713-1	55,26
28711-7	138,72

Bitte fordern Sie unsere Pflegehinweise für Messingprofile an!
 Please ask for our care tips for brass profiles!

1. WINKELPROFILE + TREPPENKANTEN AUS ALUMINIUM + MESSING / 1. ANGLE EDGES + STAIR NOSINGS ALU + BRASS

Andere Eloxalfarben siehe
Abschnitt 6, Lieferzeit 14 Tage
other anodized colours see
section 6, delivery time 14 days

Profi-Pack à 10 Stück im Bund			
professional packing à 10 pcs.			
Farbe/colour	L / l (m)	Art./ref.	€/Stk./pcs.

SB-Pack incl. Schr./ Dübel; VE 20 Stk.	
self-service-pack with screws/ dowels; à 20 pcs.	
Art./ref.	€/Stk./pcs.

82 Kombi-Treppenkante 23 x 40 mm, Aluminium eloxiert, gebohrt

combination stair nosing
23 x 40 mm, aluminium
anodized, drilled

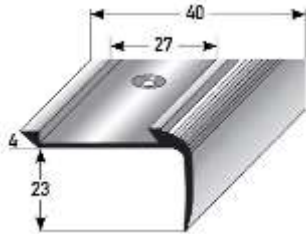

silberfarbig silver	1,0	07501-1	14,98		
	2,5	07500-4	37,42	07502-8	40,12
goldfarbig gold	1,0	07521-9	15,22		
	2,5	07520-2	38,16	07522-6	40,86
bronzef. hell bronze light	1,0	07541-7	17,32		
	2,5	07540-0	43,36	07542-4	46,16
bronzef. dunkel bronze dark	1,0	07561-5	17,32		
	2,5	07560-8	43,36	07562-2	46,16

passend für Einlage 27 mm, siehe Nr. 121, Seite 22
suitable for insert 27 mm, see no. 121, page 22

81 Kombi-Treppenkante 27 x 58 mm, Aluminium eloxiert, gebohrt

combination stair nosing
27 x 58 mm, aluminium
anodized, drilled

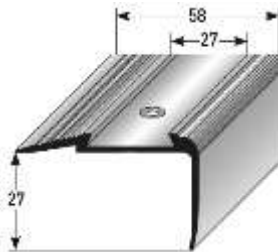

silberfarbig silver	1,0	07941-5	15,84		
	2,5	07940-8	39,60	07942-2	42,16
goldfarbig gold	1,0	07951-4	19,82		
	2,5	07950-7	49,58	07952-1	52,30
bronzef. hell bronze light	1,0	07961-3	21,94		
	2,5	07960-6	54,82	07962-0	57,56
bronzef. dunkel bronze dark	1,0	07971-2	21,94		
	2,5	07970-4	54,82	07972-9	57,56

passend für Einlage 27 mm, siehe Nr. 121, Seite 22
suitable for insert 27 mm, see no. 121, page 22

Aluminium mit abriebfester Spezialmaillierung, gebohrt/ aluminium enameled, hard wearing, drilled

 Edelst.-Emaillbeschichtung Farbton - dunkelgrau stainless steel-enameled, colour - dark grey	1,0	40100-1	39,90	40101-8	41,98
	2,0	72764-4	79,80	72766-8	83,94
	2,5 *	40110-0 *	99,76	40111-7 *	105,96

 Emaillbeschichtung Farbton - silber metallic stainless steel-enameled, colour - silver metallic	1,0	40250-3	49,74	40252-7	51,78
	2,0	72768-2	99,44	72770-5	103,58
	2,5 *	40251-0 *	124,30	40253-4 *	130,52

* **Auslaufartikel** / discontinued item

147 Kombi-Treppenkante 45 x 58 mm, Aluminium eloxiert, gebohrt

combination stair nosing
45 x 58 mm, aluminium
anodized, drilled

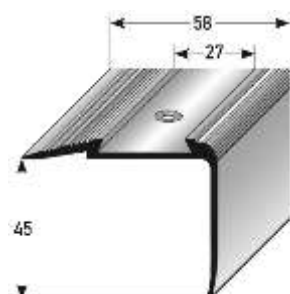

silberfarbig silver	1,0	42700-1	21,64		
	2,7	42705-6	58,46	42710-0	61,24
goldfarbig gold	1,0	42715-5	22,92		
	2,7	42720-9	61,70	42725-4	64,42
bronzef. hell bronze light	1,0	42730-8	25,24		
	2,7	42735-3	68,26	42740-7	70,94
bronzef. dunkel bronze dark	1,0	42745-2	25,24		
	2,7	42750-6	68,26	42755-1	70,94

passend für Einlage 27 mm, siehe Nr. 121, Seite 22
suitable for insert 27 mm, see no. 121, page 22

1. WINKELPROFILE + TREPPENKANTEN AUS ALUMINIUM + MESSING / 1. ANGLE EDGES + STAIR NOSINGS ALU + BRASS

Andere Eloxfarben siehe Abschnitt 6,
Lieferzeit 14 Tage
other anodized colours see section 6,
delivery time 14 days

Profi-Pack à 10 Stück im Bund			
professional packing à 10 pcs.			
Farbe/colour	L / l (m)	Art./ref.	€/Stk./pcs.

SB-Pack incl. Schr./ Dübel; VE 20 Stk.	
self-service-pack with screws/ dowels; à 20 pcs.	
Art./ref.	€/Stk./pcs.

146 Kombi-Treppenkante 80 x 58 mm, Aluminium eloxiert, gebohrt

combination stair nosing 80 x 58 mm,
aluminium anodized, drilled



silberfarbig silver	1,0	42760-5	29,40	42770-4	82,10
	2,7	42765-0	79,38		
goldfarbig gold	1,0	42775-9	31,00	42785-8	86,54
	2,7	42780-3	83,80		
bronzef. hell bronze light	1,0	42790-2	34,32	42800-8	95,32
	2,7	42795-7	92,60		
bronzef. dunkel bronze dark	1,0	42805-3	34,32	42815-2	95,32
	2,7	42810-7	92,60		

42770-4	82,10
42785-8	86,54
42800-8	95,32
42815-2	95,32

passend für Einlage 27 mm, siehe Nr. 121, unten/ suitable for insert 27 mm, no. 121, see below

Der lange Schenkel kann gekürzt werden./ The long side can be shortened on request.

121 PVC-Einlage 27 mm, Weich-PVC

für Kombi-Treppenkanten
Nr. 81, 82, 146 und 147

PVC-insert 27 mm for
combination stair nosing
no. 81, 82, 146 +147
made of soft PVC

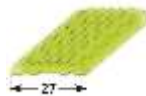

Farbe/colour	L / l (m)	eben/ smooth		Art./ref.	€/Stk./pcs.
		Art./ref.	€/Stk./pcs.		
grau/ grey	25 m	55301-4	3,32/m	83,12/Ro.	
schwarz/ black		55302-1			
braun/ brown		55303-8			
beige/ beige		55304-5			
rot/ red		55309-0			
blau/ blue		55300-7			

Art./ref.	€/Stk./pcs.
56302-0	
56303-7	
56304-4	
56309-9	
56300-6	

Extrem nachleuchtend extremely photoluminescent	25 m	mit extremer Leuchtkraft with extreme luminosity	40135-3	22,62/m
--	------	---	---------	---------

40135-3	22,62/m
	565,48/Ro.

Für Zuschnitte erheben wir einen Arbeitsaufschlag von 15 %./ For cuttings we charge a labor surcharge of 15%.

Montagehinweis: Bei der Montage sind die Enden der Einlagen mit Montagekleber an der Schiene zu befestigen.
Installation advice: Fix the ends of the inserts at the profile with installation glue.

Profi-Pack à 10 Stück im Bund			
professional packing à 10 pcs.			
Farbe/colour	L / l (m)	Art./ref.	€/Stk./pcs.

SB-Pack incl. Schr./ Dübel; VE 20 Stk.	
self-service-pack with screws/ dowels; à 20 pcs.	
Art./ref.	€/Stk./pcs.

92 Treppenkante 15 x 36 mm, Aluminium eloxiert, gebohrt, passend für Einlage 12 mm, siehe unten

stair nosing 15 x 36 mm,
aluminium anodized, drilled,
suitable for insert 12 mm, see below

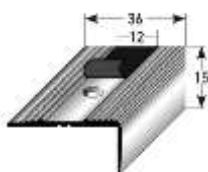

silberfarbig silver	1,0	07710-7	11,12	07711-4	12,12
	2,7	07720-6	29,90		
goldfarbig gold	1,0	07730-5	11,46	07731-2	12,46
	2,7	07740-4	30,98		
bronzef. hell bronze light	1,0	07750-3	13,16	07751-0	14,14
	2,7	07760-2	35,50		
bronzef. dunkel bronze dark	1,0	07770-1	13,16	07771-8	14,14
	2,7	07780-0	35,50		

07711-4	12,12
07721-3	32,60
07731-2	12,46
07741-1	33,72
07751-0	14,14
07761-9	38,30
07771-8	14,14
07781-7	38,30

486 Easy-Clean-Einlage 12 mm, rau,

selbstklebend, für Treppenkante Nr. 92

easy-clean insert 12 mm,
self-adhesive, rough,
for stair nosing no. 92



Farbe/colour	L / l (m)	Art./ref.	€
schwarz/ black	Rolle/ roll à 25 m	71100-1	2,70/m
grau/ grey		71102-5	67,50/Ro.
gelb-schwarz yellow-black		71104-9	2,88/m 71,84/Ro.

Für Zuschnitte erheben wir einen Arbeitsaufschlag von 15 %.
For cuttings we charge a labor surcharge of 15%.

Achtung! Verlegeanleitung für Einlagen beachten! Siehe Abschnitt 13.
Attention! Please follow the installation advice in section 13.

1. WINKELPROFILE + TREPPENKANTEN AUS ALUMINIUM + MESSING / 1. ANGLE EDGES + STAIR NOSINGS ALU + BRASS

Andere Eloxalfarben siehe
 Abschnitt 6, Lieferzeit 14 Tage/
 other anodized colours see
 section 6, delivery time 14 days

Profi-Pack à 10 Stück im Bund			
professional packing à 10 pcs.			
Farbe/colour	L / l (m)	Art./ref.	€/Stk./pcs.

SB-Pack incl. Schr./ Dübel; VE 20 Stk.	
self-service-pack with screws/ dowels; à 20 pcs.	
Art./ref.	€/Stk./pcs.

373 Treppenkante 39 x 48 mm, Aluminium eloxiert, gebohrt

stair nosing 39 x 48 mm,
 aluminium anodized, drilled

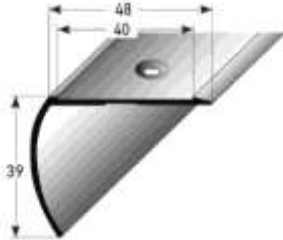

silberfarbig silver	1,0	66362-1	14,96
	2,7	66364-5	40,32
goldfarbig gold	1,0	66368-3	15,58
	2,7	66370-6	42,12
bronzef. hell bronze light	1,0	66374-4	17,74
	2,7	66376-8	47,94
bronzef. dunkel bronze dark	1,0	66380-5	17,74
	2,7	66382-9	47,94

66366-9	43,36
66372-0	45,14
66378-2	50,94
66384-3	50,94

passend für Einlage 39 mm, Nr. 375+487, siehe unten/ suitable for insert 39 mm, no. 375+487, see below .

374 Treppenkante 43 x 50 mm, Aluminium eloxiert, gebohrt

stair nosing 43 x 50 mm,
 aluminium anodized, drilled

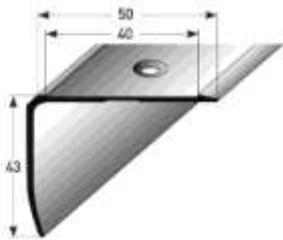

silberfarbig silver	1,0	66388-1	15,82
	2,7	66390-4	42,72
goldfarbig gold	1,0	66394-2	18,10
	2,7	66396-6	48,86
bronzef. hell bronze light	1,0	66400-0	18,72
	2,7	66402-4	50,60
bronzef. dunkel bronze dark	1,0	66406-2	18,72
	2,7	66408-6	50,60

66392-8	45,72
66398-0	51,90
66404-8	53,60
66410-9	53,60

passend für Einlage 39 mm, Nr. 375+487, siehe unten/ suitable for insert 39 mm, no. 375+487, see below .

375 Easy-Clean-Einlage 39 mm, rau, selbstklebend

easy-clean insert 39 mm,
 rough, self-adhesive



Farbe/colour	L / l (m)	Art./ref.	€
schwarz/ black	25 m	66416-1	3,22/m 80,62/Ro.
grau/ grey		66414-7	
gelb-schwarz yellow-black		66418-5	3,82/m 95,60/Ro.

487 Anti-Rutsch-Einlage 39 mm, grobe Körnung K60, selbstklebend

anti-slip insert 39 mm,
 coarse grain K60,
 self-adhesive

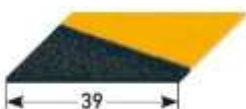

schwarz/ black	25 m	71110-0	3,22/m 80,62/Ro.
grau/ grey		71112-4	
braun/ brown		71114-8	
gelb-schwarz yellow-black		71116-2	3,82/m 95,60/Ro.

Für Zuschnitte erheben wir einen Arbeitsaufschlag von 15 %.
 For cuttings we charge a labor surcharge of 15%.

Achtung!! Bitte die Verlegeanleitung für Einlagen beachten! Siehe Abschnitt 13.
 Attention!! Please follow the installation advice in section 13.

passend für Übergangsprofil Nr. 412 & Treppenkanten Nr. 373/ 374/ 394-396
 suitable for connecting profile no. 412 and stair nosing no. 373/ 374/ 394-396

1. WINKELPROFILE + TREPPENKANTEN AUS ALUMINIUM + MESSING / 1. ANGLE EDGES + STAIR NOSINGS ALU + BRASS

Andere Eloxalfarben siehe
 Abschnitt 6, Lieferzeit 14 Tage/
 other anodized colours see
 section 6, delivery time 14 days

Profi-Pack à 10 Stück im Bund			
professional packing à 10 pcs.			
Farbe/colour	L / l (m)	Art./ref.	€/Stk./pcs.

SB-Pack incl. Schr./ Dübel; VE 20 Stk.	
self-service-pack with screws/ dowels; à 20 pcs.	
Art./ref.	€/Stk./pcs.

500 Treppenkante 30 x 60 mm, Aluminium eloxiert, gebohrt

stair nosing 30 x 60 mm,
 aluminium anodized, drilled



silberfarbig silver	1,0	71534-4	16,94
	2,7	71536-8	45,76
goldfarbig gold	1,0	71538-2	17,60
	2,7	71540-5	47,52
bronzef. hell bronze light	1,0	71542-9	19,14
	2,7	71544-3	51,70
bronzef. dunkel bronze dark	1,0	71546-7	19,82
	2,7	71548-1	53,52

71550-4	17,94
71552-8	48,70
71554-2	18,58
71556-6	50,42
71558-0	20,12
71560-3	54,60
71562-7	20,80
71564-1	56,42

Gemäß DIN 18040-2 "Barrierefreies Bauen" kann auf der Setzstufe eine 23 mm-Einlage verklebt werden.
 According to DIN 18040-2 "barrier-free construction" a 23 mm insert can be glued on the riser.

passend für 50 mm-Einlage, Nr. 504+505, auf Trittstufe und 23 mm-Einlage, Nr. 489+490, an Setzstufe, siehe unten & nächste Seite/ suitable for tread insert 50 mm, no.504+505, and for riser 23 mm insert,no. 489+490, see below and next page

504 Easy-Clean-Einlage 50 mm, rau, selbstklebend

easy-clean insert 50 mm,
 rough, self-adhesive



Farbe/colour	L / l (m)	Art./ref.	€
schwarz/ black	25 m	71570-2	4,12/m
grau/ grey		71572-6	103,10/Ro.
gelb-schwarz yellow-black		71574-0	4,90/m 122,48/Ro.

505 Anti-Rutsch-Einlage 50 mm, grobe Körnung K60, selbstklebend

anti-slip insert 50 mm,
 coarse grain K60,
 self-adhesive

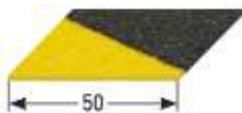

schwarz/ black	25 m	71580-1	4,12/m
grau/ grey		71582-5	103,10/Ro.
gelb-schwarz yellow-black		71584-9	4,90/m 122,48/m

Für Zuschnitte erheben wir einen Arbeitsaufschlag von 15 %. / For cuttings we charge a labor surcharge of 15%.

passend für Treppenkante Nr. 500
 suitable for stair nosing nr. 500

Achtung!! Bitte die Verlegeanleitung für Einlagen beachten!
Siehe Abschnitt 13. / Attention!! Please follow the installation advice in section 13.

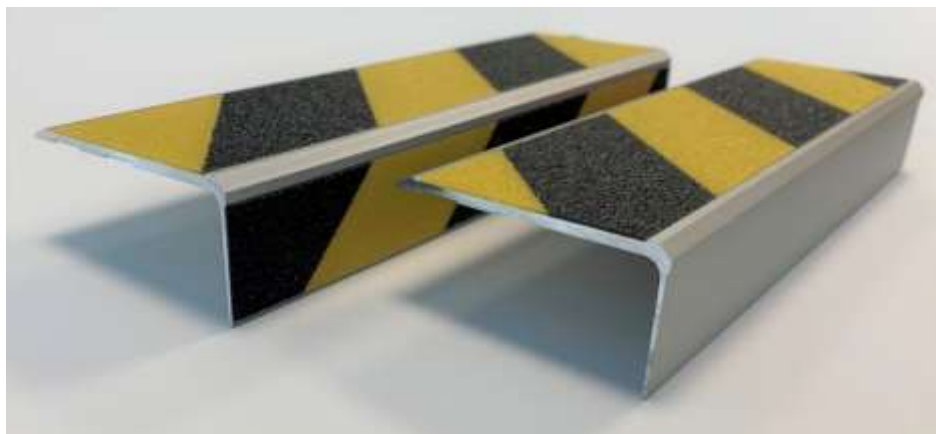

Beispiel: Treppenkanten 30 x 60 mm mit Einlage 50 mm gelb-schwarz beklebt, ohne und mit Setzstufenbeklebung mit 23 mm Einlage

example: stair nosings 30 x 60 mm with 50 mm yellow-black insert, without and with 23 mm insert on the riser

1. WINKELPROFILE + TREPPENKANTEN AUS ALUMINIUM + MESSING / 1. ANGLE EDGES + STAIR NOSINGS ALU + BRASS

Andere Eloxafarben siehe
Abschnitt 6, Lieferzeit 14 Tage/
other anodized colours see
section 6, delivery time 14 days

Profi-Pack à 10 Stück im Bund			
professional packing à 10 pcs.			
Farbe/colour	L / l (m)	Art./ref.	€/Stk./pcs.

SB-Pack incl. Schr./ Dübel; VE 20 Stk.	
self-service-pack with screws/ dowels; à 20 pcs.	
Art./ref.	€/Stk./pcs.

86 Treppenkante 28,5 x 53 mm, Aluminium eloxiert, gebohrt

stair nosing 28,5 x 53 mm,
aluminium anodized, drilled

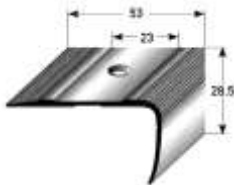

silberfarbig silver	1,0	35440-6	18,30		
	2,7	35400-0	49,40	35401-7	52,14
goldfarbig gold	1,0	35450-5	18,92		
	2,7	35410-9	50,96	35411-6	53,70
bronzef. hell bronze light	1,0	35460-4	21,46		
	2,7	35420-8	58,02	35421-5	60,76
bronzef. dunkel bronze dark	1,0	35470-3	21,46		
	2,7	35430-7	58,02	35431-4	60,76

passend für Einlage 23 mm, Nr. 489+490, siehe unten/ suitable for insert 23 mm, no. 489+490, see below

80 Treppenkante 28,5 x 75 mm, Aluminium eloxiert, gebohrt

stair nosing 28,5 x 75 mm,
aluminium anodized, drilled

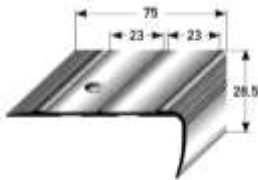

silberfarbig silver	1,0	39660-4	21,94		
	2,7	39670-3	59,20	39671-0	61,94
goldfarbig gold	1,0	39680-2	22,76		
	2,7	39690-1	61,38	39691-8	64,14
bronzef. hell bronze light	1,0	39700-7	25,44		
	2,7	39710-6	68,80	39711-3	71,52
bronzef. dunkel bronze dark	1,0	39720-5	25,44		
	2,7	39730-4	68,80	39731-1	71,52

passend für Einlage 23 mm, Nr. 489+490, siehe unten/ suitable for insert 23 mm, no. 489+490, see below

Achtung: doppelte Menge der Einlage berücksichtigen/ Attention: Consider double amount of insert!

489 Easy-Clean-Einlage 23 mm, rau, selbstklebend

easy-clean insert 23 mm,
self-adhesive, rough



Farbe/colour	L / l (m)	Art./ref.	€
schwarz/ black	Rolle/ roll à 25 m	71122-3	2,96/m
grau/ grey		71124-7	73,74/Ro.
gelb-schwarz yellow-black		71126-1	3,24/m
			81,22/Ro.

für Treppenkanten Nr. 80 / 86 / 500
for stair nosings no. 80 / 86 / 500

490 Anti-Rutsch-Einlage 23 mm, grobe Körnung K60, selbstklebend,

anti-slip insert 23 mm,
coarse grain K60,
self-adhesive



schwarz/ black	Rolle/ roll à 25 m	71132-2	2,96/m
grau/ grey		71134-6	73,74/Ro.
braun/ brown		71136-0	
gelb-schwarz yellow-black		71138-4	3,24/m 81,22/Ro.

für Treppenkanten Nr. 80 / 86 / 500
for stair nosings no. 80 / 86 / 500

Für Zuschnitte erheben wir einen Arbeitsaufschlag von 15 %./ For cuttings we charge a labor surcharge of 15%.

Achtung! Verlegeanleitung für Einlagen beachten! Siehe Abschnitt 13.
Attention! Please follow the installation advice in section 13.

1. WINKELPROFILE + TREPPENKANTEN AUS ALUMINIUM + MESSING / 1. ANGLE EDGES + STAIR NOSINGS ALU + BRASS

Andere Eloxalfarben siehe
Abschnitt 6, Lieferzeit 14 Tage/
other anodized colours see section 6,
delivery time 14 days

Profi-Pack à 10 Stück im Bund			
professional packing à 10 pcs.			
Farbe/colour	L / l (m)	Art./ref.	€/Stk./pcs.

SB-Pack incl. Schr./ Dübel; VE 20 Stk.	
self-service-pack with screws/ dowels; à 20 pcs.	
Art./ref.	€/Stk./pcs.

264 Treppenkante 30 x 40 x 2 mm, Aluminium eloxiert, gebohrt

stair nosing 30 x 40 x 2 mm,
aluminium anodized, drilled



silberfarbig silver	1,0	46560-7	11,78	46564-5	12,80
	2,7	46562-1	31,78		
goldfarbig gold	1,0	46570-6	12,22	46574-4	13,24
	2,7	46572-0	33,02		
bronzef. hell bronze light	1,0	46580-5	14,22	46584-3	15,20
	2,7	46582-9	38,40		
bronzef. dunkel bronze dark	1,0	46590-4	14,22	46594-2	15,20
	2,7	46592-8	38,40		

46564-5	12,80
46566-9	34,80
46574-4	13,24
46576-8	36,00
46584-3	15,20
46586-7	41,40
46594-2	15,20
46596-6	41,40

386 Treppenkante 30 x 40 x 2,5 mm, Aluminium eloxiert, gebohrt

stair nosing 30 x 40 x 2,5 mm,
aluminium anodized, drilled



silberfarbig silver	1,0	66700-1	12,14	66724-7	13,06
	2,7	66702-5	32,66		
goldfarbig gold	1,0	66704-9	13,70	66728-5	14,66
	2,7	66706-3	33,84		
bronzef. hell bronze light	1,0	66708-7	14,58	66732-2	15,56
	2,7	66710-0	39,38		
bronzef. dunkel bronze dark	1,0	66712-4	14,58	66736-0	15,56
	2,7	66714-8	39,38		

66724-7	13,06
66726-1	35,66
66728-5	14,66
66730-8	36,84
66732-2	15,56
66734-6	42,32
66736-0	15,56
66738-4	42,32

134 Treppenkante 30 x 40 x 3 mm, Aluminium eloxiert, gebohrt

stair nosing 30 x 40 x 3 mm,
aluminium anodized, drilled



silberfarbig silver	1,0	41340-0	13,86	41341-7	14,82
	2,7	41350-9	37,24		
goldfarbig gold	1,0	41360-8	14,36	41361-5	15,42
	2,7	41370-7	38,78		
bronzef. hell bronze light	1,0	41380-6	15,68	41381-3	16,74
	2,7	41390-5	42,26		
bronzef. dunkel bronze dark	1,0	41400-1	15,68	41401-8	16,74
	2,7	41410-0	42,26		

41341-7	14,82
41351-6	40,04
41361-5	15,42
41371-4	41,60
41381-3	16,74
41391-2	45,04
41401-8	16,74
41411-7	45,04

135 Treppenkante 30 x 40 x 5 mm, Aluminium eloxiert, gebohrt

stair nosing 30 x 40 x 5 mm,
aluminium anodized, drilled



silberfarbig silver	1,0	41260-1	15,16	41261-8	16,18
	2,7	41270-0	41,00		
goldfarbig gold	1,0	41280-9	15,84	41281-6	16,82
	2,7	41290-8	42,72		
bronzef. hell bronze light	1,0	41300-4	17,26	41301-1	18,26
	2,7	41310-3	46,64		
bronzef. dunkel bronze dark	1,0	41320-2	17,26	41321-9	18,26
	2,7	41330-1	46,64		

41261-8	16,18
41271-7	44,02
41281-6	16,82
41291-5	45,72
41301-1	18,26
41311-0	49,66
41321-9	18,26
41331-8	49,66



Befestigungsschenkel ausklinken attachment flanges notched		Art./ref.	€/m
		22240-8	7,16
Befestigungsschenkel ausklinken und biegen attachment flanges notched and bent		auf Anfrage on request	

Art./ref.	€/m
22240-8	7,16
auf Anfrage on request	

1. WINKELPROFILE + TREPPENKANTEN AUS ALUMINIUM + MESSING / 1. ANGLE EDGES + STAIR NOSINGS ALU + BRASS

Andere Eloxfarben siehe
 Abschnitt 6, Lieferzeit 14 Tage/
 other anodized colours see
 section 6, delivery time 14 days

Profi-Pack à 10 Stück im Bund			
professional packing à 10 pcs.			
Farbe/colour	L / l (m)	Art./ref.	€/Stk./pcs.

SB-Pack incl. Schr./ Dübel; VE 20 Stk.	
self-service-pack with screws/ dowels; à 20 pcs.	
Art./ref.	€/Stk./pcs.

519 Eckprofil 30 x 40 x 2 mm glatt, Aluminium eloxiert, gebohrt

corner profile 30 x 40 x 2 mm
 smooth, aluminium anodized,
 drilled



silberfarbig silver	1,0	71880-2	11,78
	2,7	71882-6	31,78
edelstahlfarbig stainless steel coloured	1,0	72696-8	14,08
	2,7	72698-2	38,04
schwarz black	1,0	72700-2	14,08
	2,7	72702-6	38,04

71884-0	12,80
71886-4	34,80
72706-4	15,08
72708-8	41,04
72710-1	15,08
72712-5	41,04

520 Eckprofil 30 x 40 x 2,5 mm glatt, Aluminium eloxiert, gebohrt

corner profile 30 x 40 x 2,5 mm
 smooth, aluminium anodized,
 drilled



silberfarbig silver	1,0	71890-1	12,14
	2,7	71892-5	32,66
edelstahlfarbig stainless steel coloured	1,0	72714-9	14,46
	2,7	72716-3	39,06
schwarz black	1,0	72718-7	14,46
	2,7	72720-0	39,06

71894-9	13,06
71896-3	35,66
72722-4	15,46
72724-8	42,06
72726-2	15,46
72728-6	42,06

521 Eckprofil 30 x 40 x 3 mm glatt, Aluminium eloxiert, gebohrt

corner profile 30 x 40 x 3 mm
 smooth, aluminium anodized,
 drilled



silberfarbig silver	1,0	71900-7	13,86
	2,7	71902-1	37,24
edelstahlfarbig stainless steel coloured	1,0	72730-9	16,24
	2,7	72732-3	43,86
schwarz black	1,0	72734-7	16,24
	2,7	72736-1	43,86

71904-5	14,82
71906-9	40,04
72738-5	17,24
72740-8	46,86
72742-2	17,24
72744-6	46,86

522 Eckprofil 30 x 40 x 5 mm glatt, Aluminium eloxiert, gebohrt

corner profile 30 x 40 x 5 mm
 smooth, aluminium anodized,
 drilled



silberfarbig silver	1,0	71910-6	15,16
	2,7	71912-0	41,00
edelstahlfarbig stainless steel coloured	1,0	72746-0	17,84
	2,7	72748-4	48,16
schwarz black	1,0	72750-7	17,84
	2,7	72752-1	48,16

71914-4	16,18
71916-8	44,02
72754-5	18,86
72756-9	51,18
72758-3	18,86
72760-6	51,18



Befestigungsschenkel ausklinken attachment flanges notched
Befestigungsschenkel ausklinken und biegen attachment flanges notched and bent

Art./ref.	€/m
22240-8	7,16
auf Anfrage on request	

2. TREPPENKANTEN EDELSTAHL

2. STAIR NOSINGS STAINLESS STEEL

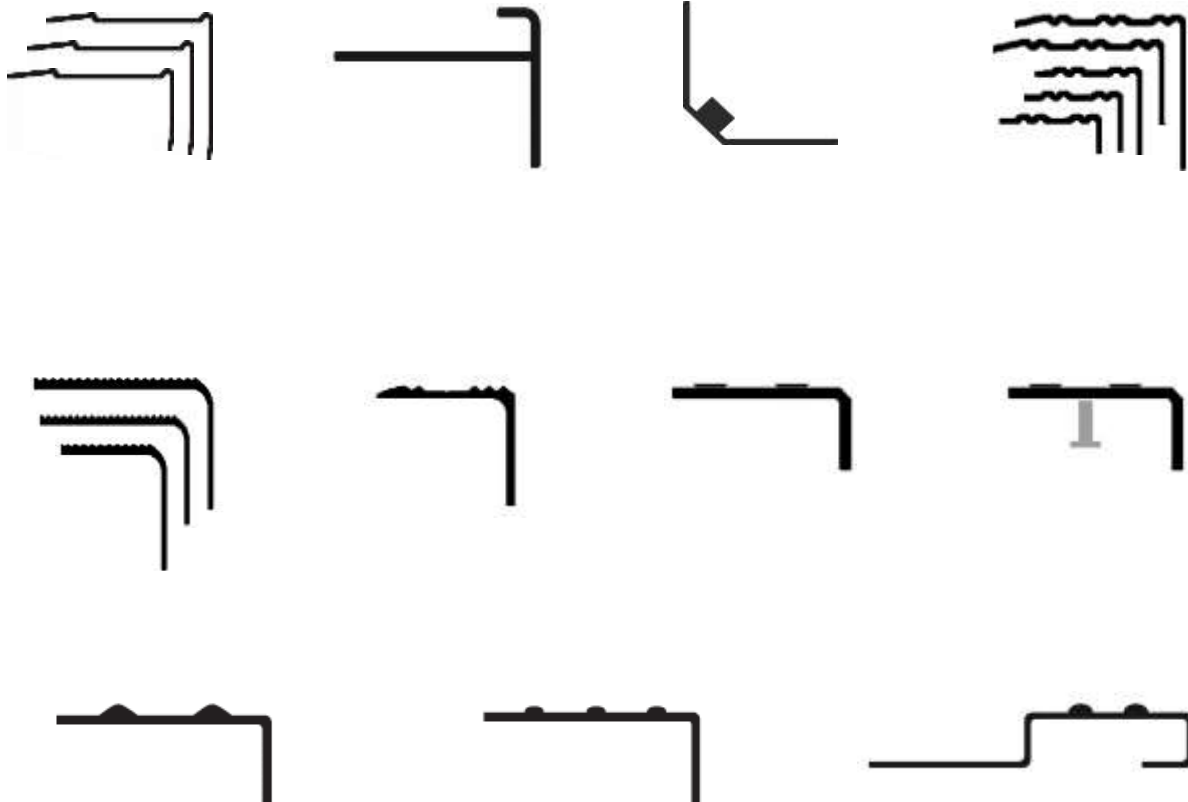

2. TREPPENKANTEN EDELSTAHL/ 2. STAIR NOSINGS STAINLESS STEEL

Edelstahlschrauben siehe
Abschnitt 12/ stainless steel
screws see section 12

394 Treppenkanten 25 x 63 x 1,5 mm INOX PROTECT, Edelstahl matt, gebohrt

stair nosing 25 x 63 x 1,5 mm
INOX PROTECT, stainless steel
matt, drilled

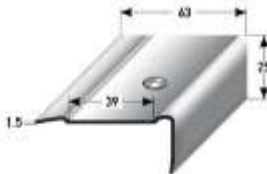

Edelstahl-Treppenkanten INOX PROTECT zur Verlegung mit Einlage 39 mm

stainless steel stair nosings for installation with insert 39 mm

L / l (m)	VE/unit	Art./ref.	€/Stk./pcs.
1,0 m	5 Stück/pcs.	67000-1	51,56
2,5 m		67002-5	128,88
3,0 m		67004-9	154,62

für Verlegung mit **Einlage 39 mm**, siehe Seite 23
for installation with insert 39 mm, see page 23

395 Treppenkanten 35 x 63 x 1,5 mm INOX PROTECT, Edelstahl matt, gebohrt

stair nosing 35 x 63 x 1,5 mm
INOX PROTECT, stainless steel
matt, drilled

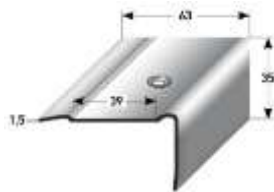

1,0 m	5 Stück/pcs.	67008-7	57,24
2,5 m		67010-0	143,18
3,0 m		67012-4	171,82

für Verlegung mit **Einlage 39 mm**, siehe Seite 23
for installation with insert 39 mm, see page 23

396 Treppenkanten 45 x 63 x 1,5 mm INOX PROTECT, Edelstahl matt, gebohrt

stair nosing 45 x 63 x 1,5 mm
INOX PROTECT, stainless steel
matt, drilled

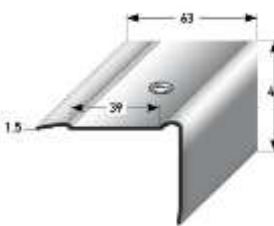

1,0 m	5 Stück/pcs.	67016-2	62,98
2,5 m		67018-6	157,50
3,0 m		67020-9	188,98

für Verlegung mit **Einlage 39 mm**, siehe Seite 23
for installation with insert 39 mm, see page 23

Treppenkante INOX PROTECT
mit Einlage 39 mm, gelb-schwarz
(siehe oben bzw. Seite 23)
stair nosing INOX PROTECT
with insert 39 mm, yellow-black
(see above and at page 23)

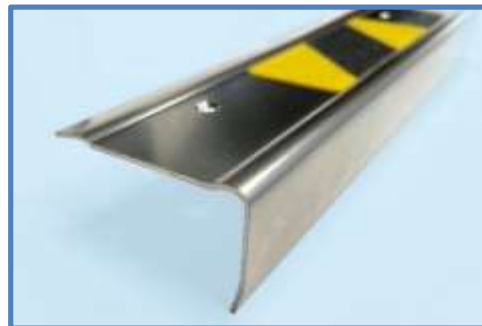

3,0 m-Ware ist nur per Spedition lieferbar (gesonderte Transportkosten)
3,0 m profiles are only available per forwarding agency (separate transport costs)

Trennscheibe 115 x 1 mm Inox special, zum Trennen von Edelstahlprofilen

cutting disc 115 x 1 mm Inox special,
suitable for cutting stainless steel
profiles



VE/unit	Art./ref.	€/Stk./pcs.
1 Stück/pcs.	22246-0	5,64

kaum Gratbildung bzw. thermische Blaufärbung
hardly any flashing and no discolouring

Fächerscheibe 115 x 22,2 mm, Körnung 80, zum Entgraten von Edelstahl

flap disc 115 x 22,2 mm, grain
size 80, suitable for deburring
stainless steel



1 Stück/pcs.	22250-7	9,20
--------------	---------	------

2. TREPPENKANTEN EDELSTAHL/ 2. STAIR NOSINGS STAINLESS STEEL

Andere Abmaße auf
 Anfrage/ other dimensions
 on demand

Edelstahl-Einschubprofile matt für Höhen von 2 mm bis 22 mm

insert profiles out of stainless steel mat for highs from 2 mm till 22 mm

Koffernr./ case no.	AxBxCxD (mm)	L / l (m)	VE/unit	Art./ref.	€/Stk./pcs.
------------------------	--------------	-----------	---------	-----------	-------------

Einschubprofil mit Nase, Edelstahl matt, gebohrt

nosed insert profile, stainless steel matt, drilled

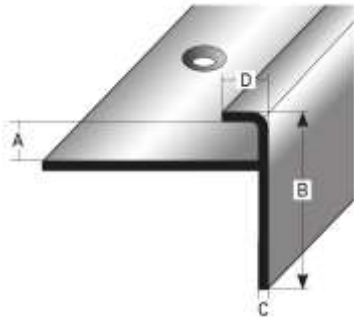

352	2 x 23 x 1,5 x 6	2,7 m	10 Stk./pcs.	60385-6	132,40
353	2,5 x 23 x 1,5 x 6			60395-5	
354	3 x 23 x 1,5 x 6			60405-1	
355	5 x 23 x 1,5 x 6			60416-7	
399	8 x 23 x 1,5 x 6			67662-1	
400	10 x 23 x 1,5 x 6			67668-3	
401	11 x 23 x 1,5 x 6			67674-4	
402	12 x 23 x 1,5 x 6			67680-5	
403	15 x 23 x 1,5 x 6			67686-7	

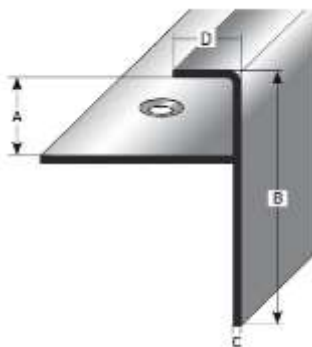

252	2,5 x 40 x 1,5 x 10	2,5 m	10 Stk./pcs.	60380-1	171,76
229	4,5 x 40 x 1,5 x 10			60390-0	
228	8 x 40 x 1,5 x 10			60400-6	
404	11 x 40 x 1,5 x 10			60402-0	
405	12 x 40 x 1,5 x 10			60408-2	
253	15 x 40 x 1,5 x 10			60410-5	
254	22 x 40 x 1,5 x 10			60420-4	

passende Edelstahlschrauben siehe Abschnitt 12/ suitable stainless steel screws see section 12

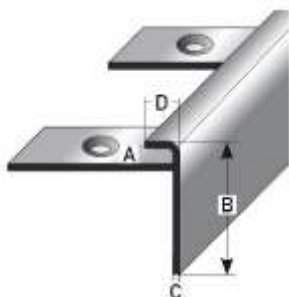

Profil biegen
 profile bent

auf Anfrage
 on request

Die Fertigung erfolgt auf Fixlängen, Verschnitt wird mit berechnet, ohne Zuschneidkosten.
 Production takes place on fixed lengths, blended is charged with, without calculation of the cost of cutting.

2. TREPPENKANTEN EDELSTAHL/ 2. STAIR NOSINGS STAINLESS STEEL

Andere Abmaße auf Anfrage/ other dimensions on demand

Edelstahl-Treppennenecken matt gebürstet für Höhen von 2 mm bis 22 mm

stair inside corner out of stainless steel matt for heights from 2 mm till 22 mm

Koffernr./ case no.	Für Belaghöhe = h in mm/ for flooring height = h in mm	L / l (m)	VE/unit	Art./ref.	€/Stk./pcs.
---------------------	--	-----------	---------	-----------	-------------

Treppennenecke Edelstahl matt, gebohrt

stair inside corner, stainless steel matt, drilled

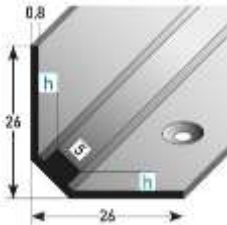

367	2 - 3 mm	1,0 m	10 Stk./pcs.	45621-6	43,54
		2,7 m		45620-9	117,58

368	3 - 5 mm	1,0 m	10 Stk./pcs.	45616-2	46,14
		2,7 m		45615-5	124,54

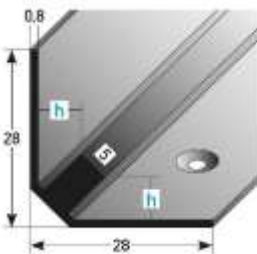

406	8 mm	1,0 m	10 Stk./pcs.	67612-6	59,40
		2,7 m		67614-0	160,42

407	10 mm	1,0 m	10 Stk./pcs.	67620-1	59,40
		2,7 m		67622-5	160,42

408	11 mm	1,0 m	10 Stk./pcs.	67628-7	62,66
		2,7 m		67630-0	169,14

409	12 mm	1,0 m	10 Stk./pcs.	67636-2	62,66
		2,7 m		67638-6	169,14

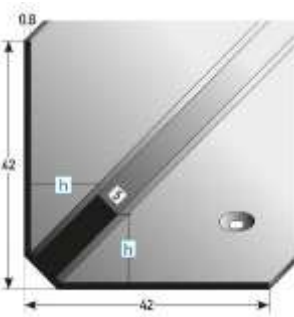

410	15 mm	1,0 m	10 Stk./pcs.	67644-7	69,62
		2,7 m		67646-1	187,98

411	22 mm	1,0 m	10 Stk./pcs.	67652-2	72,24
		2,7 m		67654-6	195,08

Die Fertigung erfolgt auf Fixlängen, Verschnitt wird mit berechnet, ohne Zuschneidkosten. Production takes place on fixed lengths, blended is charged with, without calculation of the cost of cutting.

passende Edelstahlschrauben siehe Abschnitt 12

suitable stainless steel screws see section 12

Beispiel: Edelstahl-Einschubprofil mit Nase und Edelstahl-Treppennenecke (siehe oben und vorherige Seite)

example: stainless steel insert profile with nose and stainless steel stair inside corner (see above and previous page)



2. TREPPENKANTEN EDELSTAHL/ 2. STAIR NOSINGS STAINLESS STEEL

Rutschhemmungsklasse: R10 Prüfzeugnis kann angefordert werden.

slip resistance class: R10 certificate can be requested.

Edelstahl-Treppenkante mit **profiliertes Riffelung**, matt, 1,5 mm Materialdicke

stair nosing out of stainless steel matt, with fluted ruffle, 1,5 mm material thickness

passende Edelstahlschrauben
 siehe Abschnitt 12/ suitable
 stainless steel screws see section 12

Profi-Pack à 10 Stück im Bund

professional packing à 10 pcs.

L / l (m)	VE/unit	Art./ref.	€/Stk./pcs.
-----------	---------	-----------	-------------

SB incl. Dübel/ Edelstahlschrauben

self-service-pack with dowels/
stainless steel screws

Art./ref.	€/Stk./pcs.
-----------	-------------

154 Edelstahl-Treppenkante 20 x 40 x 1,5 mm, profilierte Riffelung, matt, gebohrt

stainless steel stair nosing 20 x 40 x 1,5 mm, fluted profile, matt, drilled



1,0	10	61630-6	44,58
2,7	Stk./pcs.	61640-5	120,50

61635-1	47,24
61645-0	128,38

R10

201 Edelstahl-Treppenkante 40 x 40 x 1,5 mm, profilierte Riffelung, matt, gebohrt

stainless steel stair nosing 40 x 40 x 1,5 mm, fluted profile, matt, drilled



1,0	10	61690-0	59,50
2,7	Stk./pcs.	61700-6	160,62

61695-5	62,14
61705-1	168,52

R10

202 Edelstahl-Treppenkante 30 x 30 x 1,5 mm, profilierte Riffelung, matt, gebohrt

stainless steel stair nosing 30 x 30 x 1,5 mm, fluted profile, matt, drilled

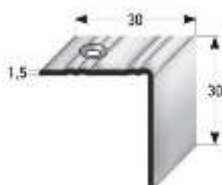

1,0	10	61720-4	44,58
2,7	Stk./pcs.	61730-3	120,50

61725-9	47,24
61735-8	128,38

R10

203 Edelstahl-Treppenkante 20 x 30 x 1,5 mm, profilierte Riffelung, matt, gebohrt

stainless steel stair nosing 20 x 30 x 1,5 mm, fluted profile, matt, drilled

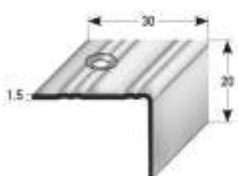

1,0	10	61750-1	37,18
2,7	Stk./pcs.	61760-0	100,38

61755-6	39,80
61765-5	108,30

R10

204 Edelstahl-Treppenkante 10 x 30 x 1,5 mm, profilierte Riffelung, matt, gebohrt

stainless steel stair nosing 10 x 30 x 1,5 mm, fluted profile, matt, drilled

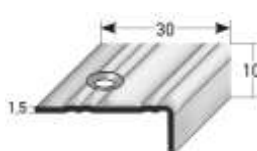

1,0	10	61780-8	29,76
2,7	Stk./pcs.	61790-7	80,32

61785-3	32,38
61795-2	88,16

R10

- ungebohrte Profile & Längen bis 6,0 m auf Anfrage/ undrilled profiles and lengths up to 6,0 m on request

- Werkstoff 1.4301 (V2A) / V4A auf Anfrage/ material 1.4301 (V2A) / V4A on request

- Qualität zu wählen ist die beste Art zu sparen -

choosing quality is the best way to save

2. TREPPENKANTEN EDELSTAHL/ 2. STAIR NOSINGS STAINLESS STEEL

Rutschhemmungsklasse: R10 Prüfzeugnis kann angefordert werden.

slip resistance class: R10 certificate can be requested.

Edelstahl-Treppenkante mit gefräster Riffelung - Zum Gegenstoßen von Bodenbelägen oder Beschichtungen bis 3mm, rutschhemmende Riffelung, Glatfläche matt, gekantet, gebohrt mit Senkung

stainless steel stair nosing with milled fluting - for installation with carpets up to 3mm, antislip fluting, smooth edge matt, edged, countersunk drilled

L / l (m)	VE/unit	Art./ref.	€/Stk./pcs.
-----------	---------	-----------	-------------

206 Edelstahl-Treppenkante 20 x 40 x 3 mm, gefräste Riffelung, gekantet, gebohrt

stainless steel stair nosing 20 x 40 x 3 mm, milled fluting, edged, drilled

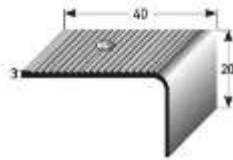

1,0	1 Stk./pcs.	60500-3	181,52
2,5		60501-0	453,84

R10

passende Edelstahlschrauben siehe Abschnitt 12
suitable stainless steel screws see section 12

207 Edelstahl-Treppenkante 30 x 30 x 3 mm, gefräste Riffelung, gekantet, gebohrt

stainless steel stair nosing 30 x 30 x 3 mm, milled fluting, edged, drilled

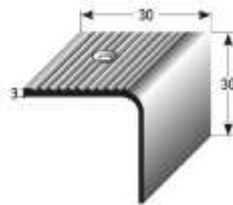

1,0	1 Stk./pcs.	60510-2	181,52
2,5		60511-9	453,84

R10

passende Edelstahlschrauben siehe Abschnitt 12
suitable stainless steel screws see section 12

208 Edelstahl-Treppenkante 28 x 50 x 3 mm, gefräste Riffelung, gekantet, gebohrt

stainless steel stair nosing 28 x 50 x 3 mm, milled fluting, edged, drilled



1,0	1 Stk./pcs.	60520-1	242,02
2,5		60521-8	605,12

R10

passende Edelstahlschrauben siehe Abschnitt 12
suitable stainless steel screws see section 12



Kante im Auslauf anphasen (zum Aufsetzen auf Bodenbelag)
chamfering edges (to be installed on top of flooring)

22213-2	42,66/m
---------	---------

Treppenkante Edelstahl V4A gezogen

drawn stainless steel stair nosing V4A

Profi-Pack à 10 Stück im Bund

professional packing à 10 pcs.

L / l (m)	VE/unit	Art./ref.	€/Stk./pcs.
-----------	---------	-----------	-------------

SB incl. Dübel/Edelstahlschrauben

self-service-pack with dowels/
stainless steel screws

Art./ref.	€/Stk./pcs.
-----------	-------------

438 Treppenkante 23 x 25 x 3,5 mm, Edelstahl V4A gezogen, gebohrt

drawn stainless steel stair nosing V4A 23 x 25 x 3,5 mm, drilled



1,0	10 Stk./pcs.	68250-9	127,74	68256-1	130,38
2,5		68252-3	319,30		

2. TREPPENKANTEN EDELSTAHL/ 2. STAIR NOSINGS STAINLESS STEEL

Rutschhemmungsklasse: R12 Prüfzeugnis kann angefordert werden.

slip resistance class: R12 certificate can be requested.

3,5 mm-Edelstahlschrauben,
siehe Abschnitt 12
3,5 mm stainless steel screws,
see section 12

Edelstahl-Treppenkanten mit Prägelochung , matt, gebohrt, mit Schutzfolie, VE 1 Stück			
stainless steel stair nosings with embossed punching, 1,5 mm material thickness, matt, drilled, unit 1 pcs.			
Dimension (mm)	L / l (m)	Art./ref.	€/Stk./pcs.
10 x 30 x 1,5	1,0 m	65118-5	33,74
	2,5 m	65120-8	84,40
	3,0 m*	65122-2	101,24
R12			
20 x 40 x 1,5	1,0 m	65128-4	55,44
	2,5 m	65130-7	138,62
	3,0 m*	65132-1	166,34
R12			
25 x 60 x 1,5	1,0 m	65158-1	83,16
	2,5 m	65160-4	207,96
	3,0 m*	65162-8	249,54
R12			
25 x 80 x 1,5	1,0 m	65168-0	110,94
	2,5 m	65170-3	277,28
	3,0 m*	65172-7	332,76
R12			
50 x 80 x 1,5	1,0 m	65178-9	137,36
	2,5 m	65180-2	343,32
	3,0 m*	65182-6	411,98
R12			

311 Treppenkante 10 x 30 x 1,5 mm mit Prägelochung, Edelstahl matt, gebohrt, mit Schutzfolie

stair nosing 10 x 30 x 1,5 mm with embossed punching, stainless steel matt, drilled, with protective film



312 Treppenkante 20 x 40 x 1,5 mm mit Prägelochung, Edelstahl matt, gebohrt, mit Schutzfolie

stair nosing 20 x 40 x 1,5 mm with embossed punching, stainless steel matt, drilled, with protective film



318 Treppenkante 25 x 60 x 1,5 mm mit Prägelochung, Edelstahl matt, gebohrt, mit Schutzfolie

stair nosing 25 x 60 x 1,5 mm with embossed punching, stainless steel matt, drilled, with protective film

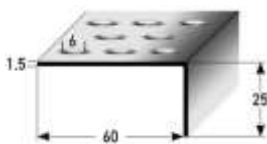

319 Treppenkante 25 x 80 x 1,5 mm mit Prägelochung, Edelstahl matt, gebohrt, mit Schutzfolie

stair nosing 25 x 80 x 1,5 mm with embossed punching, stainless steel matt, drilled, with protective film



320 Treppenkante 50 x 80 x 1,5 mm mit Prägelochung, Edelstahl matt, gebohrt, mit Schutzfolie

stair nosing 50 x 80 x 1,5 mm with embossed punching, stainless steel matt, drilled, with protective film

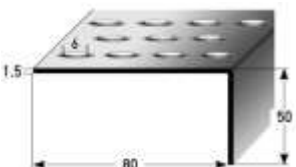

* 3,0 m-Ware ist nur per Spedition lieferbar (gesonderte Transportkosten)

3,0 m profiles are only available per forwarding agency (separate transport costs)

Lieferzeit nach vorheriger Absprache
delivery time by prior arrangement

2. TREPPENKANTEN EDELSTAHL/ 2. STAIR NOSINGS STAINLESS STEEL

Rutschhemmungsklasse: R12 Prüfzeugnis kann angefordert werden.

slip resistance class: R12 certificate can be requested.

Edelstahl-Treppenkanten mit Prägelochung und ANKERBOLZEN, matt, mit Schutzfolie, VE 1 Stück, zum Einbetten in Beton

stainless steel stair nosings with embossed punching and anchor bolt, matt, unit 1 pcs., for embedding in concrete

Dimension (mm)	L / l (m)	Art./ref.	€/Stk./pcs.
----------------	-----------	-----------	-------------

328 Treppenkante 10 x 30 x 1,5 mm mit Prägelochung + Ankerbolzen, Edelstahl matt

stair nosing 10 x 30 x 1,5 mm with embossed punching + anchor bolt, stainless steel matt



10 x 30 x 1,5	1,0 m	65188-8	53,00
	2,5 m	65190-1	132,54
	3,0 m*	65192-5	159,02

R12

5 Ankerbolzen/ Laufmeter à ø 6 mm und 20 mm Länge

5 anchor bolt/ running meter à ø 6 mm and 20 mm length

329 Treppenkante 20 x 40 x 1,5 mm mit Prägelochung + Ankerbolzen, Edelstahl matt

stair nosing 20 x 40 x 1,5 mm with embossed punching + anchor bolt, stainless steel matt



20 x 40 x 1,5	1,0 m	65198-7	74,72
	2,5 m	65200-7	186,76
	3,0 m*	65202-1	224,10

R12

5 Ankerbolzen/ Laufmeter à ø 6 mm und 20 mm Länge

5 anchor bolt/ running meter à ø 6 mm and 20 mm length

330 Treppenkante 25 x 60 x 1,5 mm mit Prägelochung + Ankerbolzen, Edelstahl matt

stair nosing 25 x 60 x 1,5 mm with embossed punching + anchor bolt, stainless steel matt



25 x 60 x 1,5	1,0 m	65208-3	102,40
	2,5 m	65210-6	256,08
	3,0 m*	65212-0	307,28

R12

5 Ankerbolzen/ Laufmeter à ø 6 mm und 30 mm Länge

5 anchor bolt/ running meter à ø 6 mm and 30 mm length

331 Treppenkante 25 x 80 x 1,5 mm mit Prägelochung + Ankerbolzen, Edelstahl matt

stair nosing 25 x 80 x 1,5 mm with embossed punching + anchor bolt, stainless steel matt



25 x 80 x 1,5	1,0 m	65238-0	130,18
	2,5 m	65240-3	325,48
	3,0 m*	65242-7	390,54

R12

5 Ankerbolzen/ Laufmeter à ø 6 mm und 30 mm Länge

5 anchor bolt/ running meter à ø 6 mm and 30 mm length

332 Treppenkante 50 x 80 x 1,5 mm mit Prägelochung + Ankerbolzen, Edelstahl matt

stair nosing 50 x 80 x 1,5 mm with embossed punching + anchor bolt, stainless steel matt



50 x 80 x 1,5	1,0 m	65248-9	156,58
	2,5 m	65250-2	391,46
	3,0 m*	65252-6	469,76

R12

5 Ankerbolzen/ Laufmeter à ø 6 mm und 30 mm Länge

5 anchor bolt/ running meter à ø 6 mm and 30 mm length

*** 3,0 m-Ware ist nur per Spedition lieferbar (gesonderte Transportkosten)**

3,0 m profiles are only available per forwarding agency (separate transport costs)

Lieferzeit nach vorheriger Absprache/ delivery time by prior arrangement

2. TREPPENKANTEN EDELSTAHL/ 2. STAIR NOSINGS STAINLESS STEEL

Fertigung auf Fixlängen auf Anfrage möglich/ production of end length possible on request

Edelstahl-Treppenkanten Noppenprägung, matt, mit Schutzfolie, VE 1 Stück

stainless steel stair nosings with nub embossing, matt, unit 1 pcs.

Noppenaußenmaß nub outside dimension	L / l (m)	Art./ref.	€/Stk./pcs.
---	-----------	-----------	-------------

507 Treppenkante 20 x 40 x 1,5 mm mit 5 mm-Noppenprägung, Edelstahl matt, gebohrt

stair nosing 20 x 40 x 1,5 mm with 5 mm nub embossing, stainless steel matt, drilled

5 mm	1,0 m	71632-7	55,44
	2,5 m	71634-1	138,62

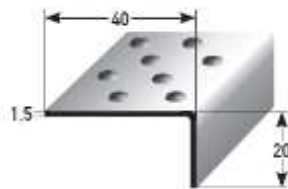

508 Treppenkante 25 x 60 x 1,5 mm mit 5 mm-Noppenprägung, Edelstahl matt, gebohrt

stair nosing 25 x 60 x 1,5 mm with 5 mm nub embossing, stainless steel matt, drilled

5 mm	1,0 m	71636-5	83,16
	2,5 m	71638-9	207,96

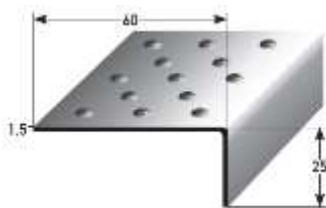

509 Treppenkante 20 x 40 x 1,5 mm mit 8 mm-Noppenprägung, Edelstahl matt, gebohrt

stair nosing 20 x 40 x 1,5 mm with 8 mm nub embossing, stainless steel matt, drilled

8 mm	1,0 m	71640-2	55,44
	2,5 m	71642-6	138,62

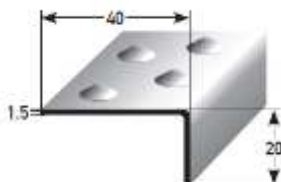

510 Treppenkante 25 x 60 x 1,5 mm mit 8 mm-Noppenprägung, Edelstahl matt, gebohrt

stair nosing 25 x 60 x 1,5 mm with 8 mm nub embossing, stainless steel matt, drilled

8 mm	1,0 m	71644-0	83,16
	2,5 m	71646-4	207,96

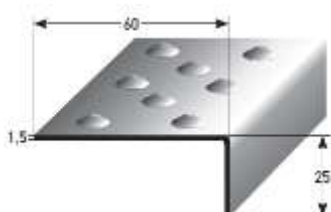

Befestigung mit Ankerbolzen auf Anfrage erhältlich
 fixing with anchor bolt available on request

2. TREPPENKANTEN EDELSTAHL/ 2. STAIR NOSINGS STAINLESS STEEL

Fliesen-Treppenkante mit Noppenprägung, Edelstahl matt, mit Schutzfolie, VE 1 Stück

tile stair nosing with nub embossing, stainless steel matt, with protective film, 1 piece

Belaghöhe Innenmaß (h) flooring height inside dimension (h)	L / l (m)	Art./ref.	€/Stk./pcs.
---	-----------	-----------	-------------

523 Fliesen-Treppenkante 25 x 1,0 mm mit 5 mm-Noppenprägung, Edelstahl matt,

mit Dreieckstanzung

tile stair nosing 25 x 1,0 mm
with 5 mm knob embossing,
stainless steel matt, with
triangular punching

6 mm	2,5 m	71920-5	56,82
8 mm		71922-9	58,84

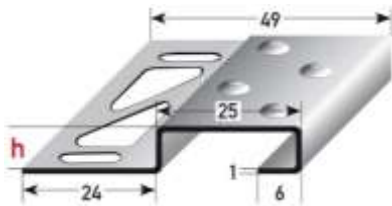

Seitliche Abdeckkappen und andere Höhen auf Anfrage erhältlich!

Lateral cover caps and other heights available on request!



3. WAND-, KANTENSCHUTZ- & SPEZIALPROFILE AUS EDELSTAHL, ALUMINIUM UND MESSING

3. WALL + CORNER PROTECTION + SPECIAL PROFILES
OUT OF STAINLESS STEEL + ALUMINIUM + BRASS

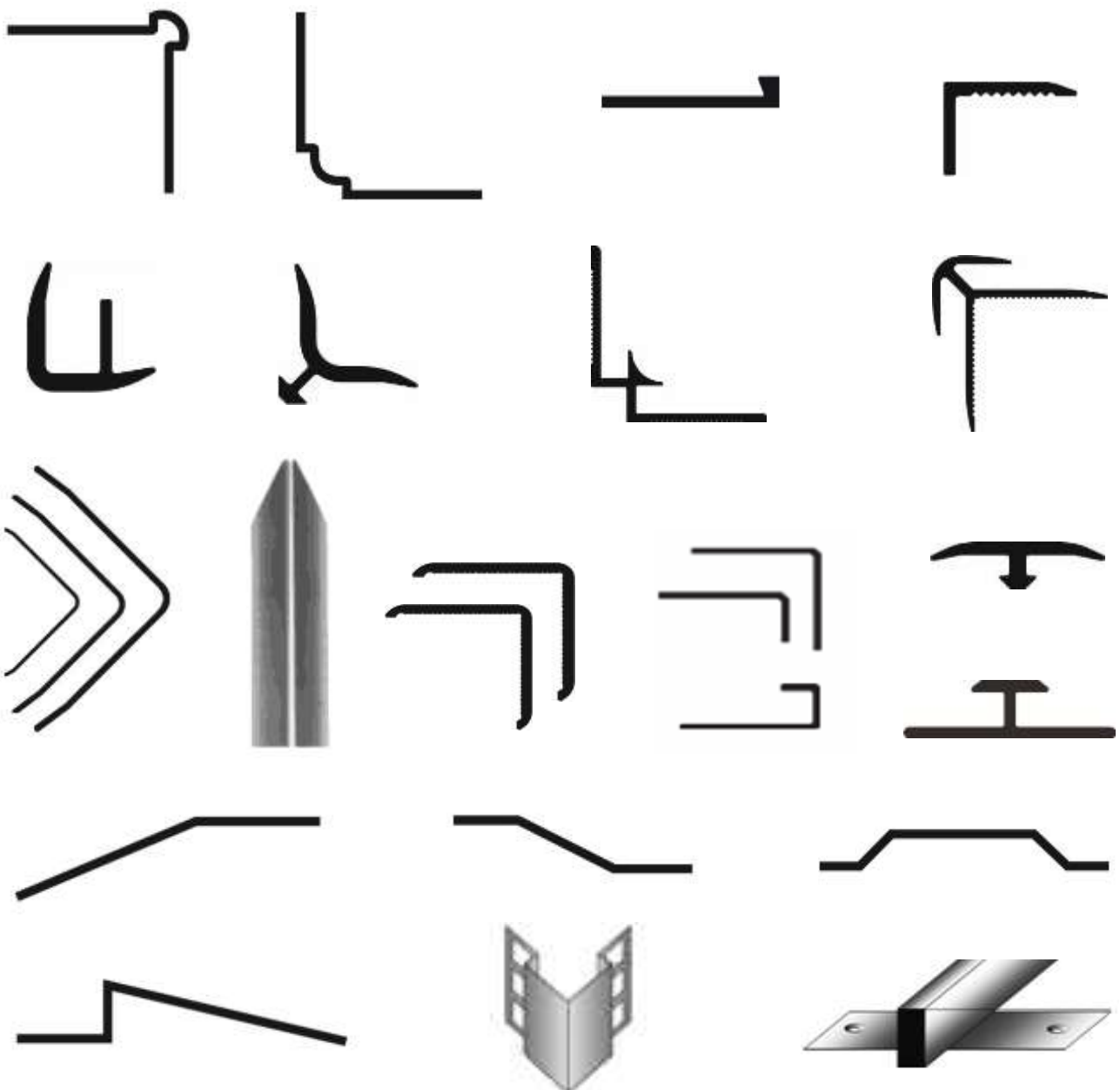

3. WAND-, KANTENSCHUTZ- & SPEZIALPROFILE/ 3. WALL+CORNER PROTECTION+SPECIAL PROFILES

Andere Eloxalfarben siehe Abschnitt 6, Lieferzeit 14 Tage/ Lieferzeit f. Pulverbeschichtet auf Anfrage / other anodized colours see section 6, delivery time 14 days/ delivery time for powder coating on request

Wand- und Anstoßprofile aus Aluminium			
wall profiles and edge profile out of aluminium			
Farbe/colour	L / l (m)	Art./ref.	€/Stk./pcs.

493 Wandprofil Außenecke 2 mm, Aluminium, ungebohrt

wall profile outside corner 2 mm, aluminium, undrilled

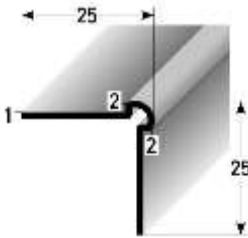

silberfarbig silver	2,7	71248-0	18,10
edelstahlfarbig stainless steel coloured		71250-3	23,74
Pulverbeschichtet nach RAL9016 Verkehrsweiß powder RAL9016		71252-7	26,86
Pulverbeschichtet nach RAL; Preis ab 150 lfm. powder RAL; price from 150 m	2,7	71254-1	29,20
	Pulvern nach RAL unter 150 lfm. auf Anfrage powdered (RAL) less than 150 m on request		

493 Wandprofil Außenecke 2 mm, Aluminium, mit Dreieckstanzung

wall profile outside corner 2 mm, aluminium, triangle punching

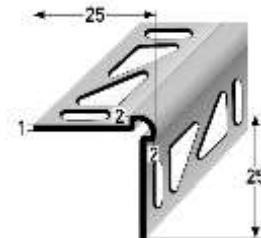

silberfarbig silver	2,7	71650-1	20,60
edelstahlfarbig stainless steel coloured		71652-5	29,20
Pulverbeschichtet nach RAL9016 Verkehrsweiß powder RAL9016		71654-9	29,40
Pulverbeschichtet nach RAL; Preis ab 150 lfm. powder RAL; price from 150 m	2,7	71656-3	31,74
	Pulvern nach RAL unter 150 lfm. auf Anfrage powdered (RAL) less than 150 m on request		

511 Wandprofil Außenecke 3 mm, Aluminium, ungebohrt

wall profile outside corner 3 mm, aluminium, undrilled

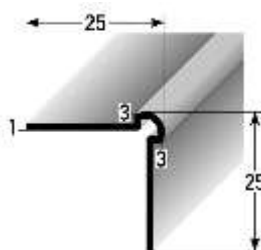

silberfarbig silver	2,7	71660-0	18,14
edelstahlfarbig stainless steel coloured		71662-4	26,72
Pulverbeschichtet nach RAL9016 Verkehrsweiß powder RAL9016		71664-8	26,90
Pulverbeschichtet nach RAL; Preis ab 150 lfm. powder RAL; price from 150 m	2,7	71666-2	29,22
	Pulvern nach RAL unter 150 lfm. auf Anfrage powdered (RAL) less than 150 m on request		

511 Wandprofil Außenecke 3 mm, Aluminium, mit Dreieckstanzung

wall profile outside corner 3 mm, aluminium, triangle punching

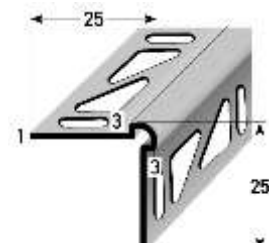

silberfarbig silver	2,7	71670-9	21,76
edelstahlfarbig stainless steel coloured		71672-3	30,36
Pulverbeschichtet nach RAL9016 Verkehrsweiß powder RAL9016		71674-7	30,52
Pulverbeschichtet nach RAL; Preis ab 150 lfm. powder RAL; price from 150 m	2,7	71676-1	32,86
	Pulvern nach RAL unter 150 lfm. auf Anfrage powdered (RAL) less than 150 m on request		

3. WAND-, KANTENSCHUTZ- & SPEZIALPROFILE/ 3. WALL+CORNER PROTECTION+SPECIAL PROFILES

Andere Eloxalfarben siehe Abschnitt 6, Lieferzeit 14 Tage/ Lieferzeit f. Pulverbeschichtet auf Anfrage / other anodized colours see section 6, delivery time 14 days/ delivery time for powder coating on request

Wand- und Anstoßprofile aus Aluminium			
wall profiles and edge profile out of aluminium			
Farbe/colour	L / l (m)	Art./ref.	€/Stk./pcs.

494 Wandprofil Innenecke 2 mm, Aluminium, ungebohrt

wall profile inside corner
2 mm, aluminium, undrilled

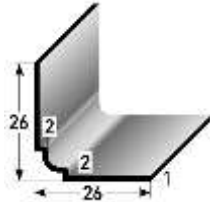

silberfarbig silver	2,7	71268-8	19,16
edelstahlfarbig stainless steel coloured		71270-1	23,14
Pulverbeschichtet nach RAL9016 Verkehrsweiß / powder RAL9016		71272-5	26,54
Pulverbeschichtet nach RAL; Preis ab 150 lfm. powder RAL; price from 150 m	2,7	71274-9	28,92
Pulvern nach RAL unter 150 lfm. auf Anfrage powdered (RAL) less than 150 m on request			

494 Wandprofil Innenecke 2 mm, Aluminium, mit Dreieckstanzung

wall profile inside corner 2 mm,
aluminium, triangle punching

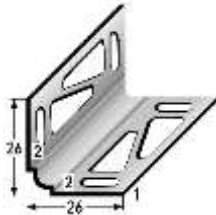

silberfarbig silver	2,7	71680-8	21,70
edelstahlfarbig stainless steel coloured		71682-2	28,52
Pulverbeschichtet nach RAL9016 Verkehrsweiß / powder RAL9016		71684-6	29,04
Pulverbeschichtet nach RAL; Preis ab 150 lfm. powder RAL; price from 150 m	2,7	71686-0	31,40
Pulvern nach RAL unter 150 lfm. auf Anfrage powdered (RAL) less than 150 m on request			

512 Wandprofil Innenecke 3 mm, Aluminium, ungebohrt

wall profile inside corner
3 mm, aluminium, undrilled

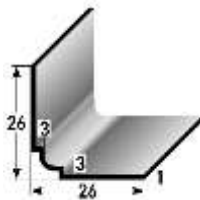

silberfarbig silver	2,7	71690-7	19,18
edelstahlfarbig stainless steel coloured		71692-1	26,36
Pulverbeschichtet nach RAL9016 Verkehrsweiß / powder RAL9016		71694-5	26,56
Pulverbeschichtet nach RAL; Preis ab 150 lfm. powder RAL; price from 150 m	2,7	71696-9	28,94
Pulvern nach RAL unter 150 lfm. auf Anfrage powdered (RAL) less than 150 m on request			

512 Wandprofil Innenecke 3 mm, Aluminium, mit Dreieckstanzung

wall profile inside corner 3 mm,
aluminium, triangle punching



silberfarbig silver	2,7	71700-3	22,82
edelstahlfarbig stainless steel coloured		71702-7	29,96
Pulverbeschichtet nach RAL9016 Verkehrsweiß / powder RAL9016		71704-1	30,18
Pulverbeschichtet nach RAL; Preis ab 150 lfm. powder RAL; price from 150 m	2,7	71706-5	32,56
Pulvern nach RAL unter 150 lfm. auf Anfrage powdered (RAL) less than 150 m on request			

495 Anstoßprofil 2 mm, Aluminium, ungebohrt

edge profile 2 mm, aluminium
anodized, undrilled

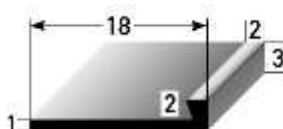

silberfarbig silver	2,7	71310-4	13,18
edelstahlfarbig stainless steel coloured		71312-8	16,32
Pulverbeschichtet nach RAL9016 Verkehrsweiß / powder RAL9016		71314-2	20,66
Pulverbeschichtet nach RAL; Preis ab 150 lfm. powder RAL; price from 150 m	2,7	71316-6	23,02
Pulvern nach RAL unter 150 lfm. auf Anfrage powdered (RAL) less than 150 m on request			

3. WAND-, KANTENSCHUTZ- & SPEZIALPROFILE/ 3. WALL+CORNER PROTECTION+SPECIAL PROFILES

Andere Eloxalfarben oder Pulverbeschichtet auf Anfrage / other anodized colours or powder coating on request

Wand- und Anstoßprofile aus Aluminium			
wall profiles and edge profile out of aluminium			
Farbe/colour	L / l (m)	Art./ref.	€/Stk./pcs.

575 Wand-Außenecke 3,5 x 3,5 mm, Aluminium, ungebohrt, SB-verpackt

wall outside corner 3,5 x 3,5 mm, aluminium, undrilled, self-service packaging

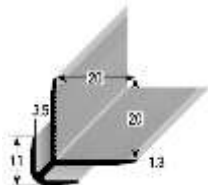

silberfarbig silver	2,7	72898-6	29,20
edelstahlfarbig stainless steel coloured		72900-6	37,30
schwarz black		72902-0	39,12

576 Wand-Außenecke 5 x 5 mm, Aluminium, ungebohrt, SB-verpackt

wall outside corner 5 x 5 mm, aluminium, undrilled, self-service packaging

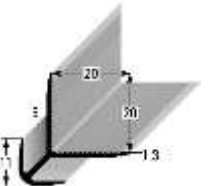

silberfarbig silver	2,7	72906-8	30,18
edelstahlfarbig stainless steel coloured		72908-2	38,50
schwarz black		72910-5	39,68

577 Wand-Innenecke 3,5 x 3,5 mm, Aluminium, ungebohrt, SB-verpackt

wall inside corner 3,5 x 3,5 mm, aluminium, undrilled, self-service packaging

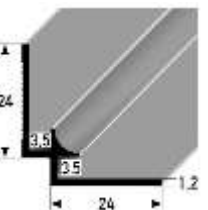

silberfarbig silver	2,7	72914-3	24,02
edelstahlfarbig stainless steel coloured		72916-7	30,46
schwarz black		72918-1	31,94

578 Wand-Innenecke 5 x 5 mm, Aluminium, ungebohrt, SB-verpackt

wall inside corner 5 x 5 mm, aluminium, undrilled, self-service packaging

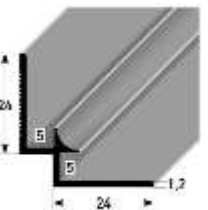

silberfarbig silver	2,7	72922-8	25,28
edelstahlfarbig stainless steel coloured		72924-2	32,08
schwarz black		72926-6	33,66

579 Doppeleinschub 3,5 x 3,5 mm, Aluminium, ungebohrt, SB-verpackt

double insert profile 3,5 x 3,5 mm, aluminium, undrilled, self-service packaging

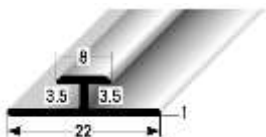

silberfarbig silver	2,7	72930-3	19,90
edelstahlfarbig stainless steel coloured		72932-7	26,08
schwarz black		72934-1	27,04



Befestigungsschenkel ausklinken attachment flanges notched	Art./ref.	€/m
	22240-8	7,16
Befestigungsschenkel ausklinken und biegen attachment flanges notched and bent	auf Anfrage on request	

3. WAND-, KANTENSCHUTZ- & SPEZIALPROFILE/ 3. WALL+CORNER PROTECTION+SPECIAL PROFILES

Andere Eloxalfarben oder Pulverbeschichtet auf Anfrage / other anodized colours or powder coating on request

Wand- und Anstoßprofile aus Aluminium			
wall profiles and edge profile out of aluminium			
Farbe/colour	L / l (m)	Art./ref.	€/Stk./pcs.

580 Doppelseinschub 5 x 5 mm, Aluminium, ungebohrt, SB-verpackt

double insert profile 5 x 5 mm, aluminium, undrilled, self-service packaging

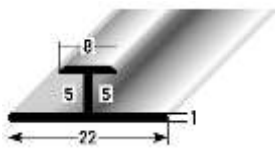

silberfarbig silver	2,7	72938-9	20,62
edelstahlfarbig stainless steel coloured		72940-2	27,06
schwarz black		72942-6	28,04



Befestigungsschenkel ausklinken attachment flanges notched	Art./ref.	€/m
	22240-8	7,16
Befestigungsschenkel ausklinken und biegen attachment flanges notched and bent	auf Anfrage on request	

MINI-Profil aus Aluminium

mini profiles out of aluminium

Farbe/colour	L / l (m)	Art./ref.	€/Stk./pcs.
--------------	-----------	-----------	-------------

581 Mini-Außenecke 10 x 10 mm, Aluminium, für Beläge bis 3,5 mm, ungebohrt, SB-verpackt

mini outside corner 10 x 10 mm, aluminium, for coverings up to 3,5 mm, undrilled, self-service packaging

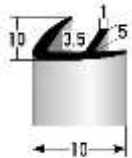

silberfarbig silver	2,7	72946-4	22,30
edelstahlfarbig stainless steel coloured		72948-8	28,56
schwarz black		72950-1	28,88

582 Mini-Innenecke 10 x 10 mm, Aluminium, für Beläge ab 1,3 mm, ungebohrt, SB-verpackt

mini inside corner 10 x 10 mm, aluminium, from coverings from 1,3 mm, undrilled, self-service packaging

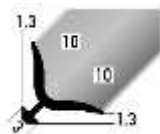

silberfarbig silver	2,7	72954-9	22,30
edelstahlfarbig stainless steel coloured		72956-3	28,56
schwarz black		72958-7	28,88

583 Mini-T-Profil 14 x 2,2 mm, Aluminium, ungebohrt, SB-verpackt

mini T-profile 14 x 2,2 mm, aluminium, undrilled, self-service packaging

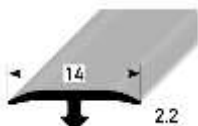

silberfarbig silver	2,7	72962-4	19,40
edelstahlfarbig stainless steel coloured		72964-8	25,62
schwarz black		72966-2	25,96

584 Mini-Winkel 7 x 10 mm, Aluminium, ungebohrt, SB-verpackt

mini angle profile 7 x 10 mm, aluminium, undrilled, self-service packaging

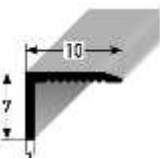

silberfarbig silver	2,7	72970-9	19,84
edelstahlfarbig stainless steel coloured		72972-3	26,32
schwarz black		72974-7	26,84



Profil biegen - auf Anfrage
bent profile - on request

3. WAND-, KANTENSCHUTZ- & SPEZIALPROFILE/ 3. WALL+CORNER PROTECTION+SPECIAL PROFILES

Andere Eloxalfarben siehe
Abschnitt 6, Lieferzeit 14 Tage/
other anodized colours see
section 6, delivery time 14 days
Schnittkanten pressblank/
cut edges press-finished

Eckschutzwinkel ohne Spitze aus Aluminium					
corner protection angles without tip out of Aluminium					
Farbe/colour	L / l (m)	selbstklebend self-adhesive	€/Stk./pcs.	ohne alles/ plain	€/Stk./pcs.

337 Eckschutzwinkel 20 x 20 x 1,8 mm, ohne Spitze, Aluminium

corner protection angle
20 x 20 x 1,8 mm,
without tip, aluminium

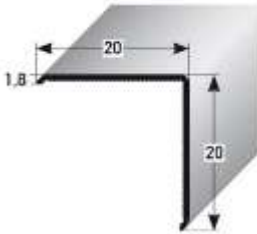

silberfarbig silver	1,0	65810-8	11,12	65792-7	6,90
	1,25	65812-2	13,88	65794-1	8,62
	2,5	65814-6	27,72	65796-5	17,26
edelstahlfarbig Feinschliff fine-honed stainless steel coloured	1,0	65816-0	16,74	65798-9	12,54
	1,25	65818-4	20,90	65800-9	15,68
	2,5	65820-7	41,78	65802-3	31,36
Pulverbeschichtet nach RAL9016 Verkehrsweiß powder RAL9016	1,0	65834-4	14,16	65828-3	10,16
	1,25	65836-8	17,72	65830-6	12,72
	2,5	65838-2	35,42	65832-0	25,44
Pulverbeschichtet nach RAL; Preis ab 150 lfm. powder RAL; price from 150m	1,0	65822-1	17,84	65804-7	13,66
	1,25	65824-5	22,32	65806-1	17,08
	2,5	65826-9	44,62	65808-5	34,18
Pulvern nach RAL unter 150 lfm. auf Anfrage powdered (RAL) less than 150m on request					

338 Eckschutzwinkel 25 x 25 x 1,9 mm, ohne Spitze, Aluminium

corner protection angle
25 x 25 x 1,9 mm,
without tip, aluminium

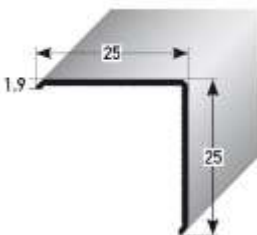

silberfarbig silver	1,0	65888-7	12,46	65870-2	8,32
	1,25	65890-0	15,60	65872-6	10,40
	2,5	65892-4	31,22	65874-0	20,78
edelstahlfarbig Feinschliff fine-honed stainless steel coloured	1,0	65894-8	17,84	65876-4	13,66
	1,25	65896-2	22,32	65878-8	17,08
	2,5	65898-6	44,58	65880-1	34,16
Pulverbeschichtet nach RAL9016 Verkehrsweiß powder RAL9016	1,0	65912-9	15,40	65906-8	11,40
	1,25	65914-3	19,24	65908-2	14,24
	2,5	65916-7	38,44	65910-5	28,50
Pulverbeschichtet nach RAL; Preis ab 150 lfm. powder RAL; price from 150m	1,0	65900-6	19,58	65882-5	15,38
	1,25	65902-0	24,46	65884-9	19,22
	2,5	65904-4	48,90	65886-3	38,46
Pulvern nach RAL unter 150 lfm. auf Anfrage powdered (RAL) less than 150m on request					

503 Eckschutzwinkel 30 x 30 x 1,9 mm, ohne Spitze, Aluminium

corner protection angle
30 x 30 x 1,9 mm,
without tip, aluminium

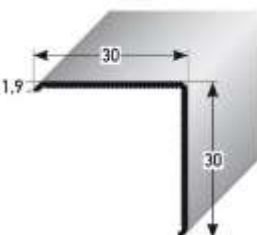

silberfarbig silver	1,0	71434-7	14,14	71410-1	10,00
	1,25	71436-1	17,70	71412-5	12,52
	2,5	71438-5	35,38	71414-9	25,00
edelstahlfarbig Feinschliff fine-honed stainless steel coloured	1,0	71440-8	20,54	71416-3	16,40
	1,25	71442-2	25,72	71418-7	20,50
	2,5	71444-6	51,36	71420-0	40,98
Pulverbeschichtet nach RAL9016 Verkehrsweiß powder RAL9016	1,0	71446-0	17,84	71422-4	13,70
	1,25	71448-4	22,32	71424-8	17,14
	2,5	71450-7	44,60	71426-2	34,24
Pulverbeschichtet nach RAL; Preis ab 150 lfm. powder RAL; price from 150m	1,0	71452-1	22,60	71428-6	18,44
	1,25	71454-5	28,24	71430-9	23,06
	2,5	71456-9	56,50	71432-3	46,14
Pulvern nach RAL unter 150 lfm. auf Anfrage powdered (RAL) less than 150m on request					

Lieferzeit f. Pulverbeschichtet auf Anfrage/ delivery time for powder coating on request

3. WAND-, KANTENSCHUTZ- & SPEZIALPROFILE/ 3. WALL+CORNER PROTECTION+SPECIAL PROFILES

Andere Abmaße auf Anfrage
 other dimensions on demand

Eckschutzwinkel mit Spitze aus Edelstahl (V2A)					
corner protection angles with tip out of stainless steel (V2A)					
Material/material	L / l (m)	selbstklebend self-adhesive	€/Stk./pcs.	ohne alles plain	€/Stk./pcs.

481 Eckschutzwinkel 20 x 20 x 1,0 mm, Edelstahl matt, dreifach gekantet

corner protection angle
 20 x 20 x 1,0 mm, stainless steel
 matt, triple edged

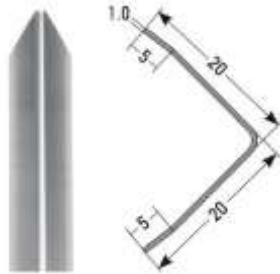

Edelstahl matt stainless steel matt	1,0	70958-9	15,32	70966-4	13,56
	1,25	70960-2	19,12	70968-8	16,94
	1,5	70962-6	22,96	70970-1	20,36
	2,5	70964-0	38,20	70972-5	33,90

**Andere Eloxalfarben siehe
 Abschnitt 6, Lieferzeit 14 Tage**
 other anodized colours see
 section 6, delivery time 14 days

Eckschutzwinkel mit Spitze aus Edelstahl (V2A) und Aluminium						
corner protection angles with tip out of stainless steel (V2A) and aluminium						
Dicke (mm)/ thickness	L / l (m)	selbstklebend self-adhesive	gebohrt siehe* drilled see*	€/Stk./pcs.	ohne alles/ plain	€/Stk./pcs.

209 Eckschutzwinkel 30 x 30 mm, dreifach gekantet

corner protection angle
 30 x 30 mm, triple edged



*** Bitte Bohrtyp
 angeben:**

- 01 einseitig seitlich
- 02 einseitig mittig
- 03 wechselseitig seitlich
- 04 wechselseitig mittig
- 05 im Knick

*** Please specify drill holes:**

- 01 single sided laterally
- 02 single sided centrally
- 03 alternating sides laterally
- 04 alternating sides centrally
- 05 in edge

Edelstahl matt stainless steel matt	1,0 mm	1,0	60824-0	60812-7	22,96	60800-4	20,36
		1,25	60825-7	60813-4	28,64	60801-1	25,40
		1,5	66238-9	66236-5	34,40	66234-1	30,52
		2,5	60826-4	60814-1	57,34	60802-8	50,92
	1,5 mm	1,0	60828-8	60816-5	34,38	60804-2	30,54
		1,25	60829-5	60817-2	42,98	60805-9	38,16
		1,5	66244-0	66242-6	51,58	66240-2	45,86
		2,5	60830-1	60818-9	85,90	60806-6	76,36
	2,0 mm	1,0	60832-5	60820-2	45,82	60808-0	40,72
		1,25	60833-2	60821-9	57,32	60809-7	50,92
		1,5	66250-1	66248-8	68,70	66246-4	61,06
		2,5	60834-9	60822-6	114,56	60810-3	101,72
Alu walzblank Alu mill finish	1,5 mm	1,0	60960-5	60958-2	15,90	60956-8	10,40
		1,5	66258-7	66256-3	23,84	66254-9	15,58
		2,5	60961-2	60959-9	39,76	60957-5	26,04
	2,0 mm	1,0	60680-2	60970-4	18,86	60968-1	13,86
		1,5	66264-8	66262-4	28,26	66260-0	20,78
		2,5	60690-1	60971-1	47,10	60969-8	34,50
Alu silber elox. silver anodized	1,5 mm	1,0	60966-7	60964-3	21,18	60962-9	15,68
		1,5	66270-9	66268-6	31,74	66266-2	23,54
		2,5	60967-4	60965-0	52,84	60963-6	39,18
	2,0 mm	1,0	60976-6	60974-2	24,10	60972-8	19,04
		1,5	66276-1	66274-7	36,16	66272-3	28,56
		2,5	60977-3	60975-9	60,22	60973-5	47,64

passende Schrauben siehe Abschnitt 12
 suitable screws see section 12

3. WAND-, KANTENSCHUTZ- & SPEZIALPROFILE/ 3. WALL+CORNER PROTECTION+SPECIAL PROFILES

Andere Eloxfarben siehe
Abschnitt 6, Lieferzeit 14 Tage
other anodized colours see section 6,
delivery time 14 days

Andere Abmaße auf Anfrage
other dimensions on demand

Eckschutzwinkel mit Spitze aus Edelstahl (V2A) und Aluminium						
corner protection angles with tip out of stainless steel (V2A) and aluminium						
Dicke (mm)/ thickness	L / l (m)	selbstklebend self-adhesive	gebohrt siehe* drilled see*	€/Stk./pcs.	ohne alles/ plain	€/ Stk./pcs.

210 Eckschutzwinkel 40 x 40 mm, dreifach gekantet

corner protection angle
40 x 40 mm, triple edged

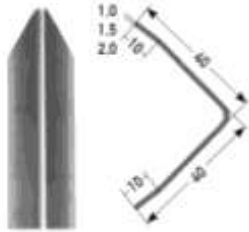

* Bitte Bohrtyp
angeben:

- 01 einseitig seitlich
- 02 einseitig mittig
- 03 wechselseitig seitlich
- 04 wechselseitig mittig
- 05 im Knick

* Please specify drill holes:

- 01 single sided laterally
- 02 single sided centrally
- 03 alternating sides laterally
- 04 alternating sides centrally
- 05 in edge

Edelstahl matt stainless steel matt	1,0 mm	1,0	60185-2	60848-6	30,54	60836-3	28,00
		1,25	60190-6	60849-3	38,16	60837-0	34,94
		1,5	66284-6	66282-2	45,86	66280-8	42,00
		2,5	60200-2	60850-9	76,36	60838-7	69,94
	1,5 mm	1,0	60165-4	60852-3	45,82	60840-0	42,00
		1,25	60170-8	60853-0	57,32	60841-7	52,46
		1,5	66290-7	66288-4	68,70	66286-0	63,02
		2,5	60180-7	60854-7	114,54	60842-4	104,94
	2,0 mm	1,0	60650-5	60856-1	61,12	60844-8	55,98
		1,25	60655-0	60857-8	76,38	60845-5	69,98
		1,5	66296-9	66294-5	91,64	66292-1	83,98
		2,5	60660-4	60858-5	152,70	60846-2	139,96
Alu walzblank alu mill finish	1,5 mm	1,0	60982-7	60980-3	18,86	60978-0	13,16
		1,5	66304-1	66302-7	28,26	66300-3	19,74
		2,5	60983-4	60981-0	47,10	60979-7	32,92
	2,0 mm	1,0	60992-6	60990-2	21,70	60665-9	17,62
		1,5	66310-2	66308-9	32,54	66306-5	26,44
		2,5	60993-3	60991-9	54,22	60675-8	44,12
Alu silber elox. silver anodized	1,5 mm	1,0	60988-9	60986-5	21,70	60984-1	20,14
		1,5	66316-4	66314-0	32,54	66312-6	30,20
		2,5	60989-6	60987-2	54,22	60985-8	50,26
	2,0 mm	1,0	60998-8	60996-4	25,80	60994-0	24,56
		1,5	66322-5	66320-1	38,70	66318-8	36,86
		2,5	60999-5	60997-1	64,40	60995-7	61,50

211 Eckschutzwinkel 50 x 50 mm, Edelstahl matt, dreifach gekantet

corner protection angle
50 x 50 mm, stainless
steel matt, triple edged

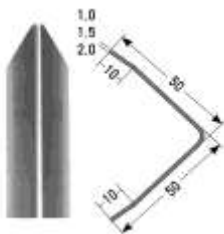

* Bitte Bohrtyp
angeben:

- 01 einseitig seitlich
- 02 einseitig mittig
- 03 wechselseitig seitlich
- 04 wechselseitig mittig
- 05 im Knick

* Please specify drill holes:

- 01 single sided laterally
- 02 single sided centrally
- 03 alternating sides laterally
- 04 alternating sides centrally
- 05 in edge

Edelstahl matt stainless steel matt	1,0 mm	1,0	60896-7	60884-4	38,18	60872-1	34,96
		1,25	60897-4	60885-1	47,70	60873-8	43,70
		1,5	66330-0	66328-7	57,32	66326-3	52,46
		2,5	60898-1	60886-8	95,42	60874-5	87,40
	1,5 mm	1,0	60900-1	60888-2	57,32	60876-9	52,54
		1,25	60901-8	60889-9	71,64	60877-6	65,64
		1,5	66336-2	66334-8	86,00	66332-4	78,78
		2,5	60902-5	60890-5	143,18	60878-3	131,22
	2,0 mm	1,0	60904-9	60892-9	76,38	60880-6	69,98
		1,25	60905-6	60893-6	95,46	60881-3	87,46
		1,5	66342-3	66340-9	114,58	66338-6	104,94
		2,5	60906-3	60894-3	190,94	60882-0	174,92

Andere Gradzahlen auf Anfrage erhältlich! Other degree values on request!

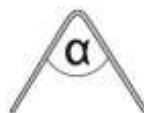

3. WAND-, KANTENSCHUTZ- & SPEZIALPROFILE/ 3. WALL+CORNER PROTECTION+SPECIAL PROFILES

Andere Abmaße auf Anfrage
other dimensions on demand

Edelstahl-Abkantprofile, matt, mit Schutzfolie				
stainless steel edge profiles, matt, with protective foil				
Koffernr./ case no.	L / l (m)	AxBxC (mm)	Art./ref.	€/Stk./pcs.

212-214 Deko-Winkel 1,5 / 2,0 / 3,0 mm, Edelstahl matt, ungebohrt

deco-angle 1,5 / 2,0 / 3,0 mm
stainless steel matt, undrilled

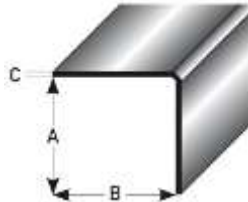

2,5 m	212	20 x 20 x 1,5	60210-1	57,34
	213	30 x 30 x 1,5	60220-0	85,84
	214	40 x 40 x 1,5	60230-9	114,54
	213	30 x 30 x 2,0	60430-3	114,52
	214	40 x 40 x 2,0	60440-2	152,70
	214	40 x 40 x 3,0	60470-9	229,02

Bohrung oder selbstklebend auf Anfrage erhältlich
drill holes or self adhesive available on request

215- 217 Deko-L-Winkel 1,5 / 2,0 mm, Edelstahl matt, ungebohrt

deco-L-angle 1,5 / 2,0 mm,
stainless steel matt, undrilled

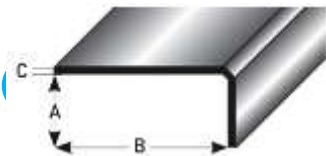

2,5 m	215	15 x 30 x 1,5	60240-8	64,46
	216	20 x 40 x 1,5	60250-7	85,84
	217	30 x 50 x 1,5	60260-6	114,54
	216	20 x 40 x 2,0	60450-1	114,52
	217	30 x 50 x 2,0	60460-0	152,70

Bohrung oder selbstklebend auf Anfrage
drill holes or self adhesive on request

227 Ausgleichsprofil mit zwei Befestigungsschenkel, Edelstahl matt, gebohrt

level compensation profile with two
attachment flanges, stainless steel matt,
drilled

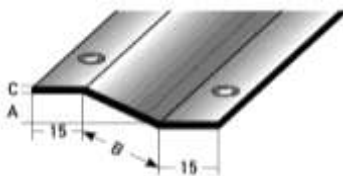

2,5 m		8 x 30 x 1,0	60330-6	77,46
		10 x 30 x 1,0	60340-5	82,96
		13 x 35 x 1,5	60350-4	114,54
		15 x 40 x 1,5	60360-3	128,88
		22 x 55 x 1,5	60370-2	157,48
		13 x 35 x 2,0	60480-8	152,70
		15 x 40 x 2,0	60490-7	171,82
		20 x 80 x 3,0	60491-4	235,42

218- 222 477 Einschubprofile, Edelstahl matt, gebohrt

insert profile, stainless steel matt,
drilled

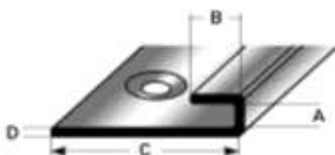

AxBxCxD (mm)				
2,5 m	477	5 x 5 x 34 x 1,0	60268-2	34,12
	218	8 x 8 x 34 x 1,0	60270-5	37,94
	219	10 x 10 x 34 x 1,0	60280-4	47,34
	220	13 x 10 x 34 x 1,0	60290-3	61,58
	221	15 x 10 x 34 x 1,0	60300-9	70,98
	222	22 x 10 x 34 x 1,0	60310-8	77,04

3. WAND-, KANTENSCHUTZ- & SPEZIALPROFILE/ 3. WALL+CORNER PROTECTION+SPECIAL PROFILES

Miniwinkel, profiliert, ungebohrt, Sichtseite außen					
mini angle profiles, undrilled, visible side outside					
Material/material	L / l (m)	m/VE/unit	AxBxC mm	Art./ref.	€/m

235 Miniwinkel gleichschenkelig, Innenradius 0,3 mm, außen Rundkante, ungebohrt

mini angle profile, equal size sides, inside radius 0,3 mm, round edge, undrilled



Edelstahl matt/ stainless steel matt	2,7	27 m	10 x 10 x 1,0	44800-6	10,26
Edelstahl matt/ stainless steel matt			10 x 10 x 1,5	44802-0	11,60
Messing poliert/ brass polished			10 x 10 x 1,2	44804-4	11,34
Edelstahl matt/ stainless steel matt	2,7	27 m	15 x 15 x 1,0	44806-8	8,18
Edelstahl matt/ stainless steel matt			15 x 15 x 1,5	44808-2	15,14
Messing poliert/ brass polished			15 x 15 x 1,0	44810-5	15,72
Edelstahl matt/ stainless steel matt	2,7	27 m	20 x 20 x 1,0	44812-9	9,22
Edelstahl matt/ stainless steel matt			20 x 20 x 1,5	44814-3	19,14
Messing poliert/ brass polished			20 x 20 x 1,0	44816-7	21,46

236 Miniwinkel ungleichschenkelig, Innenradius 0,3 mm, außen Rundkante, ungebohrt

mini angle profile, different size sides, inside radius 0,3 mm, round edge, undrilled

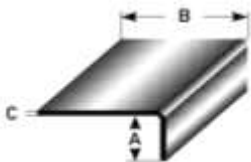

Edelstahl matt/ stainless steel matt	2,7	27 m	3,5x16,5x1,0	44818-1	9,94
Messing poliert/ brass polished			3,5x16,5x1,2	44820-4	11,04
Edelstahl matt/ stainless steel matt	2,7	27 m	3 x 25 x 1,0	44822-8	8,18
Messing poliert/ brass polished			3 x 25 x 1,0	44824-2	15,72
Edelstahl matt/ stainless steel matt	2,7	27 m	2,5x33,5x1,0	44826-6	9,22
Edelstahl matt/ stainless steel matt			3 x 34 x 1,0	44828-0	9,22
Messing poliert/ brass polished			3 x 34 x 1,0	44830-3	21,46
Edelstahl matt/ stainless steel matt	2,7	27 m	4 x 24 x 1,5	44832-7	15,14
Edelstahl matt/ stainless steel matt	2,7	27 m	5 x 15 x 1,0	44834-1	10,26
Edelstahl matt/ stainless steel matt			5 x 15 x 1,5	44836-5	11,60
Messing poliert/ brass polished			5 x 15 x 1,2	44838-9	11,34
Edelstahl matt/ stainless steel matt	2,7	27 m	5 x 22 x 1,0	44840-2	8,18
Edelstahl matt/ stainless steel matt			5 x 22 x 1,5	44842-6	15,14
Messing poliert/ brass polished			5 x 22 x 1,0	44844-0	15,72
Edelstahl matt/ stainless steel matt	2,7	27 m	5 x 32 x 1,0	44846-4	9,22
Edelstahl matt/ stainless steel matt			5 x 32 x 1,5	44848-8	19,14
Messing poliert/ brass polished			5 x 32 x 1,0	44850-1	21,46
Edelstahl matt/ stainless steel matt	2,7	27 m	6 x 21 x 1,0	44852-5	8,18
Edelstahl matt/ stainless steel matt			6 x 21 x 1,5	44854-9	15,14
Messing poliert/ brass polished			6 x 21 x 1,0	44856-3	15,72
Edelstahl matt/ stainless steel matt	2,7	27 m	8 x 19 x 1,0	44858-7	8,18
Edelstahl matt/ stainless steel matt			8 x 19 x 1,5	44860-0	15,14
Messing poliert/ brass polished			8 x 19 x 1,0	44862-4	15,72
Edelstahl matt/ stainless steel matt	2,7	27 m	8 x 29 x 1,0	44864-8	9,22
Edelstahl matt/ stainless steel matt			8 x 29 x 1,5	44866-2	19,14
Messing poliert/ brass polished			8 x 29 x 1,0	44868-6	21,46
Edelstahl matt/ stainless steel matt	2,7	27 m	10 x 17 x 1,0	44870-9	8,18
Edelstahl matt/ stainless steel matt			10 x 17 x 1,5	44872-3	15,14
Messing poliert/ brass polished			10 x 17 x 1,0	44874-7	15,72
Edelstahl matt/ stainless steel matt	2,7	27 m	10 x 27 x 1,0	44876-1	9,62
Edelstahl matt/ stainless steel matt			10 x 27 x 1,5	44878-5	19,14
Messing poliert/ brass polished			10 x 27 x 1,0	44880-8	21,46
Edelstahl poliert/ stainless steel polished	2,7	27 m	12 x 26 x 1,5	44882-2	10,04
Edelstahl matt/ stainless steel matt			15 x 22 x 1,0	44884-6	9,22
Edelstahl matt/ stainless steel matt			15 x 22 x 1,5	44886-0	19,14
Messing poliert/ brass polished			15 x 22 x 1,0	44888-4	21,46

Maßtoleranz ± 1mm, andere Abmessungen und Oberflächen auf Anfrage

tolerance ± 1 mm, other sizes and finishes available on request

3. WAND-, KANTENSCHUTZ- & SPEZIALPROFILE/ 3. WALL+CORNER PROTECTION+SPECIAL PROFILES

Andere Abmaße, ungebohrt oder Lochbild auf Anfrage
other dimensions, undrilled or custom drill hole on demand

Niveausgleichsprofile für individuelle Höhen, Edelstahl matt, VE 1 Stück
levelling profiles for individual heights, stainless steel matt, unit 1 pcs.

397 Niveausgleich 15 x 20 x 1,5 / 2,0 / 3,0 mm, Edelstahl matt, gebohrt

level compensation profile 15 x 20 x 1,5 / 2,0 / 3,0 mm, stainless steel matt, drilled

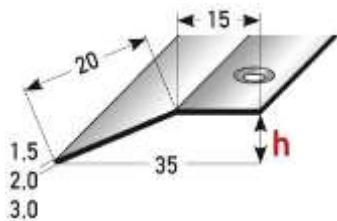

L / l (m)	1,5 mm		2,0 mm		3,0 mm	
	Materialstärke/ thickness	Art./ref.	Materialstärke/ thickness	Art./ref.	Materialstärke/ thickness	Art./ref.
1,00	€ /Stk./pcs.	21,30	€ /Stk./pcs.	26,70	€ /Stk./pcs.	35,66
1,25	67370-5	26,62	67376-7	33,36	67382-8	44,54
2,50	67372-9	53,20	67378-1	66,72	67384-2	89,14
	67374-3		67380-4		67386-6	

3,0 mm Material für
Gabelstapler +
Hubwagen
3,0 mm material for
forklifts + pallet trucks

individuelle Höhe = h immer angeben!

individual height = h always specify!

Wir empfehlen bei dieser Profilbreite eine maximale Ausgleichshöhe von bis zu 8 mm.
We recommend a maximum height compensation of up to 8 mm for this profile width.

398 Niveausgleich 15 x 30 x 1,5 / 2,0 / 3,0 mm, Edelstahl matt, gebohrt

level compensation profile 15 x 30 x 1,5 / 2,0 / 3,0 mm, stainless steel matt, drilled

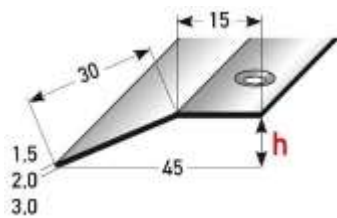

L / l (m)	1,5 mm		2,0 mm		3,0 mm	
	Materialstärke/ thickness	Art./ref.	Materialstärke/ thickness	Art./ref.	Materialstärke/ thickness	Art./ref.
1,00	€ /Stk./pcs.	25,90	€ /Stk./pcs.	32,82	€ /Stk./pcs.	44,90
1,25	67394-1	32,40	67400-9	41,06	67406-1	56,12
2,50	67396-5	64,76	67402-3	82,10	67408-5	112,22
	67398-9		67404-7		67410-8	

3,0 mm Material für
Gabelstapler +
Hubwagen
3,0 mm material for
forklifts + pallet trucks

individuelle Höhe = h immer angeben!

individual height = h always specify!

Wir empfehlen bei dieser Profilbreite eine maximale Ausgleichshöhe von bis zu 15 mm.
We recommend a maximum height compensation of up to 15 mm for this profile width.

241 Niveausgleich 20 x 50 x 1,5 / 2,0 / 3,0 mm, Edelstahl matt, gebohrt

level compensation profile 20 x 50 x 1,5 / 2,0 / 3,0 mm, stainless steel matt, drilled

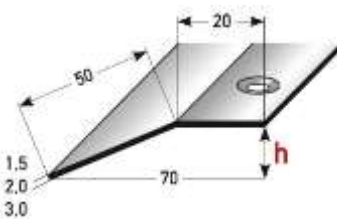

L / l (m)	1,5 mm		2,0 mm		3,0 mm	
	Materialstärke/ thickness	Art./ref.	Materialstärke/ thickness	Art./ref.	Materialstärke/ thickness	Art./ref.
1,00	€ /Stk./pcs.	40,10	€ /Stk./pcs.	53,44	€ /Stk./pcs.	80,18
1,25	60145-6	50,16	60635-2	66,82	60760-1	100,22
2,50	60150-0	100,20	60640-6	133,62	60765-6	200,42
	60160-9		60645-1		60770-0	

3,0 mm Material für
Gabelstapler +
Hubwagen
3,0 mm material for
forklifts + pallet trucks

individuelle Höhe = h immer angeben!

individual height = h always specify!

Wir empfehlen bei dieser Profilbreite eine maximale Ausgleichshöhe von bis zu 30 mm.
We recommend a maximum height compensation of up to 30 mm for this profile width.

3. WAND-, KANTENSCHUTZ- & SPEZIALPROFILE/ 3. WALL+CORNER PROTECTION+SPECIAL PROFILES

Andere Abmaße auf Anfrage/
other dimensions on demand
passende Edelstahlschrauben siehe
Abschnitt 12/ suitable stainless steel
screws see section 12

Spezialprofile mit Schutzfolie, VE 1 Stück				
custom profiles with protective film, unit 1 pcs.				
Material/material	L / l (m)	AxBxC (mm)	Art./ref.	€/m

230 Kabelabdeckung, robust, beidseitig selbstklebend

cable cover, robust, double-sided,
self-adhesive

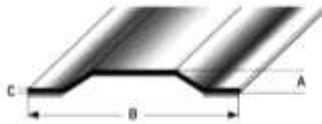

Edelstahl matt stainless steel matt	2,5 m	10 x 80 x 1,5	45500-4	68,70
		10 x 100 x 1,5	45505-9	80,18
		15 x 120 x 1,5	45510-3	91,60
ALU walzblank aluminum mill finish	2,5 m	10 x 80 x 2,0	45515-8	23,14
		10 x 100 x 2,0	45520-2	27,04
		15 x 120 x 3,0	45525-7	30,86

Achtung: VDE-Vorschriften sind zu beachten !! Alternative Materialstärken 2,0 und 3,0 mm auf Anfrage.
Please adhere to the law when installing electric cables! Alternative material thicknesses 2,0 and 3,0 mm on request.

231 Mattenrahmenprofil, Edelstahl matt, gebohrt

frame profile, stainless steel matt, drilled



Rahmenfertigung
auf Anfrage/
frame manufacturing
on request

L / l (m)	AxBxC (mm)	Art./ref.	€/m
2,5 m	10 x 30 x 1,5	45541-7	34,38
	15 x 30 x 1,5	45540-0	34,38
	20 x 40 x 1,5	45545-5	42,98
	25 x 50 x 1,5	45550-9	51,56
	20 x 40 x 2,0	45555-4	57,22
	25 x 50 x 2,0	45560-8	68,72

232 Natursteintrennprofil, Edelstahl matt, gebohrt

stone separation profile, stainless steel matt, drilled

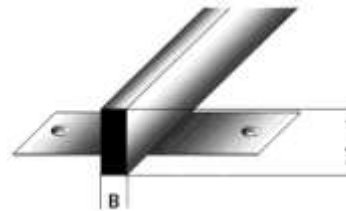

Profil auch ohne
Befestigungslaschen auf
Anfrage erhältlich/
profile also available without
fastening strips on request

L / l (m)	AxB (mm)	Art./ref.	€/m
Länge auf Anfrage/ length on request	10 x 3	45575-2	42,66
	15 x 3	45580-6	49,18
	20 x 3	45585-1	56,24
	5 x 5	45590-5	40,30
	10 x 5	45595-0	51,54
	12 x 5	45600-1	56,24
	15 x 5	45605-6	63,34
	20 x 5	45610-0	75,12

andere Höhen auf Anfrage/ other heights on request

233 Läuferabschlussschiene schwer, Edelstahl matt, gebohrt

carpet end profile, heavy duty, stainless steel matt, drilled

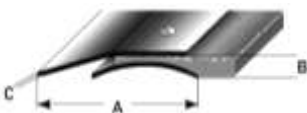

für freiliegende Montage
ohne Untergrundbefestigung
for exposed installation
without base attachment

L / l (m)	AxBxC (mm)	Art./ref.	€/m
2,5 m	50 x 5 x 1,5	45625-4	77,90
	60 x 10 x 1,5	45630-8	83,56
	70 x 15 x 1,5	45635-3	89,32

Bitte die Läuferdicke angeben! Please specify carpet thickness.

Alternative Materialstärken 2,0 & 3,0 mm auf Anfrage
alternative material thickness 2,0 and 3,0 mm on request

234 Flieseneckschutz, Edelstahl matt 1,0 mm

ceramic tile corner protection, stainless steel matt 1,0 mm

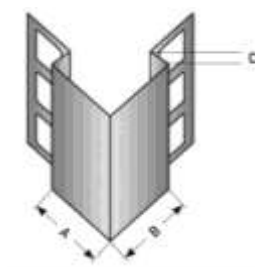

verdeckter Befestigungsschenkel
Hohlräume mit Mörtel hinterfüllen
hidden attachment flanges
fill any gaps with concrete

L / l (m)	AxBxC (mm)	Art./ref.	€/m
2,5 m	25 x 25 x 6	45650-6	58,60
	25 x 25 x 8	45655-1	60,96
	25 x 25 x 10	45660-5	64,14
	25 x 25 x 12,5	45665-0	67,86
	30 x 30 x 6	45670-4	61,98
	30 x 30 x 8	45675-9	64,36
	30 x 30 x 10	45680-3	67,54
	30 x 30 x 12,5	45685-8	71,24
	40 x 40 x 6	45690-2	68,82
	40 x 40 x 8	45695-7	71,16
	40 x 40 x 10	45700-8	74,34
	40 x 40 x 12,5	45705-3	78,02

3 Teile punktgeschweißt Einbau bündig mit Belag
3 parts spot welded installation flush with flooring

andere Abmessungen und Oberflächen auf Anfrage
other sizes and surface treatments on request

4. ÜBERGANGSPROFILE AUS ALUMINIUM, EDELSTAHL UND MESSING

4. CONNECTING PROFILES OUT OF ALUMINIUM + STAINLESS STEEL + BRASS

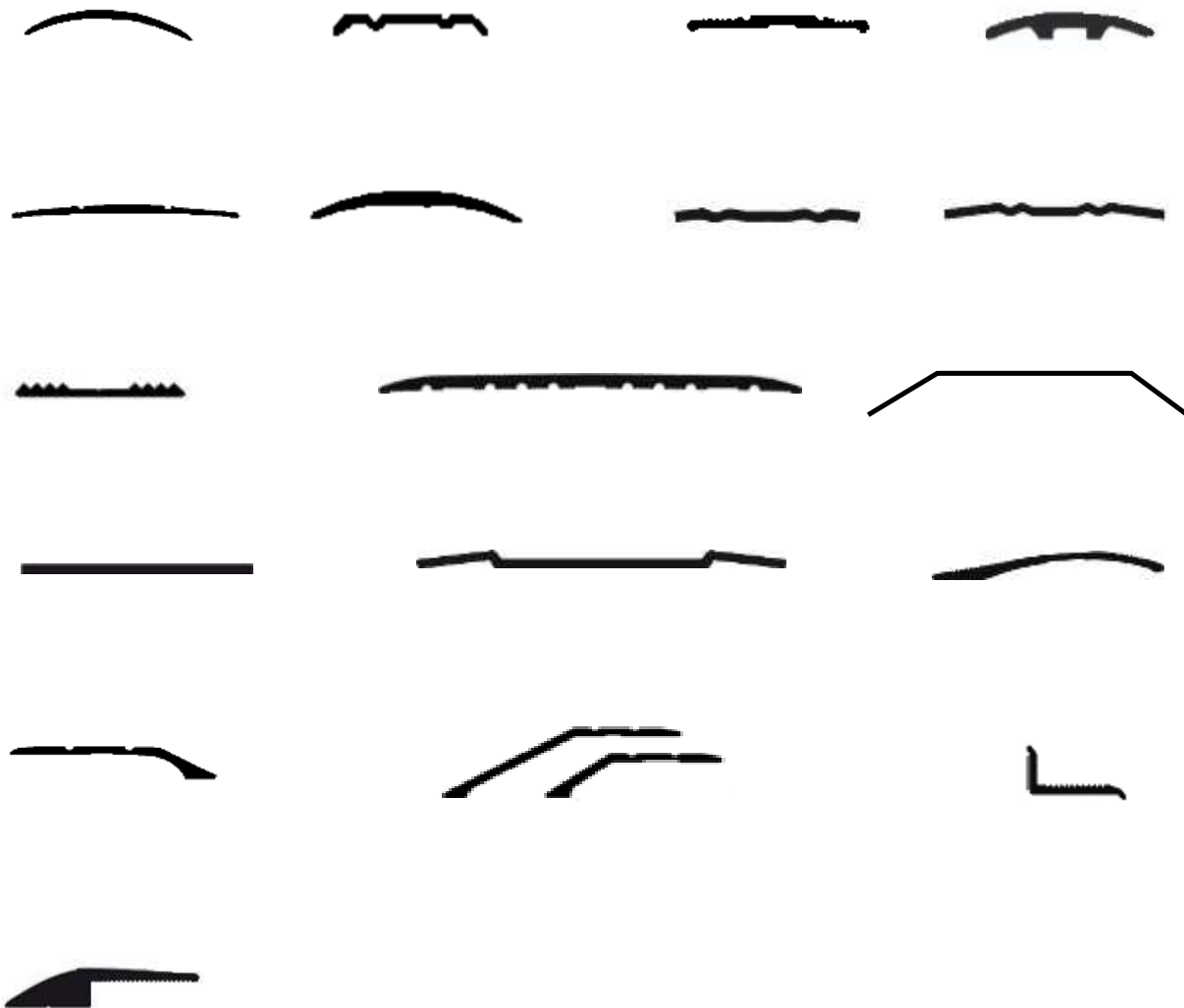

4. ÜBERGANGSPROFILE/ 4. CONNECTING PROFILES

Seitlich gebohrt, ungebohrt oder als Flachstreifen auf Anfrage erhältlich!
Laterally drilled, undrilled or as flat profile available on demand!

Profi-Pack à 10 Stück im Bund			
professional packing à 10 pcs.			
Dicke + Befestigung thickness + fixing	L / l (m)	Art./ref.	€/Stk./pcs.

SB-Pack incl. Schr./ Dübel; VE 20 Stk.	
self-service-pack with screws/ dowels; à 20 pcs.	
Art./ref.	€/Stk./pcs.

142 Übergangsprofil 20 mm, Messing poliert, mit Schutzfolie

connecting profile 20 mm, brass polished, with protective film

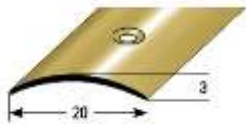

1,2 mm	mittig gebohrt centrally drilled	0,9	41200-7	8,20
		1,0	41210-6	9,10
		2,7	41220-5	24,56

41201-4	9,44
41211-3	10,50
41221-2	28,32

Bitte fordern Sie unsere Pflegehinweise für Messingprofile an!
Please ask for our care tips for brass profiles!

143 Übergangsprofil 20 mm, Edelstahl poliert, mit Schutzfolie

connecting profile 20 mm, stainless steel polished, with protective film

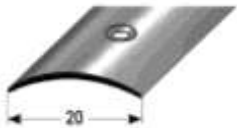

1,0 mm	mittig gebohrt centrally drilled	0,9	41230-4	6,20
		1,0	41240-3	6,86
		2,7	41250-2	18,58
1,5 mm	mittig gebohrt centrally drilled	1,0	42220-4	7,62
		2,7	42230-3	20,42
2,0 mm	mittig gebohrt centrally drilled	1,0	42250-1	8,78
		2,7	42260-0	23,78

41231-1	7,18
41241-0	7,98
41251-9	21,50
42221-1	8,66
42231-0	23,44
42251-8	9,98
42261-7	26,82

144 Übergangsprofil 20 mm, Edelstahl matt, mit Schutzfolie

connecting profile 20 mm, stainless steel matt, with protective film



1,0 mm	mittig gebohrt centrally drilled	1,0	42280-8	8,22
		2,7	42290-7	22,30
1,5 mm	mittig gebohrt centrally drilled	1,0	42310-2	10,46
		2,7	42320-1	28,26
2,0 mm	mittig gebohrt centrally drilled	1,0	42340-9	12,80
		2,7	42350-8	34,46

42281-5	9,36
42291-4	25,24
42311-9	11,64
42321-8	31,38
42341-6	13,94
42351-5	37,54

524 Stegübergangsprofil 20 x 3,0 mm, Aluminium eloxiert, mittig gebohrt

connecting profile with bars 20 x 3,0 mm, aluminium anodized, centrally drilled

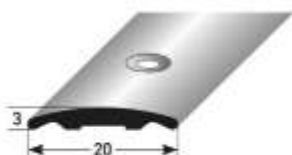

Farbe/colour	L / l (m)	Art./ref.	€/Stk./pcs.
silberfarbig silver	0,9	72058-4	5,82
	2,7	72060-7	15,72
edelstahlfarbig Feinschliff fine-honed stainless steel coloured	0,9	72066-9	7,90
	2,7	72068-3	21,34

Art./ref.	€/Stk./pcs.
72062-1	6,82
72064-5	18,70
72070-6	8,92
72072-0	24,36

Andere Eloxalfarben siehe Abschnitt 6, Lieferzeit 14 Tage
other anodized colours see section 6, delivery time 14 days

4. ÜBERGANGSPROFILE/ 4. CONNECTING PROFILES

Seitlich gebohrt, ungebohrt oder als Flachstreifen auf Anfrage erhältlich!
 Laterally drilled, undrilled or as flat profile available on demand!

Profi-Pack à 10 Stück im Bund			
professional packing à 10 pcs.			
Dicke + Befestigung thickness + fixing	L / l (m)	Art./ref.	€/Stk./pcs.

SB-Pack incl. Schr./ Dübel; VE 20 Stk.	
self-service-pack with screws/ dowels; à 20 pcs.	
Art./ref.	€/Stk./pcs.

01 Übergangsprofil 28 mm, Messing poliert, mit Schutzfolie

connecting profile 28 mm,
brass polished, with
protective film



Bitte fordern Sie unsere Pflegehinweise für Messingprofile an!
 Please ask for our care tips for brass profiles!

Längen bis 5,0 m
auf Anfrage/ lengths up
to 5,0 m on request

1,0 mm	mittig gebohrt centrally drilled	0,9	03090-4	12,88	03091-1	14,04
		1,0	03100-0	14,32	03101-7	15,46
		2,0	03110-9	28,60	03111-6	30,90
		2,7	03120-8	38,56	03121-5	42,08
	seitlich gebohrt laterally drilled	0,9	03390-5	12,88	03391-2	14,04
		1,0	03400-1	14,32	03401-8	15,46
		2,0	03410-0	28,60	03411-7	30,90
		2,7	03420-9	38,56	03421-6	42,08
	selbstklebend self-adhesive	0,9	03093-5	14,64	03092-8	15,48
		1,0	03103-1	16,06	03102-4	16,92
		2,7	03123-9	43,34	03126-0	45,92
	1,2 mm	mittig gebohrt centrally drilled	0,9	03095-9	14,82	03096-6
1,0			03105-5	16,44	03106-2	17,56
2,7			03125-3	44,38	03122-2	47,86
seitlich gebohrt laterally drilled		0,9	03094-2	14,82	03099-7	15,96
		1,0	02104-9	16,44	03109-3	17,56
		2,7	03124-6	44,38	03129-1	47,86
selbstklebend self-adhesive		0,9	03097-3	16,52	03098-0	17,40
		1,0	03107-9	18,18	03108-6	19,04
		2,7	03127-7	49,08	03128-4	51,72

4. ÜBERGANGSPROFILE/ 4. CONNECTING PROFILES

Seitlich gebohrt, ungebohrt oder als Flachstreifen auf Anfrage erhältlich!

Laterally drilled, undrilled or as flat profile available on demand!

Profi-Pack à 10 Stück im Bund			
professional packing à 10 pcs.			
Dicke + Befestigung thickness + fixing	L / l (m)	Art./ref.	€/Stk./pcs.

SB-Pack incl. Schr./ Dübel; VE 20 Stk.	
self-service-pack with screws/ dowels; à 20 pcs.	
Art./ref.	€/Stk./pcs.

13 Übergangprofil 28 mm, Edelstahl poliert, mit Schutzfolie

connecting profile 28 mm, stainless steel polished, with protective film

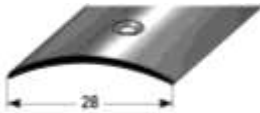

1,0 mm	mittig gebohrt centrally drilled	0,9	03190-1	5,00	03191-8	6,00
		1,0	03200-7	5,52	03201-4	6,52
		2,0	03210-6	11,12	03211-3	13,04
		2,7	03220-5	14,98	03221-2	18,00
	seitlich gebohrt laterally drilled	0,9	03490-2	5,00	03491-9	6,00
		1,0	03500-8	5,52	03501-5	6,52
		2,0	03510-7	11,12	03511-4	13,04
		2,7	03520-6	14,98	03521-3	18,00
	selbstklebend self-adhesive	0,9	03193-2	6,50	03192-5	7,26
		1,0	03203-8	7,24	03202-1	7,98
		2,7	03223-6	19,50	03224-3	21,80
	1,5 mm	mittig gebohrt centrally drilled	1,0	42370-6	7,52	42371-3
2,7			42380-5	20,34	42381-2	23,38
selbstklebend self-adhesive		1,0	42400-0	9,04	42401-7	9,80
		2,7	42410-9	24,40	42411-6	26,70
2,0 mm	mittig gebohrt centrally drilled	1,0	42430-7	9,02	42431-4	10,02
		2,7	42440-6	24,34	42441-3	27,36
	selbstklebend self-adhesive	1,0	42460-4	10,52	42461-1	11,26
		2,7	42470-3	28,44	42471-0	30,72

14 Übergangprofil 28 mm, Edelstahl matt, mit Schutzfolie

connecting profile 28 mm, stainless steel matt, with protective film

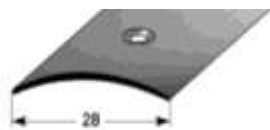

1,0 mm	mittig gebohrt centrally drilled	0,9	03690-6	6,52	03691-3	7,52	
		1,0	03700-2	7,26	03701-9	8,24	
		2,7	03720-0	19,60	03721-7	22,60	
	seitlich gebohrt laterally drilled	0,9	03790-3	6,52	03791-0	7,52	
		1,0	03800-9	7,26	03801-6	8,24	
		2,7	03820-7	19,60	03821-4	22,60	
	selbstklebend self-adhesive	0,9	03890-0	8,04	03891-7	8,78	
		1,0	03900-6	8,76	03901-3	9,20	
		2,7	03920-4	23,66	03921-1	25,96	
	1,5 mm	mittig gebohrt centrally drilled	1,0	60005-3	10,22	60006-0	11,22
			2,7	60021-3	27,62	60023-7	30,64
		selbstklebend self-adhesive	1,0	60007-7	11,76	60024-4	12,46
2,7			60009-1	31,66	60026-8	34,02	
2,0 mm	mittig gebohrt centrally drilled	1,0	60530-0	13,56	60531-7	14,58	
		2,7	60542-3	36,66	60543-0	39,72	
	selbstklebend self-adhesive	1,0	60532-4	15,40	60533-1	16,16	
		2,7	60538-6	41,58	60539-3	43,82	

4. ÜBERGANGSPROFILE/ 4. CONNECTING PROFILES

Andere Eloxalfarben siehe
Abschnitt 6, Lieferzeit 14 Tage/
other anodized colours see section 6,
delivery time 14 days

Profi-Pack à 10 Stück im Bund			
professional packing à 10 pcs.			
Farbe/colour	L / l (m)	Art./ref.	€/Stk./pcs.

SB-Pack incl. Schr./ Dübel; VE 20 Stk.	
self-service-pack with screws/ dowels; à 20 pcs.	
Art./ref.	€/Stk./pcs.

05 Übergangprofil 28 x 1,5 mm, Aluminium eloxiert, mittig gebohrt

connecting profile 28 x 1,5 mm,
aluminium anodized,
centrally drilled

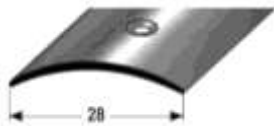

seitlich gebohrt auf Anfrage
laterally drilled on request

silberfarbig silver	0,9	08490-7	4,54
	1,0	08500-3	5,02
	2,0	08510-2	10,04
	2,7	08520-1	13,58
goldfarbig gold	0,9	08590-4	5,86
	1,0	08600-0	6,52
	2,0	08610-9	13,14
	2,7	08620-8	17,74
bronzefarbig hell bronze light	0,9	08690-1	6,22
	1,0	08700-7	6,92
	2,0	08710-6	13,88
	2,7	08720-5	18,70
bronzefarbig dunkel bronze dark	0,9	08790-8	6,22
	1,0	08800-4	6,92
	2,0	08810-3	13,88
	2,7	08820-2	18,70
gold hell gold light	0,9	70802-5	5,86
	1,0	70804-9	6,52
	2,0	70806-3	13,14
	2,7	70808-7	17,74
edelstahlfarbig Feinschliff fine-honed stainless steel coloured	0,9	70818-6	6,22
	1,0	70820-9	6,92
	2,0	70822-3	13,88
	2,7	70824-7	18,70
schwarz black	1,0	72076-8	6,92
	2,7	72078-2	18,70

08491-4	5,44
08501-0	5,96
08511-9	11,90
08521-8	16,20
08591-1	6,82
08601-7	7,62
08611-6	15,12
08621-5	20,42
08691-8	7,62
08701-4	8,46
08711-3	16,82
08721-2	22,76
08791-5	7,16
08801-1	7,92
08811-0	15,86
08821-9	21,38
70810-0	6,82
70812-4	7,62
70814-8	15,12
70816-2	20,42
70826-1	7,16
70828-5	7,92
70830-8	15,86
70832-2	21,38
72080-5	7,92
72082-9	21,38



Holzdekorfolie/ wood decor

Buche beech	1,0	38160-0	11,82
	2,7	38170-9	31,92
Eiche oak	1,0	38180-8	11,82
	2,7	38190-7	31,92
Ahorn maple	1,0	38200-3	11,82
	2,7	38210-2	31,92
Kirschbaum cherry wood	1,0	38220-1	11,82
	2,7	38225-6	31,92
Eiche rustikal rustic oak	1,0	38230-0	11,82
	2,7	38235-5	31,92

38161-7	12,86
38171-6	34,72
38181-5	12,86
38191-4	34,72
38201-0	12,86
38211-9	34,72
38221-8	12,86
38226-3	34,72
38231-7	12,86
38236-2	34,72

4. ÜBERGANGSPROFILE/ 4. CONNECTING PROFILES

Andere Eloxalfarben siehe
Abschnitt 6, Lieferzeit 14 Tage/
other anodized colours see section 6,
delivery time 14 days

Profi-Pack à 10 Stück im Bund			
professional packing à 10 pcs.			
Farbe/colour	L / l (m)	Art./ref.	€/Stk./pcs.

SB-Pack; VE 20 Stk.	
self-service-pack; à 20 pcs.	
Art./ref.	€/Stk./pcs.

05 Übergangprofil 28 x 1,5 mm, Aluminium eloxiert, selbstklebend

connecting profile 28 x 1,5 mm,
aluminium anodized,
self-adhesive

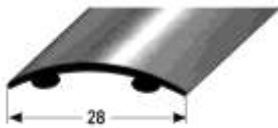

silberfarbig silver	0,9	08493-8	6,46
	1,0	08503-4	7,20
	2,7	08523-2	19,44
goldfarbig gold	0,9	08593-5	7,98
	1,0	08603-1	8,92
	2,7	08623-9	23,96
bronzefarbig hell bronze light	0,9	08693-2	8,32
	1,0	08703-8	9,20
	2,7	08723-6	24,92
bronzefarbig dunkel bronze dark	0,9	08793-9	8,32
	1,0	08803-5	9,20
	2,7	08823-3	24,92
gold hell gold light	0,9	70836-0	7,98
	1,0	70838-4	8,92
	2,7	70840-7	23,96
edelstahlfarbig Feinschliff fine-honed stainless steel coloured	0,9	70848-3	8,32
	1,0	70850-6	9,20
	2,7	70852-0	24,92
schwarz black	1,0	72084-3	9,20
	2,7	72086-7	24,92

08492-1	7,12
08502-7	7,82
08524-9	21,26
08592-8	8,56
08602-4	9,54
08624-6	25,78
08692-5	8,94
08702-1	9,96
08724-3	26,72
08792-2	8,94
08802-8	9,96
08824-0	26,72
70842-1	8,56
70844-5	9,54
70846-9	25,78
70854-4	8,94
70856-8	9,96
70858-2	26,72
72088-1	9,96
72090-4	26,72

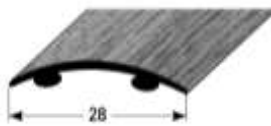

Holzdekorfolie/ wood decor			
	Buche beech	1,0	38100-6
	2,7	38110-5	39,26
Eiche oak	1,0	38120-4	14,58
	2,7	38130-3	39,26
Ahorn maple	1,0	38140-2	14,58
	2,7	38150-1	39,26
Kirschbaum cherry wood	1,0	38240-9	14,58
	2,7	38245-4	39,26
Eiche rustikal rustic oak	1,0	38250-8	14,58
	2,7	38255-3	39,26

38101-3	15,14
38111-2	41,00
38121-1	15,14
38131-0	41,00
38141-9	15,14
38151-8	41,00
38241-6	15,14
38246-1	41,00
38251-5	15,14
38256-0	41,00

Beispiel: oberes Übergangprofil
28 mm, Nr. 05, siehe Seite 54 + 55/
unteres Übergangprofil 38 mm,
Nr. 12, siehe Seite 60 + 61
upper connecting profile 28 mm,
no. 05, see page 54 + 55/
lower connecting profile 38 mm,
no. 12, see page 60 + 61



4. ÜBERGANGSPROFILE/ 4. CONNECTING PROFILES

Andere Eloxalfarben siehe
Abschnitt 6, Lieferzeit 14 Tage/
other anodized colours see section 6,
delivery time 14 days

10 Übergangprofil 24,5 x 1,25 mm, Aluminium eloxiert, mittig gebohrt

connecting profile 24,5 x 1,25 mm,
aluminium anodized,
centrally drilled



Profi-Pack à 10 Stück im Bund			
professional packing à 10 pcs.			
Farbe/colour	L / l (m)	Art./ref.	€/Stk./pcs.
silberfarbig silver	0,9	31105-8	5,64
	1,0	31110-2	6,24
	2,7	31115-7	16,86
goldfarbig gold	0,9	31120-1	5,76
	1,0	31125-6	6,38
	2,7	31130-0	17,26
bronzefarbig hell bronze light	0,9	31135-5	6,40
	1,0	31140-9	7,16
	2,7	31145-4	19,24
bronzefarbig dunkel bronze dark	0,9	31150-8	6,40
	1,0	31155-3	7,16
	2,7	31160-7	19,24

SB-Pack incl. Schr./ Dübel; VE 20 Stk.	
self-service-pack with screws/ dowels; à 20 pcs.	
Art./ref.	€/Stk./pcs.
31106-5	6,50
31111-9	7,26
31116-4	19,58
31121-8	6,66
31126-3	7,38
31131-7	19,98
31136-2	7,78
31141-6	8,62
31146-1	23,32
31151-5	7,32
31156-0	8,16
31161-4	21,96

10 Übergangprofil 24,5 x 1,25 mm, Aluminium eloxiert, selbstklebend

connecting profile 24,5 x 1,25 mm,
aluminium anodized,
self-adhesive



silberfarbig silver	0,9	31107-2	7,70
	1,0	31112-6	8,54
	2,7	31118-8	23,02
goldfarbig gold	0,9	31122-5	7,82
	1,0	31127-0	8,66
	2,7	31133-1	23,44
bronzefarbig hell bronze light	0,9	31137-9	8,48
	1,0	31142-3	9,42
	2,7	31148-5	25,40
bronzefarbig dunkel bronze dark	0,9	31152-2	8,48
	1,0	31157-7	9,42
	2,7	31163-8	25,40

31108-9	8,32
31113-3	9,20
31117-1	24,92
31123-2	8,46
31128-7	9,36
31132-4	25,24
31138-6	9,10
31143-0	10,10
31147-8	27,26
31153-9	9,10
31158-4	10,10
31162-1	27,26

11 Übergangprofil 27 x 1,7 mm, Aluminium eloxiert, mittig gebohrt

connecting profile 27 x 1,7 mm,
aluminium anodized,
centrally drilled



silberfarbig silver	0,9	23090-8	4,40
	1,0	23100-4	4,92
	2,0	23120-2	9,80
	2,7	23110-3	13,22
goldfarbig gold	0,9	23190-5	6,00
	1,0	23200-1	6,62
	2,0	23220-9	13,30
	2,7	23210-0	17,98
bronzefarbig hell bronze light	0,9	23290-2	6,60
	1,0	23300-8	7,34
	2,0	23320-6	14,76
	2,7	23310-7	19,84
bronzefarbig dunkel bronze dark	0,9	23390-9	6,60
	1,0	23400-5	7,34
	2,0	23420-3	14,76
	2,7	23410-4	19,84

23091-5	5,36
23101-1	5,84
23111-0	15,80
23191-2	6,90
23201-8	7,66
23211-7	20,68
23291-9	7,98
23301-5	8,92
23311-4	23,94
23391-6	7,52
23401-2	8,36
23411-1	22,56

11 Übergangprofil 27 x 1,7 mm, Aluminium eloxiert, selbstklebend

connecting profile 27 x 1,7 mm,
aluminium anodized,
self-adhesive



silberfarbig silver	0,9	23093-9	6,26
	1,0	23103-5	6,92
	2,7	23123-3	18,66
goldfarbig gold	0,9	23193-6	7,84
	1,0	23203-2	8,72
	2,7	23223-0	23,58
bronzefarbig hell bronze light	0,9	23293-3	8,52
	1,0	23303-9	9,44
	2,7	23323-7	25,46
bronzefarbig dunkel bronze dark	0,9	23393-0	8,52
	1,0	23403-6	9,44
	2,7	23423-4	25,46

23092-2	6,90
23102-8	7,56
23122-6	20,54
23192-9	8,48
23202-5	9,42
23222-3	25,40
23292-6	9,12
23302-2	10,12
23322-0	27,32
23392-3	9,12
23402-9	10,12
23422-7	27,32

4. ÜBERGANGSPROFILE/ 4. CONNECTING PROFILES

Andere Eloxalfarben siehe
 Abschnitt 6, Lieferzeit 14 Tage/
 other anodized colours see section
 6, delivery time 14 days

Profi-Pack à 10 Stück im Bund			
professional packing à 10 pcs.			
Farbe/colour	L / l (m)	Art./ref.	€/Stk./pcs.

SB-Pack incl. Schr./ Dübel; VE 20 Stk.	
self-service-pack with screws/ dowels; à 20 pcs.	
Art./ref.	€/Stk./pcs.

06 Stegübergangprofil 28 x 4,5 mm, Aluminium eloxiert, mittig gebohrt

connecting profile with bars
 28 x 4,5 mm, aluminium
 anodized,
 centrally drilled

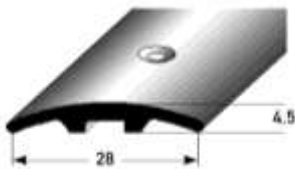

silberfarbig silver	0,9	31205-5	7,74	31207-9	8,62
	1,0	31210-9	8,56	31212-3	9,56
	2,7	31215-4	23,10	31217-8	25,90
goldfarbig gold	0,9	31220-8	7,82	31222-2	8,72
	1,0	31225-3	8,64	31227-7	9,64
	2,7	31230-7	23,42	31232-1	26,16
bronzefarbig hell bronze light	0,9	31235-2	8,06	31237-6	9,42
	1,0	31240-6	8,98	31242-0	10,44
	2,7	31245-1	24,18	31247-5	28,22
bronzefarbig dunkel bronze dark	0,9	31250-5	8,06	31252-9	9,00
	1,0	31255-0	8,98	31257-4	10,00
	2,7	31260-4	24,18	31262-8	26,92

06 Stegübergangprofil 28 x 4,5 mm, Aluminium eloxiert, selbstklebend

connecting profile with bars
 28 x 4,5 mm, aluminium
 anodized,
 self-adhesive

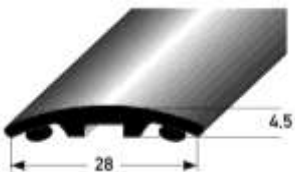

silberfarbig silver	0,9	31206-2	9,78	31208-6	10,36
	1,0	31211-6	10,86	31213-0	11,58
	2,7	31216-1	29,36	31218-5	31,22
goldfarbig gold	0,9	31221-5	9,96	31223-9	10,46
	1,0	31226-0	11,00	31228-4	11,72
	2,7	31231-4	29,66	31233-8	31,46
bronzefarbig hell bronze light	0,9	31236-9	10,12	31238-3	10,78
	1,0	31241-3	11,24	31243-7	11,92
	2,7	31246-8	30,40	31248-2	32,22
bronzefarbig dunkel bronze dark	0,9	31251-2	10,12	31253-6	10,78
	1,0	31256-7	11,24	31258-1	11,92
	2,7	31261-1	30,40	31263-5	32,22

4. ÜBERGANGSPROFILE/ 4. CONNECTING PROFILES

Andere Eloxalfarben siehe
 Abschnitt 6, Lieferzeit 14 Tage/
 other anodized colours see section 6,
 delivery time 14 days

Profi-Pack à 10 Stück im Bund			
professional packing à 10 pcs.			
Farbe/colour	L / l (m)	Art./ref.	€/Stk./pcs.

SB-Pack incl. Schr./ Dübel; VE 20 Stk.	
self-service-pack with screws/ dowels; à 20 pcs.	
Art./ref.	€/Stk./pcs.

07 Übergangprofil 37 x 4,5 mm, Aluminium eloxiert, mittig gebohrt

connecting profile 37 x 4,5 mm,
 aluminium anodized,
 centrally drilled



silberfarbig silver	0,9	31305-2	9,96	31307-6	10,82
	1,0	31310-6	11,02	31312-0	11,98
	2,7	31315-1	29,76	31317-5	32,44
goldfarbig gold	0,9	31320-5	10,16	31322-9	11,12
	1,0	31325-0	11,26	31327-4	12,30
	2,7	31330-4	30,50	31332-8	33,22
bronzefarbig hell bronze light	0,9	31335-9	11,06	31337-3	12,40
	1,0	31340-3	12,26	31342-7	13,80
	2,7	31345-8	33,16	31347-2	37,18
bronzefarbig dunkel bronze dark	0,9	31350-2	11,06	31352-6	11,94
	1,0	31355-7	12,26	31357-1	13,30
	2,7	31360-1	33,16	31362-5	35,90

07 Übergangprofil 37 x 4,5 mm, Aluminium eloxiert, seitlich gebohrt

connecting profile 37 x 4,5 mm,
 aluminium anodized,
 laterally drilled

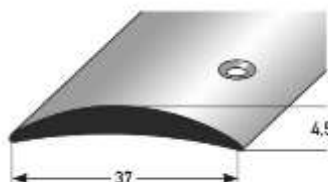

silberfarbig silver	0,9	47700-6	9,96	47706-8	10,82
	1,0	47702-0	11,02	47708-2	11,98
	2,7	47704-4	29,76	47710-5	32,44
goldfarbig gold	0,9	47712-9	10,16	47718-1	11,12
	1,0	47714-3	11,26	47720-4	12,30
	2,7	47716-7	30,50	47722-8	33,22
bronzefarbig hell bronze light	0,9	47724-2	11,06	47730-3	12,40
	1,0	47726-6	12,26	47732-7	13,80
	2,7	47728-0	33,16	47734-1	37,18
bronzefarbig dunkel bronze dark	0,9	47736-5	11,06	47742-6	11,94
	1,0	47738-9	12,26	47744-0	13,30
	2,7	47740-2	33,16	47746-4	35,90

07 Übergangprofil 37 x 4,5 mm, Aluminium eloxiert, selbstklebend

connecting profile 37 x 4,5 mm,
 aluminium anodized,
 self-adhesive



silberfarbig silver	0,9	31306-9	11,96	31308-3	12,56
	1,0	31311-3	13,32	31313-7	13,98
	2,7	31316-8	35,94	31318-2	37,74
goldfarbig gold	0,9	31321-2	12,24	31323-6	12,84
	1,0	31326-7	13,56	31328-1	14,24
	2,7	31331-1	36,70	31333-5	38,50
bronzefarbig hell bronze light	0,9	31336-6	13,14	31338-0	13,72
	1,0	31341-0	14,58	31343-4	15,20
	2,7	31346-5	39,36	31348-9	41,14
bronzefarbig dunkel bronze dark	0,9	31351-9	13,14	31353-3	13,72
	1,0	31356-4	14,58	31358-8	15,20
	2,7	31361-8	39,36	31363-2	41,14

Beispiel: Übergangprofil 37 x 4,5 mm,
 Aluminium (siehe oben)
 example: connecting profile 37 x 4,5 mm,
 aluminium (see above)



4. ÜBERGANGSPROFILE/ 4. CONNECTING PROFILES

Seitlich gebohrt, ungebohrt oder als Flachstreifen auf Anfrage erhältlich!
 Laterally drilled, undrilled or as flat profil available on demand!

**02 Übergangprofil
 37 mm,
 Messing poliert,
 mit Schutzfolie**

connecting profile 37 mm,
 brass polished,
 with protective film



Bitte fordern Sie unsere Pflegehinweise für Messingprofile an!
 Please ask for our care tips for brass profiles!

Profi-Pack à 10 Stück im Bund			
professional packing à 10 pcs.			
Dicke + Befestigung thickness + fixing	L / l (m)	Art./ref.	€/Stk./pcs.
1,0 mm	mittig gebohrt centrally drilled	0,9	06090-1 17,54
		1,0	06100-7 19,52
		2,0	06110-6 39,00
	seitlich gebohrt laterally drilled	0,9	06390-2 17,54
		1,0	06400-8 19,52
		2,7	06420-6 52,66
selbstklebend self-adhesive	0,9	06093-2 19,34	
	1,0	06103-8 21,26	
	2,7	06123-6 60,88	
1,2 mm	mittig gebohrt centrally drilled	0,9	06095-6 19,38
		1,0	06105-2 21,52
		2,7	06125-0 58,14
	seitlich gebohrt laterally drilled	0,9	06094-9 19,38
		1,0	06104-5 21,52
		2,7	06124-3 58,14
	selbstklebend self-adhesive	0,9	06097-0 21,12
		1,0	06107-6 23,30
		2,7	06127-4 62,88

SB-Pack incl. Schr./ Dübel; VE 20 Stk.	
self-service-pack with screws/ dowels; à 20 pcs.	
Art./ref.	€/Stk./pcs.
06091-8	18,68
06101-4	20,68
06121-2	56,20
06391-9	18,68
06401-5	20,68
06421-3	56,20
06092-5	20,14
06102-1	22,14
06122-9	63,52
06096-3	20,52
06106-9	22,68
06126-7	61,64
06099-4	20,52
06109-0	22,68
06129-8	61,64
06098-7	22,02
06108-3	24,14
06128-1	65,46

**15 Übergangprofil
 37 mm,
 Edelstahl poliert,
 mit Schutzfolie**

connecting profile 37 mm,
 stainless steel polished,
 with protective film

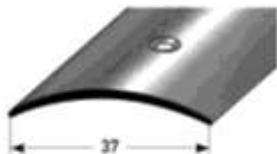

1,0 mm	mittig gebohrt centrally drilled	0,9	06190-8 6,14
		1,0	06200-4 6,82
		2,0	06210-3 13,60
		2,7	06220-2 18,40
	seitlich gebohrt laterally drilled	0,9	06490-9 6,14
		1,0	06500-5 6,82
		2,0	06510-4 13,60
	selbstklebend self-adhesive	2,7	06520-3 18,40
		0,9	06193-9 7,66
1,0		06203-5 8,32	
1,5 mm	mittig gebohrt centrally drilled	2,7	06223-3 22,42
		1,0	42490-1 8,34
	selbstklebend self-adhesive	2,7	42500-7 22,54
1,0		42520-5 9,86	
2,0 mm	mittig gebohrt centrally drilled	2,7	42530-4 26,62
		1,0	42550-2 10,16
	selbstklebend self-adhesive	2,7	42560-1 27,40
		1,0	42580-9 11,72
2,7	42590-8 31,54		

06191-5	7,16
06201-1	7,82
06221-9	21,42
06491-6	7,16
06501-2	7,82
06521-0	21,42
06192-2	8,40
06202-8	9,84
06222-6	25,46
42491-8	9,36
42501-4	25,56
42521-2	10,64
42531-1	29,64
42551-9	11,18
42561-8	30,44
42581-6	12,54
42591-5	33,76

**16 Übergangprofil
 37 mm,
 Edelstahl matt,
 mit Schutzfolie**

connecting profile 37 mm,
 stainless steel matt,
 with protective film

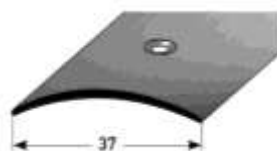

1,0 mm	mittig gebohrt centrally drilled	0,9	06690-3 8,46
		1,0	06700-9 9,40
		2,7	06720-7 25,34
	seitlich gebohrt laterally drilled	0,9	06790-0 8,46
		1,0	06800-6 9,40
		2,7	06820-4 25,34
	selbstklebend self-adhesive	0,9	06890-7 9,98
		1,0	06900-3 10,86
		2,7	06920-1 29,40
1,5 mm	mittig gebohrt centrally drilled	1,0	60025-1 12,56
		2,7	42600-4 34,02
	selbstklebend self-adhesive	1,0	42610-3 14,10
		2,7	42630-1 38,06
2,0 mm	mittig gebohrt centrally drilled	1,0	60545-4 15,84
		2,7	42640-0 42,72
	selbstklebend self-adhesive	1,0	42650-9 17,32
		2,7	42670-7 46,76

06691-0	9,44
06701-6	10,36
06721-4	28,38
06791-7	9,44
06801-3	10,36
06821-1	28,38
06891-4	10,74
06901-0	11,68
06921-8	32,44
42601-1	13,56
42603-5	37,02
42611-0	14,84
42631-8	41,12
42641-7	16,82
42643-1	45,72
42651-6	18,10
42671-4	49,82

4. ÜBERGANGSPROFILE/ 4. CONNECTING PROFILES

Andere Eloxalfarben siehe
 Abschnitt 6, Lieferzeit 14 Tage/
 other anodized colours see section 6,
 delivery time 14 days

Profi-Pack à 10 Stück im Bund			
professional packing à 10 pcs.			
Farbe/colour	L / l (m)	Art./ref.	€/Stk./pcs.

SB-Pack incl. Schr./ Dübel; VE 20 Stk.	
self-service-pack with screws/ dowels; à 20 pcs.	
Art./ref.	€/Stk./pcs.

1 2 Übergangsprofil 38 x 1,8 mm, Aluminium eloxiert, gebohrt

connecting profile 38 x 1,8 mm,
 aluminium anodized,
 drilled

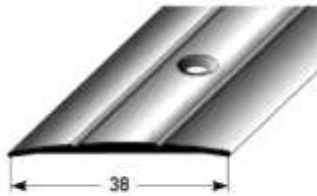

silberfarbig silver	0,9	23490-6	4,86
	1,0	23500-2	5,40
	2,0	23510-1	10,80
	2,7	23520-0	14,58
goldfarbig gold	0,9	23590-3	6,86
	1,0	23600-9	7,64
	2,0	23610-8	15,22
	2,7	23620-7	20,60
bronzefarbig hell bronze light	0,9	23690-0	7,32
	1,0	23700-6	8,16
	2,0	23710-5	16,24
	2,7	23720-4	21,96
bronzefarbig dunkel bronze dark	0,9	23790-7	7,32
	1,0	23800-3	8,16
	2,0	23810-2	16,24
	2,7	23820-1	21,96
edelstahlfarbig Feinschliff fine-honed stainless steel coloured	0,9	71930-4	7,32
	1,0	71932-8	8,16
	2,7	71934-2	21,96
schwarz black	1,0	72094-2	8,16
	2,7	72096-6	21,96

23491-3	5,74
23501-9	6,36
23521-7	17,20
23591-0	7,80
23601-6	8,64
23621-4	23,38
23691-7	8,64
23701-3	9,62
23721-1	25,98
23791-4	8,22
23801-0	9,14
23821-8	24,66
71936-6	8,64
71938-0	9,62
71940-3	25,98
72098-0	9,14
72100-0	24,66

Buche beech	1,0	38340-6	13,02
	2,7	38350-5	35,22
Eiche oak	1,0	38360-4	13,02
	2,7	38370-3	35,22
Ahorn maple	1,0	38380-2	13,02
	2,7	38390-1	35,22
Kirschbaum cherry wood	1,0	38400-7	13,02
	2,7	38405-2	35,22
Eiche rustikal rustic oak	1,0	38410-6	13,02
	2,7	38415-1	35,22

38341-3	14,06
38351-2	38,02
38361-1	14,06
38371-0	38,02
38381-9	14,06
38391-8	38,02
38401-4	14,06
38406-9	38,02
38411-3	14,06
38416-8	38,02

Holzdekorfolie/ wood decor

4. ÜBERGANGSPROFILE/ 4. CONNECTING PROFILES

Andere Eloxalfarben siehe
 Abschnitt 6, Lieferzeit 14 Tage/
 other anodized colours see section 6,
 delivery time 14 days

Profi-Pack à 10 Stück im Bund			
professional packing à 10 pcs.			
Farbe/colour	L / l (m)	Art./ref.	€/Stk./pcs.

SB-Pack incl. Schr./ Dübel; VE 20 Stk.	
self-service-pack with screws/ dowels; à 20 pcs.	
Art./ref.	€/Stk./pcs.

12 Übergangsprofil 38 x 1,8 mm, Aluminium eloxiert, selbstklebend

connecting profile 38 x 1,8 mm,
 aluminium anodized,
 self-adhesive

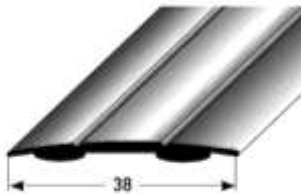

silberfarbig silver	0,9	23493-7	6,84
	1,0	23503-3	7,58
	2,7	23523-1	20,56
goldfarbig gold	0,9	23593-4	8,96
	1,0	23603-0	9,98
	2,7	23623-8	26,82
bronzefarbig hell bronze light	0,9	23693-1	9,40
	1,0	23703-7	10,40
	2,7	23723-5	28,16
bronzefarbig dunkel bronze dark	0,9	23793-8	9,40
	1,0	23803-4	10,40
	2,7	23823-2	28,16
edelstahlfarbig Feinschliff fine-honed stainless steel coloured	0,9	71942-7	9,40
	1,0	71944-1	10,40
	2,7	71946-5	28,16
schwarz black	1,0	72102-4	10,40
	2,7	72104-8	28,16

23492-0	7,46
23502-6	8,24
23522-4	22,42
23592-7	9,54
23602-3	10,62
23622-1	28,64
23692-4	10,02
23702-0	11,14
23722-8	29,94
23792-1	10,02
23802-7	11,14
23822-5	29,94
71948-9	10,02
68004-8	11,14
68006-2	29,94
72106-2	11,14
72108-6	29,94

Holzdekorfolie/ wood decor	Buche beech	1,0	38280-5	15,76
		2,7	38290-4	42,52
	Eiche oak	1,0	38300-0	15,76
		2,7	38310-9	42,52
	Ahorn maple	1,0	38320-8	15,76
		2,7	38330-7	42,52
	Kirschbaum cherry wood	1,0	38420-5	15,76
		2,7	38425-0	42,52
	Eiche rustikal rustic oak	1,0	38430-4	15,76
		2,7	38435-9	42,52

38281-2	16,42
38291-1	44,30
38301-7	16,42
38311-6	44,30
38321-5	16,42
38331-4	44,30
38421-2	16,42
38426-7	44,30
38431-1	16,42
38436-6	44,30

4. ÜBERGANGSPROFILE/ 4. CONNECTING PROFILES

Andere Eloxalfarben siehe
 Abschnitt 6, Lieferzeit 14 Tage/
 other anodized colours see section 6,
 delivery time 14 days

Profi-Pack à 10 Stück im Bund			
professional packing à 10 pcs.			
Befestigung/ fixing	L / l (m)	Art./ref.	€/Stk./pcs.

SB-Pack incl. Schr./ Dübel; VE 20 Stk.	
self-service-pack with screws/ dowels; à 20 pcs.	
Art./ref.	€/Stk./pcs.

03 Übergangsprofil 48 x 2 mm, Messing poliert

connecting profile 48 x 2 mm, brass polished



mittig gebohrt centrally drilled	1,0	28761-2	50,18	28763-6	51,60
	2,5	28760-5	125,44		
seitlich gebohrt laterally drilled	1,0	48060-0	50,18	48064-8	51,60
	2,5	48062-4	125,44		
selbstklebend self-adhesive	1,0	48070-9	52,68	48074-7	53,82
	2,5	48072-3	131,68		

28762-9	128,98
48066-2	128,98
48076-1	134,68

Bitte fordern Sie unsere Pflegehinweise für Messingprofile an!
 Please ask for our care tips for brass profiles!

155 Übergangsprofil 50 x 1,5 mm, Edelstahl matt, gewölbt

connecting profile 50 x 1,5 mm, stainless steel matt, curved

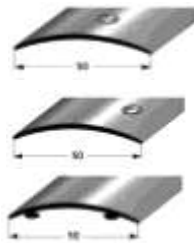

mittig gebohrt centrally drilled	1,0	63000-5	28,64	63010-4	31,40
	2,7	63005-0	77,34		
seitlich gebohrt laterally drilled	1,0	63020-3	28,64	63030-2	31,40
	2,7	63025-8	77,34		
selbstklebend self-adhesive	1,0	63040-1	31,02	63050-0	33,76
	2,7	63045-6	77,62		

63015-9	79,80
63035-7	79,80
63055-5	85,82

145 Übergangsprofil 50 x 4 mm, Aluminium eloxiert, mittig gebohrt, für starke Belastungen

connecting profile 50 x 4 mm,
 aluminium anodized, heavy duty,
 centrally drilled



Farbe/colour					
silberfarbig silver	1,0	42820-6	15,12	42830-5	16,16
	2,7	42825-1	40,92		
goldfarbig gold	1,0	42840-4	15,68	42850-3	16,72
	2,7	42845-9	42,30		
bronzef. hell bronze light	1,0	42860-2	16,74	42870-1	18,18
	2,7	42865-7	45,04		
bronzef. dunkel bronze dark	1,0	42880-0	16,74	42890-9	17,74
	2,7	42885-5	45,04		

42835-0	43,70
42855-8	44,98
42875-6	49,14
42895-4	47,78

145 Übergangsprofil 50 x 4 mm, Aluminium eloxiert, seitlich gebohrt, für starke Belastungen

connecting profile 50 x 4 mm,
 aluminium anodized, heavy duty,
 laterally drilled

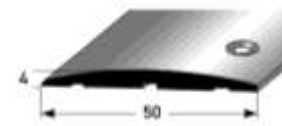

silberfarbig silver	1,0	47818-8	15,12	47822-5	16,16
	2,7	47820-1	40,92		
goldfarbig gold	1,0	47826-3	15,68	47830-0	16,72
	2,7	47828-7	42,30		
bronzef. hell bronze light	1,0	47834-8	16,74	47838-6	18,18
	2,7	47836-2	45,04		
bronzef. dunkel bronze dark	1,0	47842-3	16,74	47846-1	17,74
	2,7	47844-7	45,04		

47832-4	44,98
47840-9	49,14
47848-5	47,78

145 Übergangsprofil 50 x 4 mm, Aluminium eloxiert, selbstklebend, für starke Belastungen

connecting profile 50 x 4 mm,
 aluminium anodized, heavy duty,
 self-adhesive



silberfarbig silver	1,0	47750-1	17,40	47754-9	18,10
	2,7	47752-5	47,12		
goldfarbig gold	1,0	47758-7	18,00	47762-4	18,60
	2,7	47760-0	48,50		
bronzef. hell bronze light	1,0	47766-2	19,02	47770-9	20,14
	2,7	47768-6	51,30		
bronzef. dunkel bronze dark	1,0	47774-7	19,02	47778-5	20,14
	2,7	47776-1	51,30		

47764-8	50,22
47772-3	54,36
47780-8	54,36

4. ÜBERGANGSPROFILE/ 4. CONNECTING PROFILES

Andere Eloxalfarben siehe
Abschnitt 6, Lieferzeit 14 Tage/
other anodized colours see section 6,
delivery time 14 days

Profi-Pack à 10 Stück im Bund			
professional packing à 10 pcs.			
Befestigung/ fixing	L / l (m)	Art./ref.	€/Stk./pcs.

SB-Pack incl. Schr./ Dübel; VE 20 Stk./	
self-service-pack with screws/ dowels; à 20 pcs.	
Art./ref.	€/Stk./pcs.

04 Übergangprofil 57 x 2 mm, Messing poliert

connecting profile 57 x 2 mm, brass polished

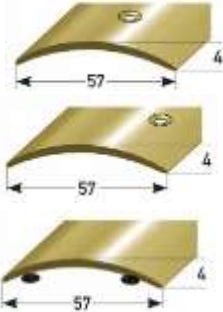

mittig gebohrt centrally drilled	1,0	28771-1	53,84	28773-5	55,24
	2,5	28770-4	134,60		

seitlich gebohrt laterally drilled	1,0	48080-8	53,84	48084-6	55,24
	2,5	48082-2	134,60		

selbstklebend self-adhesive	1,0	48090-7	56,38	48094-5	57,48
	2,5	48092-1	141,02		

Bitte fordern Sie unsere Pflegehinweise für Messingprofile an!
Please ask for our care tips for brass profiles!

08 Übergangprofil 58 x 4 mm, Aluminium eloxiert, mittig gebohrt, für starke Belastungen

connecting profile 58 x 4 mm,
aluminium anodized, heavy duty,
centrally drilled



Farbe/colour					
silberfarbig silver	1,0	31600-8	17,44	31601-5	18,44
	2,7	31605-3	47,14		
goldfarbig gold	1,0	31610-7	18,06	31611-4	19,10
	2,7	31615-2	48,78		
bronzef. hell bronze light	1,0	31620-6	19,32	31621-3	20,76
	2,7	31625-1	52,04		
bronzef. dunkel bronze dark	1,0	31630-5	19,32	31631-2	20,32
	2,7	31635-0	52,04		

31601-5	18,44
31606-0	49,86
31611-4	19,10
31616-9	51,44
31621-3	20,76
31626-8	56,04
31631-2	20,32
31636-7	54,78

08 Übergangprofil 58 x 4 mm, Aluminium eloxiert, seitlich gebohrt, für starke Belastungen

connecting profile 58 x 4 mm,
aluminium anodized, heavy duty,
laterally drilled



silberfarbig silver	1,0	47852-2	17,44	47856-0	18,44
	2,7	47854-6	47,14		
goldfarbig gold	1,0	47860-7	18,06	47864-5	19,10
	2,7	47862-1	48,78		
bronzef. hell bronze light	1,0	47868-3	19,32	47872-0	20,76
	2,7	47870-6	52,04		
bronzef. dunkel bronze dark	1,0	47876-8	19,32	47880-5	20,32
	2,7	47878-2	52,04		

47856-0	18,44
47858-4	49,86
47864-5	19,10
47866-9	51,44
47872-0	20,76
47874-4	56,04
47880-5	20,32
47882-9	54,78

08 Übergangprofil 58 x 4 mm, Aluminium eloxiert, selbstklebend, für starke Belastungen

connecting profile 58 x 4 mm,
aluminium anodized, heavy duty,
self-adhesive



silberfarbig silver	1,0	47784-6	21,70	47788-4	21,96
	2,7	47786-0	58,56		
goldfarbig gold	1,0	47792-1	22,32	47796-9	22,58
	2,7	47794-5	60,22		
bronzef. hell bronze light	1,0	47800-3	23,54	47804-1	24,20
	2,7	47802-7	63,50		
bronzef. dunkel bronze dark	1,0	47808-9	23,54	47812-6	24,20
	2,7	47810-2	63,50		

47788-4	21,96
47790-7	59,36
47796-9	22,58
47798-3	60,94
47804-1	24,20
47806-5	65,54
47812-6	24,20
47814-0	65,54

4. ÜBERGANGSPROFILE/ 4. CONNECTING PROFILES

Andere Eloxalfarben siehe
 Abschnitt 6, Lieferzeit 14 Tage/
 other anodized colours see section 6,
 delivery time 14 days

Profi-Pack à 10 Stück im Bund			
professional packing à 10 pcs.			
Farbe/colour	L / l (m)	Art./ref.	€/Stk./pcs.

SB-Pack incl. Schr./ Dübel; VE 20 Stk.	
self-service-pack with screws/ dowels; à 20 pcs.	
Art./ref.	€/Stk./pcs.

350 Übergangprofil 80 x 3,5 mm, Aluminium eloxiert, mittig gebohrt

connecting profile 80 x 3,5 mm,
 aluminium anodized,
 centrally drilled

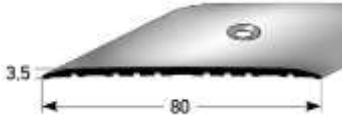

silberfarbig silver	1,0	65400-1	20,40
	2,7	65402-5	55,06
goldfarbig gold	1,0	65404-9	20,82
	2,7	65406-3	56,22
bronzef. hell bronze light	1,0	65408-7	23,10
	2,7	65410-0	62,40
bronzef. dunkel bronze dark	1,0	65412-4	23,10
	2,7	65414-8	62,40

65416-2	21,38
65418-6	58,00
65420-9	21,80
65422-3	59,14
65424-7	24,08
65426-1	65,32
65428-5	24,08
65430-8	65,32

350 Übergangprofil 80 x 3,5 mm, Aluminium eloxiert, seitlich gebohrt

connecting profile 80 x 3,5 mm,
 aluminium anodized,
 laterally drilled

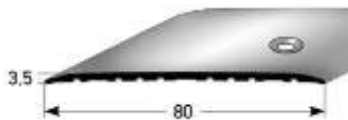

silberfarbig silver	1,0	65434-6	20,40
	2,7	65436-0	55,06
goldfarbig gold	1,0	65438-4	20,82
	2,7	65440-7	56,22
bronzef. hell bronze light	1,0	65442-1	23,10
	2,7	65444-5	62,40
bronzef. dunkel bronze dark	1,0	65446-9	23,10
	2,7	65448-3	62,40

65450-6	21,38
65452-0	58,00
65454-4	21,80
65456-8	59,14
65458-2	24,08
65460-5	65,32
65462-9	24,08
65464-3	65,32

350 Übergangprofil 80 x 3,5 mm, Aluminium eloxiert, selbstklebend

connecting profile 80 x 3,5 mm,
 aluminium anodized,
 self-adhesive

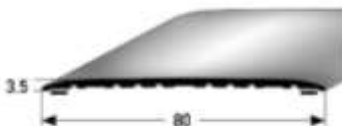

silberfarbig silver	1,0	65468-1	24,48
	2,7	65470-4	66,10
goldfarbig gold	1,0	65472-8	24,96
	2,7	65474-2	67,38
bronzef. hell bronze light	1,0	65476-6	27,22
	2,7	65478-0	73,50
bronzef. dunkel bronze dark	1,0	65480-3	27,22
	2,7	65482-7	73,50

65484-1	25,22
65486-5	68,12
65488-9	25,70
65490-2	69,38
65492-6	27,96
65494-0	75,50
65496-4	27,96
65498-8	75,50



Profi-Pack à 10 Stück im Bund			
professional packing à 10 pcs.			
Befestigung/ fixing	L / l (m)	Art./ref.	€/Stk./pcs.

SB-Pack incl. Schr./ Dübel; VE 20 Stk.	
self-service-pack with screws/ dowels; à 20 pcs.	
Art./ref.	€/Stk./pcs.

585 Übergangprofil 100 x 3,5 mm, Aluminium silber eloxiert

connecting profile 100 x 3,5 mm, aluminium silver anodized



mittig gebohrt centrally drilled	2,7	72978-5	74,16
-------------------------------------	-----	---------	-------

72986-0	77,08
---------	-------

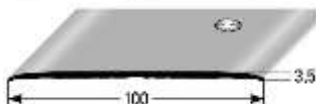

seitlich gebohrt laterally drilled	2,7	72980-8	74,16
---------------------------------------	-----	---------	-------

72988-4	77,08
---------	-------



selbstklebend self-adhesive	2,7	72982-2	85,18
--------------------------------	-----	---------	-------

72990-7	87,20
---------	-------

4. ÜBERGANGSPROFILE/ 4. CONNECTING PROFILES

Profi-Pack à 10 Stück im Bund				SB-Pack incl. Schr./ Dübel; VE 20 Stk.	
professional packing à 10 pcs.				self-service-pack with screws/ dowels; à 20 pcs.	
Befestigung/fixing	L / l (m)	Art./ref.	€/Stk./pcs.	Art./ref.	€/Stk./pcs.

439 Edelstahl-Übergangprofil 27 x 1,5 mm, profilierte Riffelung, matt

stainless steel connecting profile 27 x 1,8 mm, fluted profile, matt

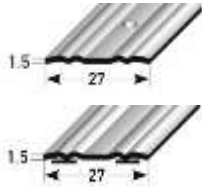

mittig gebohrt centrally drilled	1,0	68270-7	12,26	68282-0	13,26
	2,7	68272-1	33,14	68284-4	35,84
selbstklebend self-adhesive	1,0	68276-9	14,10	68288-2	14,84
	2,7	68278-3	38,10	68290-5	40,80

440 Edelstahl-Übergangprofil 38 x 1,5 mm, profilierte Riffelung, matt

stainless steel connecting profile 38 x 1,8 mm, fluted profile, matt

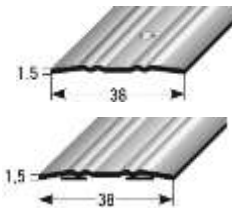

mittig gebohrt centrally drilled	1,0	68300-1	15,06	68312-4	16,06
	2,7	68302-5	40,72	68314-8	43,42
selbstklebend self-adhesive	1,0	68306-3	16,94	68318-6	17,66
	2,7	68308-7	45,70	68320-9	47,70

441 Übergangprofil 30 x 3,5 mm, Edelstahl V4A gezogen, gebohrt

drawn stainless steel connecting profile V4A 30 x 3,5 mm, drilled



mittig gebohrt centrally drilled	1,0	68330-8	88,66	68336-0	91,30
	2,5	68332-2	221,66	68338-4	229,60

Edelstahlschrauben siehe
Abschnitt 12/
stainless steel screws see
section 12

Edelstahl-Übergangprofile INOX PROTECT zur Verlegung mit Einlage 39 mm			
stainless steel connecting profiles for installation with insert 39 mm			
L / l (m)	VE/unit	Art./ref.	€/Stk./pcs.

412 Übergangprofil 70 x 1,5 mm INOX PROTECT, Edelstahl matt, gebohrt

connecting profile INOX
PROTECT 70 x 1,5 mm,
stainless steel matt, drilled



1,0 m	1 Stück/pcs.	67034-6	40,10
2,5 m		67036-0	100,20
3,0 m*		67038-4	120,30

für Verlegung mit Einlage 39 mm, siehe Seite 23
for installation with insert 39 mm, see page 23



Übergangprofil INOX PROTECT mit Einlage 39 mm,
Easy-Clean, gelb-schwarz (siehe oben bzw. Seite 23)
connecting profile INOX PROTECT with insert 39 mm,
Easy-Clean, yellow-black (see above and page 23)

* 3,0 m-Ware ist nur per Spedition lieferbar
(gesonderte Transportkosten)
3,0 m profiles are only available per forwarding agency
(separate transport costs)

4. ÜBERGANGSPROFILE/ 4. CONNECTING PROFILES

Andere Abmaße auf Anfrage/ other dimensions on demand

gekantete Übergangprofile aus mattem Edelstahl					
edged connecting profiles, stainless steel matt					
Breite/ width (mm)	L / l (m)	1,5 mm		2,0 mm	
		Materialstärke/ thickness		Materialstärke/ thickness	
		Art./ref.	€/Stk./pcs.	Art./ref.	€/Stk./pcs.

Übergangspr. 1,5 / 2,0 / 3,0 mm, Edelstahl matt, gekantet 250

136

connecting profile
 1,5/ 2,0/ 3,0 mm,
 stainless steel matt, edged

50 mm	1,00	60045-9	27,20	60560-7	36,32
	1,25	60050-3	34,10	60565-2	45,38
	2,50	60060-2	68,04	60570-6	90,76

Bitte Befestigungstyp angeben:

- 01 mittig gebohrt
- 02 seitlich gebohrt
- 03 wechselseitig seitlich
- 04 ungebohrt
- 05 selbstklebend

60 mm	1,00	60065-7	32,66	60575-1	43,46
	1,25	60070-1	40,82	60580-5	54,44
	2,50	60080-0	81,56	60585-0	108,78

70 mm	1,00	60085-5	38,10	60590-4	50,76
	1,25	60090-9	47,64	60595-9	63,52
	2,50	60100-5	95,20	60600-0	126,92

Please specify fixing:

- 01 drilled centrally
- 02 drilled laterally
- 03 alternating sides drilled
- 04 undrilled
- 05 self adhesive

80 mm	1,00	60105-0	43,52	60605-5	58,04
	1,25	60110-4	54,46	60610-9	72,56
	2,50	60120-3	108,80	60615-4	145,04

100 mm	1,00	60125-8	54,44	60620-8	72,56
	1,25	60130-2	68,00	60625-3	90,70
	2,50	60140-1	136,00	60630-7	181,36

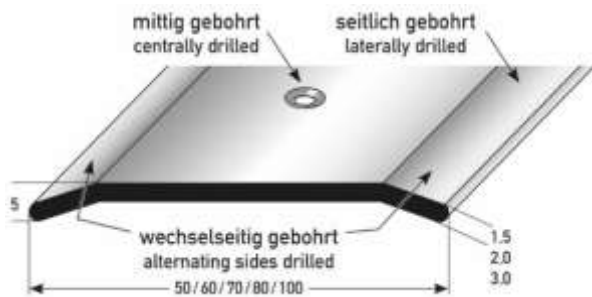

237

Breite/ width (mm)	L / l (m)	3,0 mm	
		Art./ref.	€/Stk./pcs.
60 mm	1,00	60700-7	65,26
	1,25	60705-2	81,56
	2,50	60710-6	163,18

238

70 mm	1,00	60715-1	76,16
	1,25	60720-5	95,22
	2,50	60725-0	190,40

239

80 mm	1,00	60730-4	87,02
	1,25	60735-9	108,80
	2,50	60740-3	217,60

240

100 mm	1,00	60745-8	108,80
	1,25	60750-2	136,02
	2,50	60755-7	272,06

Bohrungen bis 2 mm Stärke für 3,5 mm Schrauben;
Bohrungen bei 3 mm Stärke für 4 mm Schrauben
 holes up to 2 mm thickness for 3.5 mm screws;
 drilling at 3 mm for 4 mm screws

Edelstahlschrauben siehe Abschnitt 12/
 stainless steel screws see section 12

4. ÜBERGANGSPROFILE/ 4. CONNECTING PROFILES

Andere Abmaße auf Anfrage/ other dimensions on demand

Aluminium-Flachschwellen								
aluminium flat thresholds								
Breite/ width A (mm)	Farbe/colour		AxB mm	L / l (m)	gebohrt/ drilled	€/m	ohne alles/ bare	€/m

Flachschwellen 1,5 / 2,0 / 3,0 / 5,0 mm, Aluminium

flat threshold
1,5/ 2,0/ 3,0/
5,0 mm, aluminium



Seitlich oder wechselseitig gebohrt auf Anfrage
Laterally or alternately drilled on request

* inklusive 40 mm Klemmstelle an einer Seite vom Eloxieren/ including 40 mm clamping point on one side by anodizing

40 mm	silber elox. silver anodized	457	40 x 1,0	2,5	68744-3	7,92/m	68752-8	6,06/m		
		538	40 x 2,0	2,5	68746-7	14,00/m	68754-2	12,18/m		
		539	40 x 3,0	2,5*	68748-1	20,12/m	68756-6	18,26/m		
	edelstahl- farbig stainless steel coloured		40 x 1,0	2,5*	68768-9	10,28/m	68776-4	8,46/m		
			40 x 2,0	2,5*	68770-2	16,38/m	68778-8	14,52/m		
			40 x 3,0	2,5*	68772-6	22,48/m	68780-1	20,66/m		
50 mm	silber elox. silver anodized	458	50 x 1,0	2,5	68816-7	9,44/m	68824-2	7,60/m		
		540	50 x 2,0	2,5	68818-1	17,08/m	68826-6	15,22/m		
		541	50 x 3,0	2,5*	68820-4	24,14/m	68828-0	22,32/m		
	edelstahl- farbig stainless steel coloured		50 x 1,0	2,5*	68840-2	11,54/m	68848-8	9,70/m		
			50 x 2,0	2,5*	68842-6	19,42/m	68850-1	17,60/m		
			50 x 3,0	2,5*	68844-0	26,46/m	68852-5	24,64/m		
60 mm	silber elox. silver anodized	298	60 x 1,0	2,5	61924-6	11,38/m	61930-7	9,76/m		
		428	60 x 2,0	2,5	67246-3	18,14/m	67252-4	15,40/m		
		299	60 x 3,0	2,5*	61944-4	25,38/m	61950-5	23,70/m		
		300	60 x 5,0	3,0*	61964-2	38,96/m	61970-3	37,26/m		
	edelstahl- farbig stainless steel coloured		60 x 1,0	2,5*	61926-0	13,52/m	61932-1	11,84/m		
			60 x 2,0	2,5*	67248-7	23,38/m	67254-8	21,76/m		
			60 x 3,0	2,5*	61946-8	27,52/m	61952-9	25,84/m		
			60 x 5,0	3,0*	61966-6	41,06/m	61972-7	39,40/m		
		80 mm	silber elox. silver anodized	542	80 x 1,0	2,5	68888-4	14,00/m	68896-9	12,18/m
				543	80 x 2,0	2,5	68890-7	26,20/m	68898-3	24,38/m
544	80 x 3,0			2,5*	68892-1	38,38/m	68900-3	36,54/m		
edelstahl- farbig stainless steel coloured			80 x 1,0	2,5*	68912-6	17,16/m	68920-1	15,34/m		
			80 x 2,0	2,5*	68914-0	29,36/m	68922-5	27,52/m		
			80 x 3,0	2,5*	68916-4	41,54/m	68924-9	39,64/m		
100 mm	silber elox. silver anodized	545	100 x 1,0	2,5	68960-7	17,08/m	68968-3	15,22/m		
		546	100 x 2,0	2,5	68962-1	32,26/m	68970-6	30,44/m		
		547	100 x 3,0	2,5*	68964-5	47,52/m	68972-0	45,66/m		
	edelstahl- farbig stainless steel coloured		100 x 1,0	2,5*	68984-3	20,98/m	68992-8	19,16/m		
			100 x 2,0	2,5*	68986-7	36,22/m	68994-2	34,38/m		
			100 x 3,0	2,5*	68988-1	51,42/m	68996-6	49,60/m		

3,0 m-Ware ist nur per Spedition lieferbar (gesonderte Transportkosten)

3,0 m profiles are only available per forwarding agency (separate transport costs)

4. ÜBERGANGSPROFILE/ 4. CONNECTING PROFILES

Andere Abmaße auf Anfrage/ other dimensions on demand

Flachprofile/ Flachswellen aus mattem Edelstahl						
flat thresholds out of stainless steel matt						
Breite/ width A (mm)	L / l (m)	B = 1,0 mm Materialstärke/ thickness			B = 1,5 mm Materialstärke/ thickness	
		Koffernr. case no.	Art./ref.	€/Stk./pcs.	Koffernr. case no.	Art./ref.

413 Flachprofil/ Flachschwelle 1,0 / 1,5 / 2,0 / 3,0 / 5,0 mm, **Edelstahl matt**

flat threshold
1,0/ 1,5/ 2,0/ 3,0/ 5,0 mm,
stainless steel matt

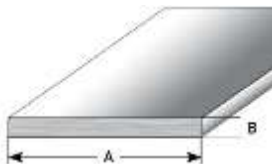

Bitte Befestigungstyp angeben:

- 01 mittig gebohrt
 - 02 seitlich gebohrt
 - 03 wechselseitig seitlich
 - 04 ungebohrt
 - 05 selbstklebend
- Please specify fixing:**
- 01 drilled centrally
 - 02 drilled laterally
 - 03 alternating sides drilled
 - 04 undrilled
 - 05 self adhesive

30 mm	1,00	548	72648-7	9,60	549	72660-9	13,88
	2,50		72650-0	24,00		72662-3	34,66
35 mm	1,00	550	72652-4	11,20	551	72664-7	15,94
	2,50		72654-8	28,00		72666-1	29,10
40 mm	1,00	442	68350-6	12,32	443	68362-9	18,54
	2,50		68352-0	30,82		68364-3	46,26
45 mm	1,00	552	72656-2	14,40	553	72668-5	19,66
	2,50		72658-6	35,98		72670-8	49,16
50 mm	1,00	285	67420-7	16,52	288	67442-9	20,80
	2,50		61892-8	41,58		61906-2	52,00
60 mm	1,00	286	67422-1	20,52	289	67444-3	24,96
	2,50		61894-2	51,32		61908-6	62,40
70 mm	1,00	414	67424-5	22,94	416	67446-7	29,10
	2,50		67426-9	57,24		67448-1	72,80
80 mm	1,00	287	67428-3	25,80	290	67450-4	33,26
	2,50		61896-6	64,54		61910-9	83,16
100 mm	1,00	415	67430-6	32,72	291	67452-8	41,60
	2,50		67432-0	81,86		61912-3	103,96

Breite/ width A (mm)	L / l (m)	B = 2,0 mm Materialstärke/ thickness			B = 3,0 mm Materialstärke/ thickness		
		Koffernr. case no.	Art./ref.	€/Stk./pcs.	Koffernr. case no.	Art./ref.	€/Stk./pcs.
30 mm	1,00	554	72672-2	18,40	555	72684-5	25,98
	2,50		72674-6	45,98		72686-9	64,98
35 mm	1,00	556	72676-0	21,32	557	72688-3	30,32
	2,50		72678-4	53,64		72690-6	75,82
40 mm	1,00	444	68374-2	24,66	445	68386-5	37,00
	2,50		68376-6	61,70		68388-9	92,52
45 mm	1,00	558	72680-7	26,20	559	72692-0	39,00
	2,50		72682-1	65,48		72694-4	97,50
50 mm	1,00	417	67464-1	27,72	422	67496-2	41,60
	2,50		67466-5	69,32		67498-6	103,96
60 mm	1,00	418	67468-9	33,26	423	67500-6	49,90
	2,50		67470-2	83,16		67502-0	124,76
70 mm	1,00	419	67472-6	38,82	424	67504-4	58,22
	2,50		67474-0	97,02		67506-8	145,54
80 mm	1,00	420	67476-4	44,38	425	67508-2	66,54
	2,50		67478-8	110,92		67510-5	166,34
100 mm	1,00	421	67480-1	55,44	426	67512-9	83,16
	2,50		67482-5	138,62		67514-3	207,94

Bohrungen bis 2 mm Stärke für 3,5 mm Schrauben;
Bohrungen bei 3 - 5 mm Stärke für 4 mm Schrauben
holes up to 2 mm thickness for 3.5 mm screws;
drilling at 3 - 5 mm for 4 mm screws

Edelstahlschrauben siehe Abschnitt 12/ stainless steel screws see section 12

4. ÜBERGANGSPROFILE/ 4. CONNECTING PROFILES

Andere Abmaße auf Anfrage/

other dimensions on demand

413 Flachprofil/ Flachschielle 5,0 mm, Edelstahl matt

flat threshold 5,0 mm, stainless steel matt

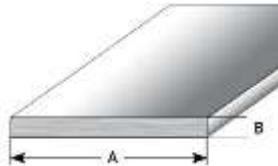

Bohrungen bei 3 - 5 mm

Stärke für 4 mm Schrauben

drilling at 3 - 5 mm for 4 mm screws

Flachprofile/ Flachschiellen aus mattem Edelstahl				
flat threshold out of stainless steel matt				
Breite/ width A (mm)	L / l (m)	B = 5,0 mm Materialstärke/ thickness		
		Koffernr. case no.	Art./ref.	€/Stk./pcs.

30 mm	1,00	560	72596-1	52,00
	2,50		72598-5	129,98
35 mm	1,00	561	72600-5	60,66
	2,50		72602-9	151,62
40 mm	1,00	562	72604-3	69,32
	2,50		72606-7	173,30
45 mm	1,00	563	72608-1	77,98
	2,50		72610-4	194,96
50 mm	1,00	564	72612-8	86,64
	2,50		72614-2	216,62
60 mm	1,00	565	72616-6	103,98
	2,50		72618-0	259,94

Bitte Befestigungstyp angeben:

- 01 mittig gebohrt
- 02 seitlich gebohrt
- 03 wechselseitig seitlich
- 04 ungebohrt
- 05 selbstklebend

Please specify fixing:

- 01 drilled centrally
- 02 drilled laterally
- 03 alternating sides drilled
- 04 undrilled
- 05 self adhesive

Andere Abmaße auf Anfrage/

other dimensions on demand

Verbundschwelle, ungebohrt/ composite threshold undrilled

Deckprofil Edelstahl matt verklebt mit Grundkonstruktion Aluminium pressblank

cover profile out of matt stainless steel glued to basic construction aluminium mill finish



Verbundschwellen Edelstahl - Aluminium					
composite threshold stainless steel - aluminium					
Breite/ width A (mm)	L / l (m)	B = 5,0 mm Materialstärke/ thickness		B = 8,0 mm Materialstärke/ thickness	
		Art./ref.	€/Stk./pcs.	Art./ref.	€/Stk./pcs.

566

567

568

40 mm	1,00	72622-7	45,98	72626-5	56,22
	2,50	72624-1	114,98	72628-9	140,52
50 mm	1,00	72630-2	51,62	72634-0	64,38
	2,50	72632-6	129,04	72636-4	160,96
60 mm	1,00	72638-8	59,70	72642-5	75,02
	2,50	72640-1	149,26	72644-9	187,60

Lieferzeit nach Absprache

delivery time after consultation

Andere Befestigungstypen (gebohrt, selbstklebend,...), sowie ausgeklinkte Version auf Anfrage erhältlich.

Other fastening types (drilled, self-adhesive,...), as well as notched version available on request.

4. ÜBERGANGSPROFILE/ 4. CONNECTING PROFILES

Andere Eloxalfarben siehe
Abschnitt 6, Lieferzeit 14 Tage/
other anodized colours see
section 6, delivery time 14 days

Profi-Pack à 10 Stück im Bund			
professional packing à 10 pcs.			
Farbe/colour	L / l (m)	Art./ref.	€/Stk./pcs.

SB-Pack incl. Schr./ Dübel; VE 20 Stk.	
self-service-pack with screws/ dowels; à 20 pcs.	
Art./ref.	€/Stk./pcs.

09 Abschlussprofil 30 x 4,5 mm, Aluminium eloxiert, gebohrt

adaptation profile 30 x 4,5 mm,
aluminium anodized,
drilled

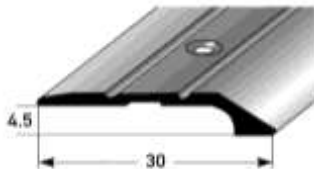

silberfarbig silver	0,9	08090-9	6,84
	1,0	08100-5	7,64
	2,7	08110-4	20,54
goldfarbig gold	0,9	08190-6	6,94
	1,0	08200-2	7,78
	2,7	08210-1	20,96
bronzef. hell bronze light	0,9	08290-3	7,24
	1,0	08300-9	8,04
	2,7	08310-8	21,70
bronzef. dunkel bronze dark	0,9	08390-0	7,24
	1,0	08400-6	8,04
	2,7	08410-5	21,70

08091-6	7,78
08101-2	8,62
08111-1	23,32
08191-3	7,86
08201-9	8,74
08211-8	23,64
08291-0	8,56
08301-6	9,50
08311-5	25,74
08391-7	8,16
08401-3	9,02
08411-2	24,38

09 Abschlussprofil 30 x 4,5 mm, Aluminium eloxiert, selbstklebend

adaptation profile 30 x 4,5 mm,
aluminium anodized,
self-adhesive



silberfarbig silver	0,9	08093-0	8,96
	1,0	08103-6	9,96
	2,7	08113-5	26,76
goldfarbig gold	0,9	08193-7	9,06
	1,0	08203-3	10,06
	2,7	08213-2	27,20
bronzef. hell bronze light	0,9	08293-4	9,26
	1,0	08303-0	10,32
	2,7	08313-9	27,86
bronzef. dunkel bronze dark	0,9	08393-1	9,26
	1,0	08403-7	10,32
	2,7	08413-6	27,86

08092-3	9,50
08102-9	10,52
08112-8	28,52
08192-0	9,62
08202-6	10,76
08212-5	28,96
08292-7	9,96
08302-3	11,00
08312-2	29,66
08392-4	9,96
08402-0	11,00
08412-9	29,66

349 Anpassungsprofil 40 mm, Höhengleichung 2 bis 16 mm, Aluminium eloxiert, gebohrt

levelling profile 40 mm,
height compensation 2-16 mm,
aluminium anodized,
drilled



silberfarbig silver	1,0	66116-0	10,96
	2,7	66118-4	29,56
goldfarbig gold	1,0	66120-7	11,24
	2,7	66122-1	30,38
bronzef. hell bronze light	1,0	66124-5	12,24
	2,7	66126-9	33,06
bronzef. dunkel bronze dark	1,0	66128-3	12,24
	2,7	66130-6	33,06

66136-8	11,92
66138-2	32,56
66140-5	12,24
66142-9	33,34
66144-3	13,72
66146-7	37,54
66148-1	13,24
66150-4	36,00

349 Anpassungsprofil 40 mm, Höhengleichung 2 bis 16 mm, Aluminium elox., selbstklebend

levelling profile 40 mm,
height compensation 2-16 mm,
aluminium anodized,
self-adhesive

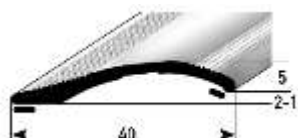

silberfarbig silver	1,0	66158-0	13,22
	2,7	66160-3	35,66
goldfarbig gold	1,0	66162-7	13,52
	2,7	66164-1	36,42
bronzef. hell bronze light	1,0	66166-5	14,50
	2,7	66168-9	39,14
bronzef. dunkel bronze dark	1,0	66170-2	14,50
	2,7	66172-6	39,14

66178-8	13,80
66180-1	37,46
66182-5	14,10
66184-9	38,22
66186-3	15,10
66188-7	40,96
66190-0	15,10
66192-4	40,96

4. ÜBERGANGSPROFILE/ 4. CONNECTING PROFILES

Andere Eloxalfarben siehe
Abschnitt 6, Lieferzeit 14 Tage/
other anodized colours see section 6,
delivery time 14 days

Profi-Pack à 10 Stück im Bund			
professional packing à 10 pcs.			
Farbe/colour	L / l (m)	Art./ref.	€/Stk./pcs.

SB-Pack incl. Schr./ Dübel; VE 20 Stk.	
self-service-pack with screws/ dowels; à 20 pcs.	
Art./ref.	€/Stk./pcs.

132 Abschlussprofil für Laminat, 34 x 8,5 mm, Aluminium eloxiert, gebohrt

adaptation profile for laminate,
34 x 8,5 mm, aluminium
anodized, drilled

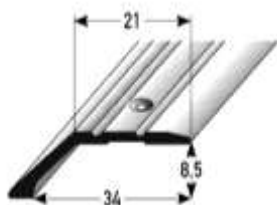

silberfarbig silver	1,0	41580-0	10,00	41581-7	11,02
	2,7	41590-9	26,86		
goldfarbig gold	1,0	41600-5	10,26	41601-2	11,26
	2,7	41610-4	27,70		
bronzef. hell bronze light	1,0	41620-3	11,16	41621-0	12,66
	2,7	41630-2	30,06		
bronzef. dunkel bronze dark	1,0	41640-1	11,16	41641-8	12,18
	2,7	41650-0	30,06		
gold hell gold light	1,0	62245-1	10,26	62255-0	11,26
	2,7	62250-5	27,70		
				62260-4	30,50

132 Abschlussprofil für Laminat, 34 x 8,5 mm, Aluminium eloxiert, selbstklebend

adaptation profile for laminate,
34 x 8,5 mm, aluminium
anodized, self-adhesive

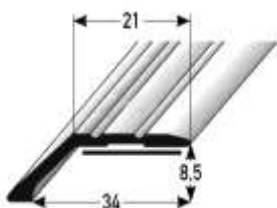

silberfarbig silver	1,0	47922-2	11,80	47926-0	12,82
	2,7	47924-6	31,90		
goldfarbig gold	1,0	47930-7	12,12	47934-5	12,96
	2,7	47932-1	32,58		
bronzef. hell bronze light	1,0	47938-3	12,96	47942-0	13,72
	2,7	47940-6	34,96		
bronzef. dunkel bronze dark	1,0	47946-8	12,96	47950-5	13,72
	2,7	47948-2	34,96		
gold hell gold light	1,0	48100-3	12,12	48104-1	12,84
	2,7	48102-7	32,58		
				48106-5	34,86

133 Abschlussprofil für Parkett, 47 x 15,5 mm, Aluminium eloxiert, gebohrt

adaptation profile for wooden
floor, 47 x 15,5 mm, aluminium
anodized, drilled

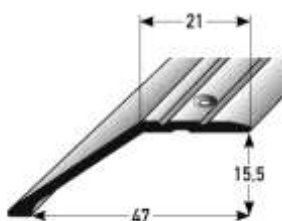

silberfarbig silver	1,0	41660-9	12,90	41661-6	FALSCH
	2,7	41670-8	34,80		
goldfarbig gold	1,0	41680-7	13,34	41681-4	14,38
	2,7	41690-6	36,02		
bronzef. hell bronze light	1,0	41700-2	14,52	41701-9	15,96
	2,7	41710-1	39,18		
bronzef. dunkel bronze dark	1,0	41720-0	14,52	41721-7	15,54
	2,7	41730-9	39,18		
gold hell gold light	1,0	62275-8	13,34	62285-7	14,38
	2,7	62280-2	36,02		
				62290-1	38,84

133 Abschlussprofil für Parkett, 47 x 15,5 mm, Aluminium eloxiert, selbstklebend

adaptation profile for wooden
floor, 47 x 15,5 mm, aluminium
anodized, self-adhesive

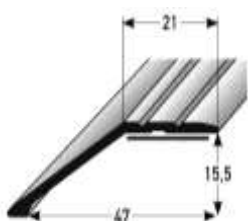

silberfarbig silver	1,0	47956-7	14,70	47960-4	15,46
	2,7	47958-1	39,72		
goldfarbig gold	1,0	47964-2	15,14	47968-0	15,92
	2,7	47966-6	40,96		
bronzef. hell bronze light	1,0	47972-7	16,36	47976-5	18,16
	2,7	47974-1	44,12		
bronzef. dunkel bronze dark	1,0	47980-2	16,36	47984-0	18,16
	2,7	47982-6	44,12		
gold hell gold light	1,0	48110-2	15,14	48114-0	15,92
	2,7	48112-6	40,96		
				48116-4	43,20

4. ÜBERGANGSPROFILE/ 4. CONNECTING PROFILES

Andere Eloxalfarben siehe
Abschnitt 6, Lieferzeit 14 Tage/
other anodized colours see section 6,
delivery time 14 days

137

Sockelprofil 8 x 18,4 mm, für Wandabschlüsse, Aluminium eloxiert, selbstklebend

plinth profile 8 x 18,4 mm,
as wall edging, aluminium
anodized, self-adhesive

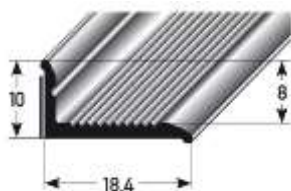

SB-Pack à 20 Stück			
self-service-pack à 20 pcs.			
Farbe/colour	L / l (m)	Art./ref.	€/Stk./pcs.
silberfarbig silver	0,9	41741-5	8,96
	2,7	41751-4	26,82
goldfarbig gold	0,9	41761-3	9,10
	2,7	41771-2	27,30
bronzefarbig hell bronze light	0,9	41781-1	11,36
	2,7	41791-0	34,10
edelstahlfarb./ AL-INOX stainless steel coloured	0,9	41800-9	9,56
	2,7	41810-8	28,70
gold hell gold light	0,9	62080-8	9,10
	2,7	62085-3	27,30
weiß pulverbeschichtet white powder coated	0,9	62090-7	10,26
	2,7	62095-2	30,76
Buche beech	0,9	41821-4	16,18
	2,7	41831-3	48,58
Eiche oak	0,9	41841-2	16,18
	2,7	41851-1	48,58
Ahorn maple	0,9	41861-0	16,18
	2,7	41871-9	48,58
Kirschbaum cherry wood	0,9	41844-3	16,18
	2,7	41854-2	48,58
Eiche rustikal rustic oak	0,9	41864-1	16,18
	2,7	41874-0	48,58

Holzdekorfolie/ wood decor

Profi-Pack à 10 Stück im Bund

professional packing à 10 pcs.

Farbe/colour	L / l (m)	Art./ref.	€/Stk./pcs.
--------------	-----------	-----------	-------------

SB-Pack incl. Schr./ Dübel; VE 20 Stk.

self-service-pack with screws/
dowels; à 20 pcs.

Art./ref.	€/Stk./pcs.
-----------	-------------

506

Abschlussprofil 28 x 3 mm, Aluminium elox., mittig gebohrt

adaptation profile 28 x 3 mm,
aluminium anodized, drilled

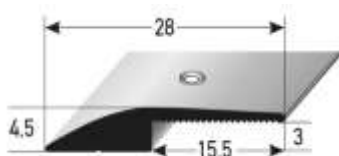

seitlich gebohrt auf Anfrage
laterally drilled on request

silberfarbig silver	1,0	71590-0	7,58
	2,7	71592-4	20,44
goldfarbig gold	1,0	71594-8	7,82
	2,7	71596-2	21,14
bronzef. hell bronze light	1,0	71598-6	8,40
	2,7	71600-6	22,66
bronzef. dunkel bronze dark	1,0	71602-0	8,66
	2,7	71604-4	23,42
edelstahlfarbig Feinschliff fine-honed stainless steel coloured	1,0	71606-8	8,66
	2,7	71608-2	23,42

71610-5	8,56
71612-9	23,38
71614-3	8,78
71616-7	24,04
71618-1	9,76
71620-4	26,72
71622-8	9,64
71624-2	26,34
71626-6	9,64
71628-0	26,34

506

Abschlussprofil 28 x 3 mm, Aluminium elox., ungebohrt

adaptation profile 28 x 3 mm,
aluminium anodized, undrilled

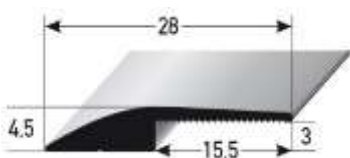

silberfarbig silver	1,0	71712-6	6,94
	2,7	71714-0	18,76
goldfarbig gold	1,0	71716-4	7,22
	2,7	71718-8	19,50
bronzef. hell bronze light	1,0	71720-1	8,06
	2,7	71722-5	21,80
bronzef. dunkel bronze dark	1,0	71724-9	8,06
	2,7	71726-3	21,80
edelstahlfarbig Feinschliff fine-honed stainless steel coloured	1,0	71728-7	8,06
	2,7	71730-0	21,80

71732-4	7,70
71734-8	20,80
71736-2	7,98
71738-6	21,52
71740-9	8,82
71742-3	23,82
71744-7	8,82
71746-1	23,82
71748-5	8,82
71750-8	23,82

5. EINSCHUB- & ANSTOßPROFILE AUS ALUMINIUM

5. INSERT PROFILES OUT OF ALUMINIUM

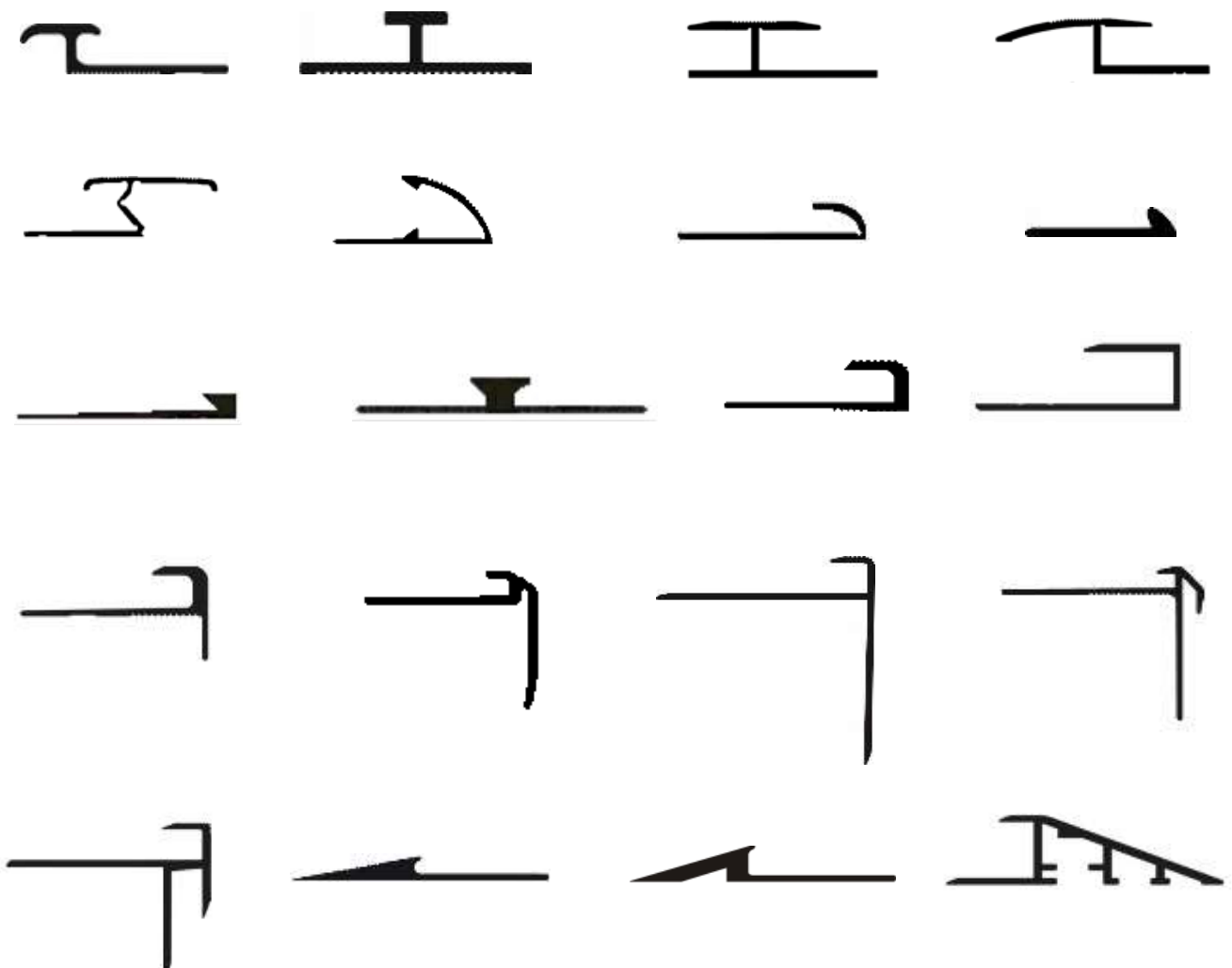

5. EINSCHUB- & ANSTOßPROFILE/ 5. INSERT PROFILES

Andere Eloxalfarben siehe
 Abschnitt 6, Lieferzeit 14 Tage/
 other anodized colours see section 6,
 delivery time 14 days

Profi-Pack à 10 Stück im Bund			
professional packing à 10 pcs.			
Farbe/colour	L / l (m)	Art./ref.	€/Stk./pcs.

SB-Pack incl. Schr./ Dübel; VE 20 Stk.	
self-service-pack with screws/ dowels; à 20 pcs.	
Art./ref.	€/Stk./pcs.

348 Doppelinsertprofil 14 x 3 mm, Aluminium eloxiert, gebohrt

double insert profile 14 x 3 mm,
 aluminium anodized,
 drilled



silberfarbig silver	1,0	65948-8	8,76
	2,7	65950-1	23,66
goldfarbig gold	1,0	65952-5	9,10
	2,7	65954-9	24,58
bronzef. hell bronze light	1,0	65956-3	10,18
	2,7	65958-7	27,56
bronzef. dunkel bronze dark	1,0	65960-0	10,18
	2,7	65962-4	27,56

65968-6	9,72
65970-9	26,58
65972-3	10,06
65974-7	27,48
65976-1	11,18
65978-5	30,44
65980-8	11,18
65982-2	30,44

347 Doppelinsertprofil 14 x 5 mm, Aluminium eloxiert, gebohrt

double insert profile 14 x 5 mm,
 aluminium anodized,
 drilled

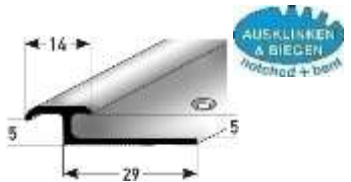

silberfarbig silver	1,0	65990-7	9,04
	2,7	65992-1	24,44
goldfarbig gold	1,0	65994-5	9,40
	2,7	65996-9	25,34
bronzef. hell bronze light	1,0	65998-3	10,54
	2,7	66000-2	28,44
bronzef. dunkel bronze dark	1,0	66002-6	10,54
	2,7	66004-0	28,44

66010-1	10,02
66012-5	27,32
66014-9	10,34
66016-3	28,22
66018-7	11,46
66020-0	31,34
66022-4	11,46
66024-8	31,34

346 Doppelinsertprofil 14 x 7 mm, Aluminium eloxiert, gebohrt

double insert profile 14 x 7 mm,
 aluminium anodized,
 drilled



silberfarbig silver	1,0	66074-3	9,36
	2,7	66076-7	25,24
goldfarbig gold	1,0	66078-1	9,70
	2,7	66080-4	26,22
bronzef. hell bronze light	1,0	66082-8	10,90
	2,7	66084-2	29,50
bronzef. dunkel bronze dark	1,0	66086-6	10,90
	2,7	66088-0	29,50

66094-1	10,32
66096-5	28,14
66098-9	10,68
66100-9	29,10
66102-3	11,86
66104-7	32,38
66106-1	11,86
66108-5	32,38



Befestigungsschenkel ausklinken attachment flanges notched
Befestigungsschenkel ausklinken und biegen attachment flanges notched and bent

Art./ref.	€/m
22240-8	7,16
auf Anfrage on request	

5. EINSCHUB- & ANSTOßPROFILE/ 5. INSERT PROFILES

Andere Eloxalfarben siehe
 Abschnitt 6, Lieferzeit 14 Tage/
 other anodized colours see section 6,
 delivery time 14 days

SB-Pack/ self-service-pack			
Farbe/colour	L / l (m)	Art./ref.	€/Stk./pcs.

579 Doppeleinschub 3,5 x 3,5 mm, Aluminium, ungebohrt, SB-verpackt

double insert profile
 3,5 x 3,5 mm, aluminium,
 undrilled

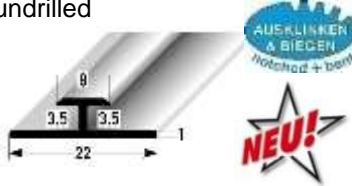

silberfarbig silver	2,7	72930-3	19,90
edelstahlfarbig stainless steel coloured		72932-7	26,08
schwarz black		72934-1	27,04

580 Doppeleinschub 5 x 5 mm, Aluminium, ungebohrt, SB-verpackt

double insert profile 5 x 5 mm,
 aluminium, undrilled

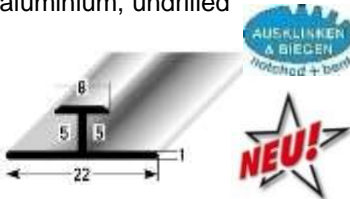

silberfarbig silver	2,7	72938-9	20,62
edelstahlfarbig stainless steel coloured		72940-2	27,06
schwarz black		72942-6	28,04



Befestigungsschenkel ausklinken attachment flanges notched		Art./ref.	€/m
		22240-8	7,16
Befestigungsschenkel ausklinken und biegen attachment flanges notched and bent		auf Anfrage on request	

Profi-Pack à 10 Stück im Bund				SB-Pack incl. Schr./ Dübel; VE 20 Stk.	
professional packing à 10 pcs.				self-service-pack with screws/ dowels; à 20 pcs.	
Farbe/colour	L / l (m)	Art./ref.	€/Stk./pcs.	Art./ref.	€/Stk./pcs.

130 Laminate-Übergang einteilig 27 x 8,3 x 38 mm, Aluminium eloxiert, gebohrt

laminate edge profile
 27 x 8,3 x 38 mm, one-piece,
 aluminium anodized, drilled

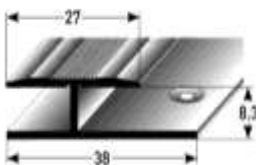

silberfarbig silver	1,0	41500-8	14,42	41501-5	15,50
	2,7	41510-7	38,98	41511-4	41,74
goldfarbig gold	1,0	41520-6	15,06	41521-3	16,06
	2,7	41530-5	40,66	41531-2	43,46
bronzef. hell bronze light	1,0	41540-4	16,46	41541-1	17,54
	2,7	41550-3	44,50	41551-0	47,26
bronzef. dunkel bronze dark	1,0	41560-2	16,46	41561-9	17,54
	2,7	41570-1	44,50	41571-8	47,26

131 Laminate-Höhenausgleich einteilig 33 x 8,3 x 45 mm, Aluminium eloxiert, gebohrt

laminate height levelling
 33 x 8,3 x 45 mm, one-piece,
 aluminium anodized, drilled

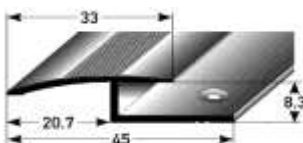

silberfarbig silver	1,0	41420-9	13,66	41421-6	14,70
	2,7	41430-8	36,84	41431-5	39,62
goldfarbig gold	1,0	41440-7	14,20	41441-4	15,20
	2,7	41450-6	38,38	41451-3	41,16
bronzef. hell bronze light	1,0	41460-5	15,54	41461-2	16,56
	2,7	41470-4	41,98	41471-1	44,80
bronzef. dunkel bronze dark	1,0	41480-3	15,54	41481-0	16,56
	2,7	41490-2	41,98	41491-9	44,80

5. EINSCHUB- & ANSTOßPROFILE/ 5. INSERT PROFILES

Andere Eloxalfarben siehe
 Abschnitt 6, Lieferzeit 14 Tage/
 other anodized colours see section 6,
 delivery time 14 days

Profi-Pack à 10 Stück im Bund			
professional packing à 10 pcs.			
Farbe/colour	L / l (m)	Art./ref.	€/Stk./pcs.

SB-Pack incl. Schr./ Dübel; VE 20 Stk.	
self-service-pack with screws/ dowels; à 20 pcs.	
Art./ref.	€/Stk./pcs.

2 0 Doppelklemmprofil, Aluminium eloxiert, gebohrt

double jam profile, aluminium
 anodized, drilled

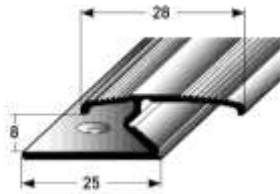

silberfarbig silver	0,9	25090-6	9,00
	1,0	25100-2	10,02
	2,7	25110-1	26,96
goldfarbig gold	0,9	25190-3	9,18
	1,0	25200-9	10,18
	2,7	25210-8	27,56
bronzef. hell bronze light	0,9	25290-0	10,76
	1,0	25300-6	11,92
	2,7	25310-5	32,16
bronzef. dunkel bronze dark	0,9	25390-7	10,76
	1,0	25400-3	11,92
	2,7	25410-2	32,16

25091-3	9,96
25101-9	11,02
25111-8	29,76
25191-0	10,10
25201-6	11,20
25211-5	30,32
25291-7	11,64
25301-3	12,90
25311-2	34,82
25391-4	11,64
25401-0	12,90
25411-9	34,82

auf Anfrage auch selbstklebend erhältlich/ self-adhesive version available on request

1 9 Einfachklemmprofil, Aluminium eloxiert, gebohrt

single jam profile, aluminium
 anodized, drilled

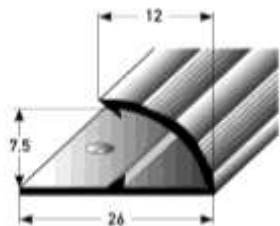

silberfarbig silver	0,9	24090-7	6,06
	1,0	24100-3	6,76
	2,7	24110-2	18,14
goldfarbig gold	0,9	24190-4	6,20
	1,0	24200-0	6,86
	2,7	24210-9	18,56
bronzef. hell bronze light	0,9	24290-1	6,90
	1,0	24300-7	7,70
	2,7	24310-6	20,76
bronzef. dunkel bronze dark	0,9	24390-8	6,90
	1,0	24400-4	7,70
	2,7	24410-3	20,76

24091-4	6,94
24101-0	7,74
24111-9	20,86
24191-1	7,12
24201-7	7,86
24211-6	21,26
24291-8	7,82
24301-4	8,66
24311-3	23,44
24391-5	7,82
24401-1	8,66
24411-0	23,44

auf Anfrage auch selbstklebend erhältlich/ self-adhesive version available on request

2 3 Miniklemmprofil, Aluminium eloxiert, ungebohrt

mini jam profile,
 aluminium anodized,
 undrilled

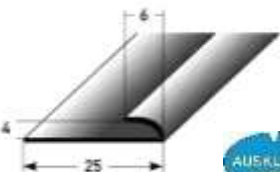

silberfarbig silver	1,0	36150-3	5,52
	2,7	36110-7	15,00
goldfarbig gold	1,0	36160-2	6,10
	2,7	36120-6	16,46
bronzef. hell bronze light	1,0	36170-1	7,46
	2,7	36130-5	20,26
bronzef. dunkel bronze dark	1,0	36180-0	7,46
	2,7	36140-4	20,26

36151-0	6,52
36111-4	17,74
36161-9	7,16
36121-3	19,18
36171-8	8,52
36131-2	22,98
36181-7	8,52
36141-1	22,98

auf Anfrage auch selbstklebend erhältlich/ self-adhesive version available on request



Befestigungsschenkel ausklinken attachment flanges notched	Art./ref.	€/m
Befestigungsschenkel ausklinken und biegen attachment flanges notched and bent	22240-8	7,16
	auf Anfrage on request	

Art./ref.	€/m
22240-8	7,16
auf Anfrage on request	

5. EINSCHUB- & ANSTOßPROFILE / 5. INSERT PROFILES

Andere Eloxalfarben siehe Abschnitt 6, Lieferzeit 14 Tage!
other anodized colours see section 6, delivery time 14 days

Profi-Pack à 10 Stück im Bund			
professional packing à 10 pcs.			
Farbe/colour	L / l (m)	Art./ref.	€/Stk./pcs.

SB-Pack incl. Schr./ Dübel; VE 20 Stk.	
self-service-pack with screws/ dowels; à 20 pcs.	
Art./ref.	€/Stk./pcs.

269 Einfassschiene 2 mm, Aluminium eloxiert, gebohrt

insert profile 2 mm, aluminium anodized, drilled



silberfarbig silver	2,7	46652-9	15,16	46664-2	17,90
goldfarbig gold		46654-3	15,52	46666-6	18,22
bronzefarbig hell bronze light		46656-7	17,24	46668-0	19,98
bronzef. dunkel bronze dark		46658-1	17,24	46670-3	19,98

387 Einfassschiene 2,5 mm, Aluminium eloxiert, gebohrt

insert profile 2,5 mm, aluminium anodized, drilled

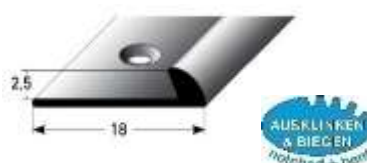

silberfarbig silver	2,7	66748-3	16,46	66764-3	19,18
goldfarbig gold		66750-6	16,86	66766-7	19,60
bronzefarbig hell bronze light		66752-0	18,60	66768-1	21,32
bronzef. dunkel bronze dark		66754-4	18,60	66770-4	21,32

2 2 Einfassschiene 3 mm, Aluminium eloxiert, gebohrt

insert profile 3 mm, aluminium anodized, drilled



silberfarbig silver	2,7	46674-1	16,78	46684-0	19,46
goldfarbig gold		46676-5	17,18	46686-4	19,86
bronzefarbig hell bronze light		46678-9	18,92	46688-8	21,58
bronzef. dunkel bronze dark		46680-2	18,92	46690-1	21,58

268 Einfassschiene 5 mm, Aluminium eloxiert, gebohrt

insert profile 5 mm, aluminium anodized, drilled



silberfarbig silver	2,7	46696-3	17,58	46708-3	20,32
goldfarbig gold		46698-7	17,86	46710-6	20,60
bronzefarbig hell bronze light		46700-7	19,60	46712-0	22,34
bronzef. dunkel bronze dark		46702-1	19,60	46714-4	22,34



Befestigungsschenkel ausklinken attachment flanges notched
Befestigungsschenkel ausklinken und biegen attachment flanges notched and bent

Art./ref.	€/m
22240-8	7,16
auf Anfrage on request	

5. EINSCHUB- & ANSTOßPROFILE/ 5. INSERT PROFILES

Andere Eloxalfarben siehe
 Abschnitt 6, Lieferzeit 14 Tage/
 other anodized colours see section 6,
 delivery time 14 days

Profi-Pack à 10 Stück im Bund			
professional packing à 10 pcs.			
Farbe/colour	L / l (m)	Art./ref.	€/Stk./pcs.

SB-Pack incl. Schr./ Dübel; VE 20 Stk.	
self-service-pack with screws/ dowels; à 20 pcs.	
Art./ref.	€/Stk./pcs.

2.7 Anstoßprofil 3 mm, Aluminium eloxiert, gebohrt

edge profile 3 mm, aluminium
 anodized, drilled

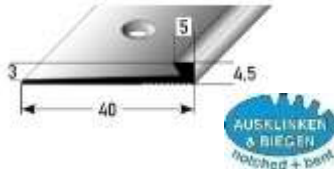

silberfarbig silver	2,7	47904-8	24,10
goldfarbig gold		47908-6	24,98
bronzefarbig hell bronze light		47912-3	27,74
bronzefarbig dunkel bronze dark		47916-1	27,74

47906-2	27,14
47910-9	28,00
47914-7	30,80
47918-5	30,80

2.9 Anstoßprofil 5/3, doppelseitig, Aluminium eloxiert, gebohrt

edge profile 5/3, double,
 aluminium anodized, drilled



silberfarbig silver	2,7	35870-1	25,06
goldfarbig gold		35880-0	26,70
bronzefarbig hell bronze light		35890-9	30,26
bronzefarbig dunkel bronze dark		35900-5	30,26

35871-8	27,80
35881-7	29,38
35891-6	32,98
35901-2	32,98



Befestigungsschenkel ausklinken attachment flanges notched		Art./ref.	€/m
		22240-8	7,16
Befestigungsschenkel ausklinken und biegen attachment flanges notched and bent		auf Anfrage on request	

2.8 Anstoßprofil 3/3, doppelseitig, Aluminium eloxiert, gebohrt

edge profile 3/3, double,
 aluminium anodized, drilled

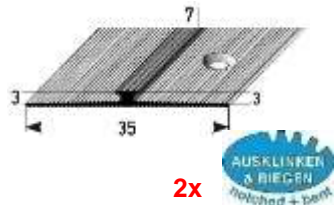

silberfarbig silver	2,7	35950-0	23,22
goldfarbig gold		35960-9	24,82
bronzefarbig hell bronze light		35970-8	28,64
bronzefarbig dunkel bronze dark		35980-7	28,64

35951-7	25,92
35961-6	27,54
35971-5	31,38
35981-4	31,38

3.0 Anstoßprofil 5/5, doppelseitig, Aluminium eloxiert, gebohrt

edge profile 5/5, double,
 aluminium anodized, drilled

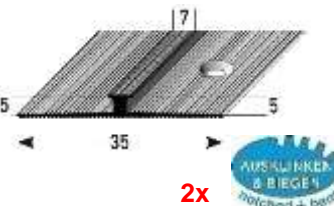

silberfarbig silver	2,7	36030-8	24,66
goldfarbig gold		36040-7	26,20
bronzefarbig hell bronze light		36050-6	29,94
bronzefarbig dunkel bronze dark		36060-5	29,94

36031-5	27,36
36041-4	28,92
36051-3	32,70
36061-2	32,70



2 x Befestigungsschenkel ausklinken 2 x attachment flanges notched		Art./ref.	€/m
		22260-6	14,32
Befestigungsschenkel ausklinken und biegen attachment flanges notched and bent		auf Anfrage on request	

5. EINSCHUB- & ANSTOßPROFILE / 5. INSERT PROFILES

Andere Eloxalfarben siehe
Abschnitt 6, Lieferzeit

14 Tage/ other anodized colours see
section 6, delivery time 14 days

Profi-Pack à 10 Stück im Bund			
professional packing à 10 pcs.			
Farbe/colour	L / l (m)	Art./ref.	€/Stk./pcs.

SB-Pack incl. Schr./ Dübel; VE 20 Stk.	
self-service-pack with screws/ dowels; à 20 pcs.	
Art./ref.	€/Stk./pcs.

282 Rampenanstoß 2 mm, Aluminium eloxiert, gebohrt

ramp profile 2 mm, aluminium
anodized, drilled



silberfarbig silver	1,0	35724-7	8,56	35740-7	9,56
	2,7	35726-1	23,10		
goldfarbig gold	1,0	35728-5	8,64	35744-5	9,64
	2,7	35730-8	23,42		
bronzefarbig hell bronze light	1,0	35732-2	8,98	35748-3	9,50
	2,7	35734-6	24,18		
bronzef. dunkel bronze dark	1,0	35736-0	8,98	35752-0	9,50
	2,7	35738-4	24,18		
edelstahlfarb./ AL-INOX stainless steel coloured	1,0	35710-0	8,98	35714-8	9,50
	2,7	35712-4	24,18		

283 Rampenanstoß 3 mm, Aluminium eloxiert, gebohrt

ramp profile 3 mm, aluminium
anodized, drilled



silberfarbig silver	1,0	35800-8	10,00	35816-9	11,02
	2,7	35802-2	26,86		
goldfarbig gold	1,0	35804-6	10,26	35820-6	11,26
	2,7	35806-0	27,70		
bronzefarbig hell bronze light	1,0	35808-4	11,16	35824-4	11,60
	2,7	35810-7	30,06		
bronzef. dunkel bronze dark	1,0	35812-1	11,16	35828-2	11,60
	2,7	35814-5	30,06		
edelstahlfarb./ AL-INOX stainless steel coloured	1,0	35720-9	11,16	35756-8	11,60
	2,7	35722-3	30,06		

284 Rampenanstoß 5 mm, Aluminium eloxiert, gebohrt

ramp profile 5 mm, aluminium
anodized, drilled

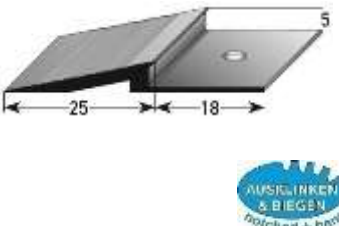

silberfarbig silver	1,0	35832-9	11,98	35848-0	12,40
	2,7	35834-3	32,40		
goldfarbig gold	1,0	35836-7	12,26	35852-7	12,64
	2,7	35838-1	33,14		
bronzefarbig hell bronze light	1,0	35840-4	14,42	35856-5	14,70
	2,7	35842-8	38,98		
bronzef. dunkel bronze dark	1,0	35844-2	14,42	35860-2	14,70
	2,7	35846-6	38,98		
edelstahlfarb./ AL-INOX stainless steel coloured	1,0	35762-9	14,42	35766-7	14,70
	2,7	35764-3	38,98		

480 Rampenanstoß 8 mm, Aluminium eloxiert, gebohrt

ramp profile 8 mm, aluminium
anodized, drilled

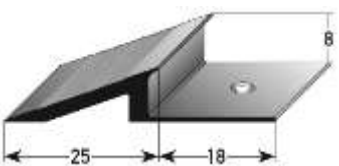

silberfarbig silver	1,0	70916-9	14,42	70936-7	14,70
	2,7	70918-3	38,90		
goldfarbig gold	1,0	70920-6	14,76	70940-4	15,00
	2,7	70922-0	39,78		
bronzefarbig hell bronze light	1,0	70924-4	17,30	70944-2	17,44
	2,7	70926-8	46,74		
bronzef. dunkel bronze dark	1,0	70928-2	17,30	70948-0	17,44
	2,7	70930-5	46,74		
edelstahlfarb./ AL-INOX stainless steel coloured	1,0	70932-9	17,30	70952-7	17,44
	2,7	70934-3	46,74		



Befestigungsschenkel ausklinken attachment flanges notched	
Befestigungsschenkel ausklinken und biegen attachment flanges notched and bent	

Art./ref.	€/m
22240-8	7,16
auf Anfrage on request	

5. EINSCHUB- & ANSTOßPROFILE/ 5. INSERT PROFILES

Andere Eloxalfarben siehe Abschnitt 6,
 Lieferzeit 14 Tage/ other anodized colours see
 section 6, delivery time 14 days

Profi-Pack à 10 Stück im Bund			
professional packing à 10 pcs.			
Farbe/colour	L / l (m)	Art./ref.	€/Stk./pcs.

525 Rampeneinschub 10 mm, Aluminium eloxiert, ungebohrt

ramp insertion profile 10 mm, aluminium
 anodized, undrilled

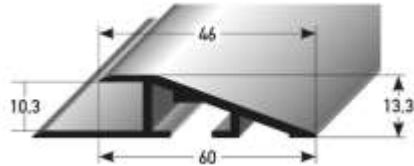

silberfarbig silver	2,7	72112-3	53,82
------------------------	-----	---------	-------

526 Rampeneinschub 15 mm, Aluminium eloxiert, ungebohrt

ramp insertion profile 15 mm, aluminium
 anodized, undrilled

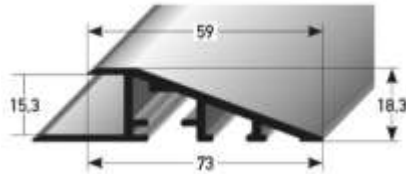

silberfarbig silver	2,7	72118-5	73,50
------------------------	-----	---------	-------

527 Rampeneinschub 22 mm, Aluminium eloxiert, ungebohrt

ramp insertion profile 22 mm, aluminium
 anodized, undrilled

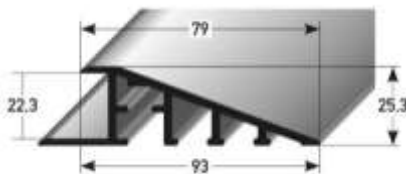

silberfarbig silver	2,7	72124-6	99,70
------------------------	-----	---------	-------

528 Längsverbinder für Rampeneinschubprofile, Stahl verzinkt

longitudinal connector for ramp insertion
 profiles, galvanized steel



Art./ref.	€/Stk./pcs.
72130-7	8,22

529 Eckverbinder für 90°-Ecke, für Rampeneinschubprofile, Stahl verzinkt

corner connector for 90° corner, for ramp
 insertion profiles, galvanized steel

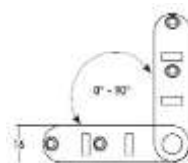

72136-9	18,62
---------	-------

536 Eckverbinder flexible Ecke, für Rampeneinschubprofile, Stahl verzinkt

corner connector for flexible corner, for ramp
 insertion profiles, galvanized steel

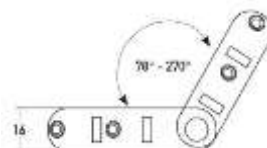

72131-4	18,62
---------	-------

5. EINSCHUB- & ANSTOßPROFILE / 5. INSERT PROFILES

Andere Eloxalfarben siehe
Abschnitt 6, Lieferzeit 14 Tage
other anodized colours see section 6,
delivery time 14 days

Profi-Pack à 10 Stück im Bund			
professional packing à 10 pcs.			
Farbe/colour	L / l (m)	Art./ref.	€/Stk./pcs.

SB-Pack incl. Schr./ Dübel; VE 20 Stk.	
self-service-pack with screws/ dowels; à 20 pcs.	
Art./ref.	€/Stk./pcs.

258 Einschubprofil 3 mm, Aluminium eloxiert, gebohrt

insert profile 3 mm,
aluminium anodized, drilled



silberfarbig silver	0,9	46718-2	6,62
	1,0	46720-5	7,34
	2,7	46722-9	19,84
goldfarbig gold	0,9	46732-8	6,84
	1,0	46734-2	7,62
	2,7	46736-6	20,50
bronzef. hell bronze light	0,9	46746-5	7,84
	1,0	46748-9	8,72
	2,7	46750-2	23,54
bronzef. dunkel bronze dark	0,9	46760-1	7,84
	1,0	46762-5	8,72
	2,7	46764-9	23,54

46724-3	7,64
46726-7	8,34
46728-1	22,92
46738-0	7,84
46740-3	8,60
46742-7	23,54
46752-6	8,86
46754-0	9,70
46756-4	26,56
46766-3	8,86
46768-7	9,70
46770-0	26,56

530 Einschubprofil 3 mm, Aluminium eloxiert, glatt, gebohrt

insert profile 3 mm, aluminium
anodized, smooth, drilled



silberfarbig silver	0,9	72142-0	7,08
	2,7	72144-4	21,20
edelstahlfarbig stainless steel coloured	0,9	72150-5	8,42
	2,7	72152-9	25,26
schwarz black	0,9	72578-7	8,42
	2,7	72580-0	25,26

72146-8	8,06
72148-2	24,18
72154-3	9,42
72156-7	28,26
72582-4	9,42
72584-8	28,26

18 Einschubprofil 5 mm, Aluminium eloxiert, gebohrt

insert profile 5 mm,
aluminium anodized, drilled

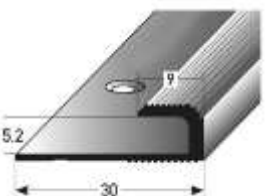

silberfarbig silver	0,9	26090-5	7,32
	1,0	26100-1	8,16
	2,7	26130-8	22,00
goldfarbig gold	0,9	26190-2	7,52
	1,0	26200-8	8,36
	2,7	26230-5	22,56
bronzef. hell bronze light	0,9	26290-9	8,96
	1,0	26300-5	9,98
	2,7	26330-2	26,82
bronzef. dunkel bronze dark	0,9	26390-6	8,96
	1,0	26400-2	9,98
	2,7	26430-9	26,82

26091-2	8,22
26101-8	9,14
26131-5	24,70
26191-9	8,46
26201-5	9,40
26231-2	25,34
26291-6	9,86
26301-2	10,96
26331-9	29,52
26391-3	9,86
26401-9	10,96
26431-6	29,52

531 Einschubprofil 5 mm, Aluminium eloxiert, glatt, gebohrt

insert profile 5 mm, aluminium
anodized, smooth, drilled

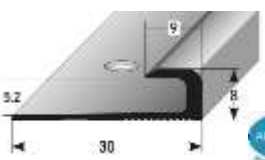

silberfarbig silver	0,9	72160-4	7,78
	2,7	72162-8	23,32
edelstahlfarbig stainless steel coloured	0,9	72168-0	9,98
	2,7	72170-3	29,92
schwarz black	0,9	72586-2	9,98
	2,7	72588-6	29,92

72164-2	8,76
72166-6	26,32
72172-7	10,98
72174-1	32,94
72590-9	10,98
72592-3	32,94



Befestigungsschenkel ausklinken attachment flanges notched		Art./ref.	€/m
		22240-8	7,16
Befestigungsschenkel ausklinken und biegen attachment flanges notched and bent		auf Anfrage on request	

5. EINSCHUB- & ANSTOßPROFILE/ 5. INSERT PROFILES

Andere Eloxalfarben siehe
Abschnitt 6, Lieferzeit 14 Tage
other anodized colours see section 6,
delivery time 14 days

Profi-Pack à 10 Stück im Bund			
professional packing à 10 pcs.			
Farbe/colour	L / l (m)	Art./ref.	€/Stk./pcs.

SB-Pack incl. Schr./ Dübel; VE 20 Stk.	
self-service-pack with screws/ dowels; à 20 pcs.	
Art./ref.	€/Stk./pcs.

24 Einschubprofil 6 mm, Aluminium eloxiert, gebohrt

insert profile 6 mm, aluminium
anodized, drilled

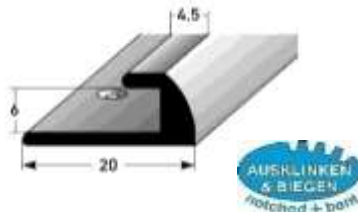

silberfarbig silver	2,7	47886-7	19,78	47888-1	22,82
goldfarbig gold		47890-4	20,10	47892-8	23,10
bronzef. hell bronze light		47894-2	22,58	47896-6	25,60
bronzef. dunkel bronze dark		47898-0	22,58	47900-0	25,60

auf Anfrage auch selbstklebend erhältlich/ self-adhesive version available on request

446 Einschubprofil für Laminat 7,5 mm, Aluminium eloxiert, gebohrt

insert profile for laminate 7,5 mm,
aluminium anodized, drilled

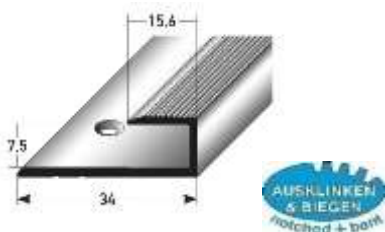

silberfarbig silver	1,0	48120-1	6,74	48124-9	7,74
	2,7	48122-5	18,14	48126-3	21,20
goldfarbig gold	1,0	48128-7	6,90	48132-4	7,92
	2,7	48130-0	18,62	48134-8	21,70
bronzef. hell bronze light	1,0	48144-7	7,52	48148-5	8,54
	2,7	48146-1	20,24	48150-8	23,32
bronzef. dunkel bronze dark	1,0	48152-2	7,52	48156-0	8,54
	2,7	48154-6	20,24	48158-4	23,32

108 Einschubprofil für Laminat 8,5 mm, Aluminium eloxiert, gebohrt

insert profile for laminate 8,5 mm,
aluminium anodized,
drilled



silberfarbig silver	1,0	29160-2	7,20	29166-4	8,22
	2,7	29165-7	19,46	29167-1	22,22
goldfarbig gold	1,0	29170-1	7,40	29176-3	8,46
	2,7	29175-6	20,10	29177-0	22,84
bronzef. hell bronze light	1,0	29180-0	8,04	29186-2	9,06
	2,7	29185-5	21,76	29187-9	24,46
bronzef. dunkel bronze dark	1,0	29190-9	8,04	29196-1	9,06
	2,7	29195-4	21,76	29197-8	24,46
gold hell gold light	1,0	62135-5	7,40	62145-4	8,46
	2,7	62140-9	20,10	62155-3	22,84
Buche beech	1,0	40580-1	10,76	40581-8	11,80
	2,7	40600-6	28,98	40601-3	31,86
Eiche oak	1,0	40610-5	10,76	40611-2	11,80
	2,7	40630-3	28,98	40631-0	31,86
Ahorn maple	1,0	40640-2	10,76	40641-9	11,80
	2,7	40660-0	28,98	40661-7	31,86
Kirschbaum cherry wood	1,0	43154-1	10,76	43156-5	11,80
	2,7	43158-9	28,98	43160-2	31,86
Eiche rustikal rustic oak	1,0	43162-6	10,76	43164-0	11,80
	2,7	43166-4	28,98	43168-8	31,86

Holzdekorfolie/ wood decor



Befestigungsschenkel ausklinken attachment flanges notched	Art./ref.	€/m
Befestigungsschenkel ausklinken und biegen attachment flanges notched and bent	22240-8	7,16
	auf Anfrage on request	

5. EINSCHUB- & ANSTOßPROFILE/ 5. INSERT PROFILES

Andere Eloxalfarben siehe
 Abschnitt 6, Lieferzeit 14 Tage
 other anodized colours see
 section 6, delivery time 14 days

Profi-Pack à 10 Stück im Bund			
professional packing à 10 pcs.			
Farbe/colour	L / l (m)	Art./ref.	€/Stk./pcs.

SB-Pack incl. Schr./ Dübel; VE 20 Stk.	
self-service-pack with screws/ dowels; à 20 pcs.	
Art./ref.	€/Stk./pcs.

532 Einschubprofil 8,5 mm, Aluminium eloxiert, glatt, gebohrt

insert profile 8,5 mm, aluminium
 anodized, smooth, drilled

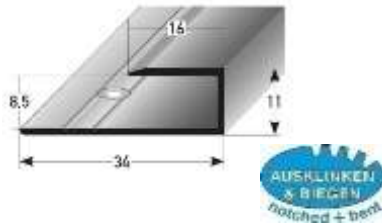

silberfarbig silver	0,9	72178-9	9,10
	2,7	72180-2	27,32
edelstahlfarbig stainless steel coloured	0,9	72186-4	12,12
	2,7	72188-8	36,32
schwarz black	0,9	72570-1	12,12
	2,7	72572-5	36,32

72182-6	10,10
72184-0	30,32
72190-1	13,12
72192-5	39,34
72574-9	13,12
72576-3	39,34

109 Einschubprofil für Parkett 10 mm, Aluminium eloxiert, gebohrt

insert profile for wooden floor,
 10 mm, aluminium anodized,
 drilled

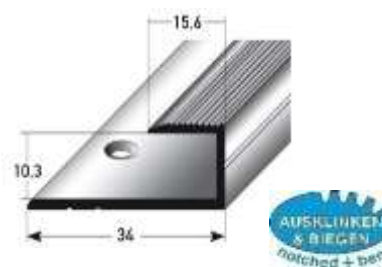

silberfarbig silver	1,0	29500-6	8,94
	2,7	29505-1	23,98
goldfarbig gold	1,0	29510-5	9,80
	2,7	29515-0	26,44
bronzef. hell bronze light	1,0	29520-4	11,34
	2,7	29525-9	30,72
bronzef. dunkel bronze dark	1,0	29530-3	11,34
	2,7	29535-8	30,72

29506-8	9,96
29507-5	26,72
29516-7	10,82
29517-4	29,20
29526-6	12,36
29527-3	33,38
29536-5	12,36
29537-2	33,38

110 Einschubprofil für Parkett 13 mm, Aluminium eloxiert, gebohrt

insert profile for wooden floor,
 13 mm, aluminium anodized,
 drilled

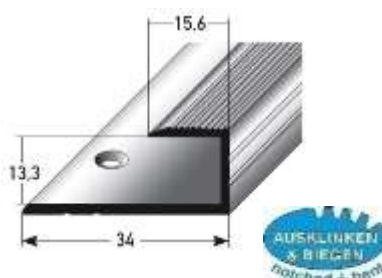

silberfarbig silver	1,0	29540-2	9,70
	2,7	29545-7	26,24
goldfarbig gold	1,0	29550-1	10,12
	2,7	29555-6	27,34
bronzef. hell bronze light	1,0	29560-0	11,72
	2,7	29565-5	31,50
bronzef. dunkel bronze dark	1,0	29570-9	11,72
	2,7	29575-4	31,50

29546-4	10,76
29547-1	28,98
29556-3	11,16
29557-0	30,06
29566-2	12,70
29567-9	34,24
29576-1	12,70
29577-8	34,24



Befestigungsschenkel ausklinken attachment flanges notched
Befestigungsschenkel ausklinken und biegen attachment flanges notched and bent

Art./ref.	€/m
22240-8	7,16
auf Anfrage on request	

5. EINSCHUB- & ANSTOßPROFILE/ 5. INSERT PROFILES

Andere Eloxalfarben siehe
 Abschnitt 6, Lieferzeit 14 Tage
 other anodized colours see
 section 6, delivery time 14 days

Profi-Pack à 10 Stück im Bund			
professional packing à 10 pcs.			
Farbe/colour	L / l (m)	Art./ref.	€/Stk./pcs.

SB-Pack incl. Schr./ Dübel; VE 20 Stk.	
self-service-pack with screws/ dowels; à 20 pcs.	
Art./ref.	€/Stk./pcs.

111 Einschubprofil für Parkett 15 mm, Aluminium eloxiert, gebohrt

insert profile for wooden floor,
 15 mm, aluminium anodized,
 drilled



silberfarbig silver	1,0	29580-8	10,36
	2,7	29585-3	28,02
goldfarbig gold	1,0	29590-7	10,86
	2,7	29595-2	29,38
bronzef. hell bronze light	1,0	29600-3	12,30
	2,7	29605-8	33,22
bronzef. dunkel bronze dark	1,0	29610-2	12,30
	2,7	29615-7	33,22
gold hell gold light	1,0	62100-3	10,86
	2,7	62105-8	29,38

29586-0	11,36
29587-7	30,74
29596-9	11,90
29597-6	32,06
29606-5	13,32
29607-2	35,94
29616-4	13,32
29617-1	35,94
62110-2	11,90
62120-1	32,06

Holzdekorfolie/ wood decor			
	Buche beech	1,0	40670-9
	2,7	40690-7	32,98
Eiche oak	1,0	40700-3	12,22
	2,7	40720-1	32,98
Ahorn maple	1,0	40730-0	12,22
	2,7	40750-8	32,98
Kirschbaum cherry wood	1,0	43172-5	12,22
	2,7	43176-3	32,98
Eiche rustikal rustic oak	1,0	43180-0	12,22
	2,7	43184-8	32,98

40671-6	13,26
40691-4	35,86
40701-0	13,26
40721-8	35,86
40731-7	13,26
40751-5	35,86
43174-9	13,26
43178-7	35,86
43182-4	13,26
43186-2	35,86

533 Einschubprofil 15,5 mm, Aluminium eloxiert, glatt, gebohrt

insert profile 15,5 mm,
 aluminium anodized, smooth,
 drilled

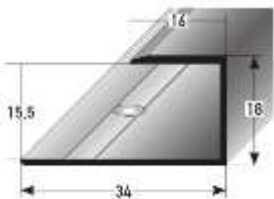

silberfarbig silver	0,9	72196-3	10,00
	2,7	72198-7	30,00
edelstahlfarbig stainless steel coloured	0,9	72204-5	13,32
	2,7	72206-9	39,98
schwarz black	0,9	72562-6	13,32
	2,7	72564-0	39,98

72200-7	11,00
72202-1	33,00
72208-3	14,34
72210-6	43,00
72566-4	14,34
72568-8	43,00



Befestigungsschenkel ausklinken attachment flanges notched

Befestigungsschenkel ausklinken und biegen attachment flanges notched and bent

Art./ref.	€/m
22240-8	7,16

auf Anfrage on request	
---------------------------	--

5. EINSCHUB- & ANSTOßPROFILE/ 5. INSERT PROFILES

Andere Eloxalfarben siehe
 Abschnitt 6, Lieferzeit 14 Tage
 other anodized colours see
 section 6, delivery time 14 days

Profi-Pack à 10 Stück im Bund			
professional packing à 10 pcs.			
Farbe/colour	L / l (m)	Art./ref.	€/Stk./pcs.

SB-Pack incl. Schr./ Dübel; VE 20 Stk.	
self-service-pack with screws/ dowels; à 20 pcs.	
Art./ref.	€/Stk./pcs.

21 Einschubprofil 3 mm mit 7 mm Nase, Aluminium eloxiert, gebohrt

insert profile 3 mm with 7 mm
 nose, aluminium anodized,
 drilled



silberfarbig silver	0,9	32070-8	6,92
	1,0	32075-3	7,74
	2,7	32080-7	20,80
goldfarbig gold	0,9	32085-2	7,32
	1,0	32090-6	8,16
	2,7	32095-1	21,96
bronzef. hell bronze light	0,9	32100-2	8,46
	1,0	32105-7	9,36
	2,7	32110-1	25,24
bronzef. dunkel bronze dark	0,9	32115-6	8,46
	1,0	32120-0	9,36
	2,7	32125-5	25,24

32071-5	7,84
32076-0	8,66
32081-4	23,50
32086-9	8,22
32091-3	9,14
32096-8	24,66
32101-9	9,36
32106-4	10,36
32111-8	28,02
32116-3	9,36
32121-7	10,36
32126-2	28,02

534 Einschubprofil 3 mm mit 7 mm Nase, Aluminium eloxiert, glatt, gebohrt

insert profile 3 mm with 7 mm
 nose, aluminium anodized,
 smooth, drilled

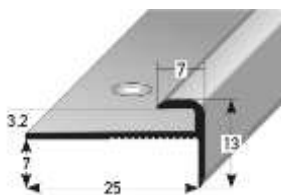

silberfarbig silver	0,9	72214-4	7,06
	2,7	72216-8	21,14
edelstahlfarbig stainless steel coloured	0,9	72222-9	9,28
	2,7	72224-3	27,86
schwarz black	0,9	72554-1	9,28
	2,7	72556-5	27,86

72218-2	8,04
72220-5	24,12
72226-7	10,30
72228-1	30,86
72558-9	10,30
72560-2	30,86

478 Einschubprofil 3 mm mit 24 mm Nase, Aluminium eloxiert, gebohrt

insert profile 3 mm with 24 mm
 nose, alu anodized, drilled



silberfarbig silver	1,0	70862-9	11,86
	2,7	70864-3	32,06
goldfarbig gold	1,0	70870-4	12,16
	2,7	70872-8	32,76
bronzef. hell bronze light	1,0	70878-0	13,72
	2,7	70880-3	37,02
bronzef. dunkel bronze dark	1,0	70886-5	13,72
	2,7	70888-9	37,02

70866-7	12,82
70868-1	34,78
70874-2	13,16
70876-6	35,46
70882-7	14,70
70884-1	39,80
70890-2	14,70
70892-6	39,80



Befestigungsschenkel ausklinken attachment flanges notched
Befestigungsschenkel ausklinken und biegen attachment flanges notched and bent

Art./ref.	€/m
22240-8	7,16
auf Anfrage on request	

5. EINSCHUB- & ANSTOßPROFILE / 5. INSERT PROFILES

Andere Eloxalfarben siehe
 Abschnitt 6, Lieferzeit 14 Tage
 other anodized colours see
 section 6, delivery time 14 days

Profi-Pack à 10 Stück im Bund			
professional packing à 10 pcs.			
Farbe/colour	L / l (m)	Art./ref.	€/Stk./pcs.

SB-Pack incl. Schr./ Dübel; VE 20 Stk.	
self-service-pack with screws/ dowels; à 20 pcs.	
Art./ref.	€/Stk./pcs.

501 Einschubprofil 3 mm mit 44 mm Nase, Aluminium eloxiert, gebohrt

insert profile 3 mm with 44 mm
 nose, alu anodized, drilled

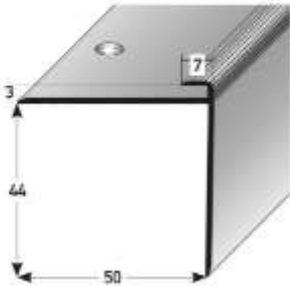

silberfarbig silver	1,0	71462-0	12,82
	2,7	71464-4	34,60
goldfarbig gold	1,0	71466-8	16,36
	2,7	71468-2	44,14
bronzef. hell bronze light	1,0	71470-5	18,10
	2,7	71472-9	48,86
bronzef. dunkel bronze dark	1,0	71474-3	18,92
	2,7	71476-7	51,02

71478-1	13,78
71480-4	37,56
71482-8	17,32
71484-2	47,06
71486-6	19,06
71488-0	51,78
71490-3	19,86
71492-7	53,94



17 Einschubprofil 5 mm mit 7 mm Nase, Aluminium eloxiert, gebohrt

insert profile 5 mm with 7 mm
 nose, aluminium anodized,
 drilled



silberfarbig silver	0,9	27090-4	8,32
	1,0	27100-0	9,20
	2,7	27130-7	24,96
goldfarbig gold	0,9	27190-1	8,52
	1,0	27200-7	9,44
	2,7	27230-4	25,46
bronzef. hell bronze light	0,9	27290-8	10,02
	1,0	27300-4	11,14
	2,7	27330-1	29,96
bronzef. dunkel bronze dark	0,9	27390-5	10,02
	1,0	27400-1	11,14
	2,7	27430-8	29,96

27091-1	9,20
27101-7	10,22
27131-4	27,64
27191-8	9,42
27201-4	10,44
27231-1	28,22
27291-5	10,90
27301-1	12,14
27331-8	32,72
27391-2	10,90
27401-8	12,14
27431-5	32,72



535 Einschubprofil 5 mm mit 7 mm Nase, Aluminium eloxiert, glatt, gebohrt

insert profile 5 mm with 7 mm
 nose, aluminium anodized,
 smooth, drilled

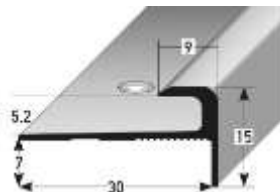

silberfarbig silver	0,9	72232-8	8,56
	2,7	72234-2	25,68
edelstahlfarbig stainless steel coloured	0,9	72240-3	11,12
	2,7	72242-7	33,34
schwarz black	0,9	72546-6	11,12
	2,7	72548-0	33,34

72236-6	9,56
72238-0	28,66
72244-1	12,12
72246-5	36,32
72550-3	12,12
72552-7	36,32



Befestigungsschenkel ausklinken attachment flanges notched
Befestigungsschenkel ausklinken und biegen attachment flanges notched and bent

Art./ref.	€/m
22240-8	7,16
auf Anfrage on request	

5. EINSCHUB- & ANSTOßPROFILE/ 5. INSERT PROFILES

Andere Eloxalfarben siehe
 Abschnitt 6, Lieferzeit 14 Tage
 other anodized colours see
 section 6, delivery time 14 days

Profi-Pack à 10 Stück im Bund			
professional packing à 10 pcs.			
Farbe/colour	L / l (m)	Art./ref.	€/Stk./pcs.

SB-Pack incl. Schr./ Dübel; VE 20 Stk.	
self-service-pack with screws/ dowels; à 20 pcs.	
Art./ref.	€/Stk./pcs.

93 Treppeneinschubprofil 5 mm mit 24 mm Nase, Aluminium eloxiert, gebohrt

insert profile 5 mm with 24 mm
 nose, aluminium anodized,
 drilled



silberfarbig silver	0,9	32005-0	11,98	32006-7	12,94	
	1,0	32010-4	13,34		32011-1	14,36
	2,7	32015-9	36,02		32016-6	38,78
goldfarbig gold	0,9	32020-3	12,12	32021-0	13,00	
	1,0	32025-8	13,42	32026-5	14,42	
	2,7	32030-2	36,30	32031-9	39,00	
bronzef. hell bronze light	0,9	32035-7	13,94	32036-4	14,80	
	1,0	32040-1	15,46	32041-8	16,44	
	2,7	32045-6	41,66	32046-3	44,40	
bronzef. dunkel bronze dark	0,9	32050-0	13,94	32051-7	14,80	
	1,0	32055-5	15,46	32056-2	16,44	
	2,7	32060-9	41,66	32061-6	44,40	

32006-7	12,94
32011-1	14,36
32016-6	38,78
32021-0	13,00
32026-5	14,42
32031-9	39,00
32036-4	14,80
32041-8	16,44
32046-3	44,40
32051-7	14,80
32056-2	16,44
32061-6	44,40

502 Treppeneinschubprofil 5 mm mit 44 mm Nase, Aluminium eloxiert, gebohrt

insert profile 5 mm with 44 mm
 nose, aluminium anodized,
 drilled



silberfarbig silver	1,0	71498-9	13,12	71514-6	14,06
	2,7	71500-9	35,38		71516-0
goldfarbig gold	1,0	71502-3	16,66	71518-4	17,64
	2,7	71504-7	45,00	71520-7	47,96
bronzef. hell bronze light	1,0	71506-1	18,46	71522-1	19,44
	2,7	71508-5	49,86	71524-5	52,78
bronzef. dunkel bronze dark	1,0	71510-8	19,26	71526-9	20,24
	2,7	71512-2	52,04	71528-3	54,96

71514-6	14,06
71516-0	38,30
71518-4	17,64
71520-7	47,96
71522-1	19,44
71524-5	52,78
71526-9	20,24
71528-3	54,96

105 Einschubprofil 8,5 mm mit 7 mm Nase für Laminat, Aluminium eloxiert, gebohrt

insert profile 8,5 mm with 7 mm
 nose, aluminium anodized,
 drilled

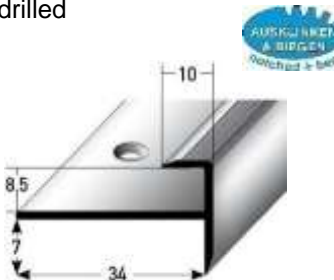

silberfarbig silver	1,0	32140-8	10,28	32141-5	11,26
	2,7	32145-3	27,74		32146-0
goldfarbig gold	1,0	32155-2	10,62	32156-9	11,60
	2,7	32160-6	28,58	32161-3	31,60
bronzef. hell bronze light	1,0	32170-5	11,20	32171-2	12,20
	2,7	32175-0	30,22	32176-7	33,24
bronzef. dunkel bronze dark	1,0	32185-9	11,20	32186-6	12,20
	2,7	32190-3	30,22	32191-0	33,24
gold hell gold light	1,0	62175-1	10,62	62190-4	11,60
	2,7	62180-5	28,58	62195-9	31,60

32141-5	11,26
32146-0	30,80
32156-9	11,60
32161-3	31,60
32171-2	12,20
32176-7	33,24
32186-6	12,20
32191-0	33,24
62190-4	11,60
62195-9	31,60



Befestigungsschenkel ausklinken attachment flanges notched
Befestigungsschenkel ausklinken und biegen attachment flanges notched and bent

Art./ref.	€/m
22240-8	7,16
auf Anfrage on request	

5. EINSCHUB- & ANSTOßPROFILE/ 5. INSERT PROFILES

Andere Eloxalfarben siehe
 Abschnitt 6, Lieferzeit 14 Tage
 other anodized colours see
 section 6, delivery time 14 days

Profi-Pack à 10 Stück im Bund			
professional packing à 10 pcs.			
Farbe/colour	L / l (m)	Art./ref.	€/Stk./pcs.

SB-Pack incl. Schr./ Dübel; VE 20 Stk.	
self-service-pack with screws/ dowels; à 20 pcs.	
Art./ref.	€/Stk./pcs.

265 Einschubprofil 8,5 mm mit 44 mm Nase für Laminat, Aluminium eloxiert, gebohrt

insert profile 8,5 mm with 44 mm
 nose, aluminium anodized, drilled

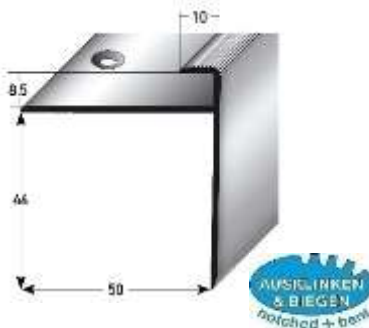

silberfarbig silver	1,0	46234-7	16,64	46240-8	17,62
	2,7	46236-1	44,92		
goldfarbig gold	1,0	46248-4	17,34	46254-5	18,34
	2,7	46250-7	46,92		
bronzef. hell bronze light	1,0	46262-0	19,10	46268-2	20,10
	2,7	46264-4	51,56		
bronzef. dunkel bronze dark	1,0	46276-7	19,10	46282-8	20,10
	2,7	46278-1	51,56		
gold hell gold light	1,0	46438-9	17,34	46442-6	18,34
	2,7	46440-2	46,92		

46240-8	17,62
46254-5	18,34
46268-2	20,10
46282-8	20,10
46442-6	18,34

262 Einschubprofil 10 mm mit 7 mm Nase für Parkett, Aluminium eloxiert, gebohrt

insert profile 10 mm, with 7mm
 nose, aluminium anodized, drilled

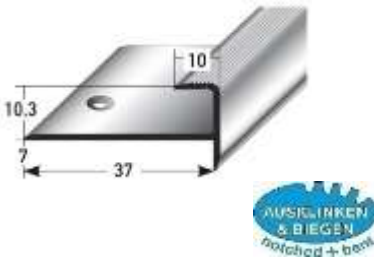

silberfarbig silver	1,0	46122-7	10,90	46128-9	11,92
	2,7	46124-1	29,50		
goldfarbig gold	1,0	46136-4	11,38	46142-5	12,40
	2,7	46138-8	30,80		
bronzef. hell bronze light	1,0	46150-0	12,46	46156-2	13,48
	2,7	46152-4	33,72		
bronzef. dunkel bronze dark	1,0	46164-7	12,46	46170-8	13,48
	2,7	46166-1	33,72		
gold hell gold light	1,0	46448-8	11,38	46452-5	12,40
	2,7	46450-1	30,80		

46128-9	11,92
46142-5	12,40
46156-2	13,48
46170-8	13,48
46452-5	12,40

427 Einschubprofil 10,5 mm mit 44 mm Nase für Parkett, Aluminium eloxiert, gebohrt

insert profile 10,5 mm with 44 mm
 nose, aluminium anodized, drilled



silberfarbig silver	1,0	67100-8	17,54	67124-4	18,54
	2,7	67102-2	47,30		
goldfarbig gold	1,0	67104-6	18,22	67128-2	19,22
	2,7	67106-0	49,24		
bronzef. hell bronze light	1,0	67112-1	19,98	67136-7	20,94
	2,7	67114-5	53,92		
bronzef. dunkel bronze dark	1,0	67116-9	19,98	67140-4	20,94
	2,7	67118-3	53,92		
gold hell gold light	1,0	67108-4	18,22	67132-9	19,22
	2,7	67110-7	49,24		

67124-4	18,54
67128-2	19,22
67136-7	20,94
67140-4	20,94
67132-9	19,22



Befestigungsschenkel ausklinken attachment flanges notched

Art./ref.	€/m
22240-8	7,16

Befestigungsschenkel ausklinken und biegen attachment flanges notched and bent

auf Anfrage on request

5. EINSCHUB- & ANSTOßPROFILE / 5. INSERT PROFILES

Andere Eloxalfarben siehe
 Abschnitt 6, Lieferzeit 14 Tage
 other anodized colours see
 section 6, delivery time 14 days

Profi-Pack à 10 Stück im Bund			
professional packing à 10 pcs.			
Farbe/colour	L / l (m)	Art./ref.	€/Stk./pcs.

SB-Pack incl. Schr./ Dübel; VE 20 Stk.	
self-service-pack with screws/ dowels; à 20 pcs.	
Art./ref.	€/Stk./pcs.

263 Einschubprofil 13 mm mit 7 mm Nase für Parkett, Aluminium eloxiert, gebohrt

insert profile 13 mm with 7mm
 nose, aluminium anodized, drilled

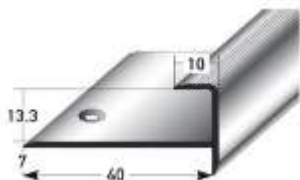

silberfarbig silver	1,0	46178-4	11,80	46184-5	12,82
	2,7	46180-7	31,90		
goldfarbig gold	1,0	46192-0	12,24	46186-9	34,90
	2,7	46194-4	33,12		
bronzef. hell bronze light	1,0	46206-4	13,34	46198-2	13,26
	2,7	46208-8	36,00		
bronzef. dunkel bronze dark	1,0	46220-0	13,34	46212-5	14,36
	2,7	46222-4	36,00		
gold hell gold light	1,0	46458-7	12,24	46214-9	39,06
	2,7	46460-0	33,12		

46184-5	12,82
46198-2	13,26
46212-5	14,36
46226-2	14,36
46462-4	13,26

112 Einschubprofil 15 mm mit 12 mm Nase für Parkett, Aluminium eloxiert, gebohrt

insert profile 15 mm, with 12 mm
 nose, aluminium anodized, drilled

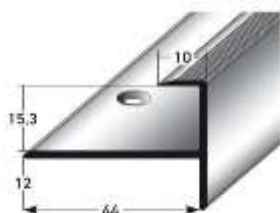

silberfarbig silver	1,0	37020-8	10,34	37021-5	11,24
	2,7	37030-7	27,86		
goldfarbig gold	1,0	37040-6	13,60	37031-4	30,76
	2,7	37050-5	36,74		
bronzef. hell bronze light	1,0	37060-4	14,22	37041-3	14,60
	2,7	37070-3	38,40		
bronzef. dunkel bronze dark	1,0	37080-2	14,22	37051-2	39,78
	2,7	37090-1	38,40		
gold hell gold light	1,0	62210-9	13,60	37061-1	15,20
	2,7	62215-4	36,74		

37021-5	11,24
37041-3	14,60
37061-1	15,20
37081-9	15,20
62220-8	14,60



Befestigungsschenkel ausklinken attachment flanges notched
Befestigungsschenkel ausklinken und biegen attachment flanges notched and bent

Art./ref.	€/m
22240-8	7,16
auf Anfrage on request	

5. EINSCHUB- & ANSTOßPROFILE/ 5. INSERT PROFILES

Andere Eloxafarben siehe
 Abschnitt 6, Lieferzeit 14 Tage/
 other anodized colours see
 section 6, delivery time 14 days

Profi-Pack à 10 Stück im Bund			
professional packing à 10 pcs.			
Farbe/colour	L / l (m)	Art./ref.	€/Stk./pcs.

SB-Pack incl. Schr./ Dübel; VE 20 Stk.	
self-service-pack with screws/ dowels; à 20 pcs.	
Art./ref.	€/Stk./pcs.

491 Treppenkante Doppelseinschub 3 mm, Aluminium eloxiert, 2 x gebohrt

double insert stair nosing
 3 mm, aluminium anodized,
 2 x drilled

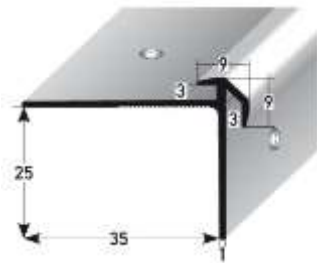

silberfarbig silver	1,0	71144-5	13,06	71168-1	14,00
	2,7	71146-9	35,30		
goldfarbig gold	1,0	71148-3	13,62	71170-4	38,06
	2,7	71150-6	36,78		
bronzef. hell bronze light	1,0	71152-0	16,02	71172-8	14,56
	2,7	71154-4	43,24		
bronzef. dunkel bronze dark	1,0	71156-8	16,02	71174-2	40,84
	2,7	71158-2	43,24		
gold hell gold light	1,0	71160-5	13,62	71176-6	16,94
	2,7	71162-9	36,78		
edelstahlfarbig stainless steel coloured	1,0	71164-3	16,02	71178-0	46,04
	2,7	71166-7	43,24		

71168-1	14,00
71172-8	14,56
71176-6	16,94
71180-3	16,94
71184-1	14,56
71188-9	16,94

492 Treppenkante Doppelseinschub 5 mm, Aluminium eloxiert, 2 x gebohrt

double insert stair nosing
 5 mm, aluminium anodized,
 2 x drilled

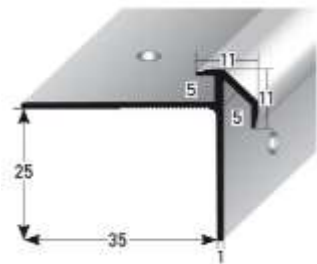

silberfarbig silver	1,0	71196-4	13,58	71220-6	14,50
	2,7	71198-8	36,64		
goldfarbig gold	1,0	71200-8	14,24	71222-0	39,42
	2,7	71202-2	38,46		
bronzef. hell bronze light	1,0	71204-6	16,58	71224-4	15,16
	2,7	71206-0	44,76		
bronzef. dunkel bronze dark	1,0	71208-4	16,58	71226-8	41,24
	2,7	71210-7	44,76		
gold hell gold light	1,0	71212-1	14,24	71228-2	17,52
	2,7	71214-5	38,46		
edelstahlfarbig stainless steel coloured	1,0	71216-9	16,58	71230-5	47,52
	2,7	71218-3	44,76		

71220-6	14,50
71224-4	15,16
71228-2	17,52
71232-9	17,52
71236-7	15,16
71240-4	17,52

**Technische Datenblätter, Verlegehinweise, Materialbeschreibungen & Pflegehinweise
 erhalten Sie auf Anfrage oder unter www.Auer-Metallprofile.de**

Technical details, installation tips, material descriptions and care instructions are available
 on request or under www.Auer-Metallprofile.de

5. EINSCHUB- & ANSTOßPROFILE/ 5. INSERT PROFILES

Andere Eloxalfarben siehe
Abschnitt 6, Lieferzeit 14 Tage
other anodized colours see
section 6, delivery time 14 days

Profi-Pack à 10 Stück im Bund			
professional packing à 10 pcs.			
Farbe/colour	L / l (m)	Art./ref.	€/Stk./pcs.

SB-Pack incl. Schr./ Dübel; VE 20 Stk.	
self-service-pack with screws/ dowels; à 20 pcs.	
Art./ref.	€/Stk./pcs.

101 Treppenkante für Laminat 20 x 33 x 8,5 mm, Aluminium eloxiert, 2 x gebohrt

stair nosing for laminate
20 x 33 x 8,5 mm,
aluminium anodized, 2 x drilled

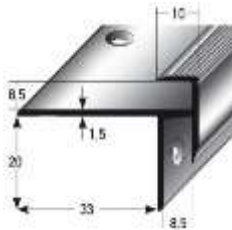

silberfarbig silver	1,0	29100-8	16,60	29101-5	17,60
	2,5	29110-7	41,56		
goldfarbig gold	1,0	29115-2	17,26	29111-4	44,54
	2,5	29125-1	43,20		
bronzef. hell bronze light	1,0	29130-5	18,64	29116-9	18,26
	2,5	29140-4	46,66		
bronzef. dunkel bronze dark	1,0	29145-9	18,64	29126-8	46,22
	2,5	29155-8	46,66		
gold hell gold light	1,0	62300-7	17,26	29131-2	19,66
	2,5	62310-6	43,20		
	1,0			29141-1	49,74
	2,5				
	1,0			29146-6	19,66
	2,5				
	1,0			29156-5	49,74
	2,5				
	1,0			62315-1	18,22
	2,5				
	1,0			62320-5	46,22
	2,5				

259 Treppenkante für Parkett 20 x 33 x 10 mm, Aluminium eloxiert, 2 x gebohrt

stair nosing for parquet
20 x 33 x 10 mm,
aluminium anodized, 2 x drilled

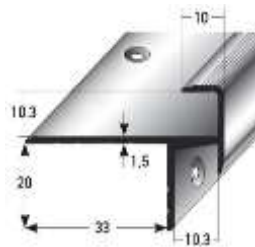

silberfarbig silver	1,0	46288-0	16,92	46292-7	17,90
	2,5	46290-3	42,30		
goldfarbig gold	1,0	46298-9	17,54	46294-1	45,34
	2,5	46300-9	43,80		
bronzef. hell bronze light	1,0	46308-5	18,98	46302-3	18,54
	2,5	46310-8	47,46		
bronzef. dunkel bronze dark	1,0	46318-4	18,98	46304-7	46,78
	2,5	46320-7	47,46		
gold hell gold light	1,0	46408-2	17,54	46312-2	19,98
	2,5	46410-5	43,80		
	1,0			46314-6	50,46
	2,5				
	1,0			46322-1	19,98
	2,5				
	1,0			46324-5	50,46
	2,5				
	1,0			46412-9	18,54
	2,5				
	1,0			46414-3	46,78
	2,5				

260 Treppenkante für Parkett 20 x 33 x 13 mm, Aluminium eloxiert, 2 x gebohrt

stair nosing for parquet
20 x 33 x 13 mm,
aluminium anodized, 2 x drilled

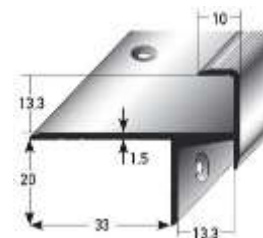

silberfarbig silver	1,0	46328-3	18,02	46332-0	19,02
	2,5	46330-6	45,00		
goldfarbig gold	1,0	46338-2	18,64	46334-4	48,06
	2,5	46340-5	46,66		
bronzef. hell bronze light	1,0	46348-1	20,20	46342-9	19,66
	2,5	46350-4	50,46		
bronzef. dunkel bronze dark	1,0	46358-0	20,20	46344-3	49,74
	2,5	46360-3	50,46		
gold hell gold light	1,0	46418-1	18,64	46352-8	21,20
	2,5	46420-4	46,66		
	1,0			46354-2	53,50
	2,5				
	1,0			46362-7	21,20
	2,5				
	1,0			46364-1	53,50
	2,5				
	1,0			46422-8	19,66
	2,5				
	1,0			46424-2	49,74
	2,5				

261 Treppenkante für Parkett 20 x 33 x 15 mm, Aluminium eloxiert, 2 x gebohrt

stair nosing for parquet
20 x 33 x 15 mm,
aluminium anodized,
2 x drilled

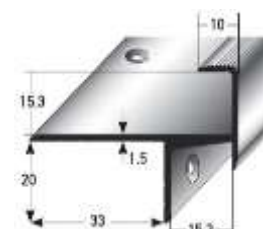

silberfarbig silver	1,0	46368-9	18,52	46372-6	19,46
	2,5	46370-2	46,22		
goldfarbig gold	1,0	46378-8	19,14	46374-0	49,26
	2,5	46380-1	47,86		
bronzef. hell bronze light	1,0	46388-7	20,22	46382-5	20,16
	2,5	46390-0	51,84		
bronzef. dunkel bronze dark	1,0	46398-6	20,22	46384-9	50,92
	2,5	46400-6	51,84		
gold hell gold light	1,0	46428-0	19,14	46392-4	21,78
	2,5	46430-3	47,86		
	1,0			46394-8	54,92
	2,5				
	1,0			46402-0	21,78
	2,5				
	1,0			46404-4	54,92
	2,5				
	1,0			46432-7	20,16
	2,5				
	1,0			46434-1	50,92
	2,5				

6. LED + SERVICE

6. LED + SERVICE



6. LED + SERVICE/ 6. LED + SERVICE

LED-beleuchtete Treppenkanten

LED-lighted stair nosings

Angebotserstellung erfolgt nach objektspezifischer Anfrage / offer only by object-specific request

Farbe & Material / colour+material

Art./ref.

309 Treppenkante 21 x 37 mm, für direkte Beleuchtung, Aluminum eloxiert, gebohrt

stair nosing 21x37 mm, for direct lighting, aluminum anodized, drilled

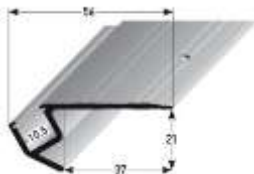

silberfarbig/ silver	47990-1
goldfarbig/ gold	47992-5
bronzefarbig hell/ bronze light	47994-9
bronzefarbig dunkel/ bronze dark	47996-3
edelstahlfarbig/ stainless steel coloured	47998-7

513 Treppenkante 40 x 45 mm, für indirekte Beleuchtung, Aluminum eloxiert, gebohrt

stair nosing 40x45 mm, for indirect lighting, aluminum anodized, drilled



silberfarbig/ silver	71754-6
goldfarbig/ gold	71756-0
bronzefarbig hell/ bronze light	71758-4
bronzefarbig dunkel/ bronze dark	71760-7
edelstahlfarbig/ stainless steel coloured	71762-1

Abdeckung zum Einschieben in die Treppenkante

cover to slide into the stair nosing

PVC-Rohr 10 x 10 mm PVC-pipe 10 x 10 mm	transparent/ transparent	48010-5
	rot/ red	48008-2
	grün/ green	48006-8
	gelb/ yellow	48002-0
PVC-Streifen 12 mm, transluzent / PVC-stripe 12 mm, translucent		71764-5

LED-Beleuchtungsstreifen

LED-lighting strip

12 V, warmweiß 10 LED/lfm. , alle 3 LED/ 25 cm teilbar/ 12 V, warm white 10 LED/m, every 3 LED/ 25 cm divisible	48014-3
12 V, warmweiß 30 LED/lfm. , selbstklebend, 8 mm breit, alle 3 LED/ 10 cm teilbar/ 12 V, warm white 30 LED/m, self-adhesive, 8 mm wide, every 3 LED/ 10 cm	48016-7
24 V, warmweiß ca. 500 LED/lfm. , selbstklebend, 10 mm breit, alle 4,2 cm teilbar/ 24 V, warm white, approx. 500 LED/m, self-adhesive, 10 mm wide, every 4,2 cm divisible	71966-3

Stromanschlussvarianten/ power connector variants

Die Wahl des Netzteils ist abhängig von den LED's.

Steckernetzteil 24 W / power supply 24 W	48026-6
Steckernetzteil 48 W / power supply 48 W	48028-0

The choice of the power supply depends also on the LED's.

Einbaunetzteil 12 W / built-in power supply 12 W	48030-3
Einbaunetzteil 60 W / built-in power supply 60 W	48032-7
Einbaunetzteil 100 W / built-in power supply 100 W	48034-1

Dienstleistung/ service

Rundum-Sorglos-Paket: wir liefern einbaufertig! Anschlusskabel gelötet, inkl. seitlicher Abdeckkappen All-round carefree package: we deliver ready-to-install! Connection cable soldered, including side caps	48038-9
---	---------

6. LED + SERVICE/ 6. LED + SERVICE

Sockelleisten mit LED-Beleuchtung

skirtings with LED lighting

Komponentenauswahl/ component selection:

Farbe/ colour	L / l (m)	Art./ref.	€/m
---------------	-----------	-----------	-----

514 Sockelleiste 60 mm, für indirekte LED-Beleuchtung, Aluminum eloxiert, ungebohrt

skirting 60 mm, for indirect LED lighting, aluminum anodized undrilled

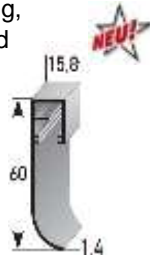

silberfarbig/ silver	2,5	71768-3	16,26/m
Pulverbeschichtet nach RAL9016 Verkehrsweiß/ powder RAL9016		73020-0	18,50/m
Pulvern nach RAL; Preis ab 150 lfm. powder RAL; price from 150 m	2,5	71770-6	19,54/m
		Pulvern nach RAL unter 150 lfm. auf Anfrage powdered (RAL) less than 150 m on request	

Sockelleiste mit 2 Kanälen: 1x für Stromversorgung + 1x für LED-Beleuchtung
skirting with 2 channels: 1x for power supply + 1x for LED lighting

515 Sockelleiste 100 mm, für indirekte LED-Beleuchtung, Aluminum eloxiert, ungebohrt

skirting 100 mm, for indirect LED lighting, aluminum anodized undrilled



silberfarbig/ silver	2,5	71774-4	21,52/m
Pulverbeschichtet nach RAL9016 Verkehrsweiß/ powder RAL9016		73022-4	23,28/m
Pulvern nach RAL; Preis ab 150 lfm. powder RAL; price from 150 m	2,5	71776-8	24,80/m
		Pulvern nach RAL unter 150 lfm. auf Anfrage powdered (RAL) less than 150 m on request	

Sockelleiste mit 2 Kanälen: 1x für Stromversorgung + 1x für LED-Beleuchtung
skirting with 2 channels: 1x for power supply + 1x for LED lighting

LED-Beleuchtungsstreifen selbstklebend LED lighting strip self-adhesive

12 V, warmweiß 30 LED/lfm. , 8 mm breit, alle 3 LED/ 10 cm teilbar 12 V, warm white 30 LED/m, 8 mm wide, every 3 LED/ 10 cm divisible	48016-7	Preis auf Anfrage price on request
24 V, warmweiß ca. 500 LED/lfm. , 10 mm breit, alle 4,2 cm teilbar 24 V, warm white, approx. 500 LED/m, 10 mm wide, every 4,2 cm divisible	71966-3	

Eckverbinder für LED-Streifen LED corner connector

4-poliger Eckverbinder für 8 und 10 mm breite LED-Streifen 4-pole corner connector for 8 and 10 mm wide LED strips	71860-4	Preis auf Anfrage price on request
--	---------	---------------------------------------

Kühlstreifen 10 x 1 mm cooling strips 10 x 1 mm

optional zum Aufkleben der LEDs, 1,0 m optional for gluing the LEDs, 1,0 m	71864-2	1,44/m
---	---------	--------

transluzente Abdeckung zum Einschieben translucent cover to slide in

PVC-Streifen 12 mm, transluzent, Rolle à 25 m PVC-stripe 12 mm, translucent, roll a 25 m	71764-5	2,72/m 67,50 €/Ro.
---	---------	-----------------------

Für Zuschnitte erheben wir einen Arbeitsaufschlag von 15 %.
For cuttings we charge a labor surcharge of 15%.

Stromanschlussvarianten/ power connector variants

Die Wahl des Netzteils ist abhängig von der LED-Streifenlänge.
The choice of the power supply depends from the LED strip length.

Steckernetzteil 24 W / power supply 24 W	48026-6	Preis auf Anfrage price on request
Steckernetzteil 48 W / power supply 48 W	48028-0	
Einbaunetzteil 12 W / built-in power supply 12 W	48030-3	
Einbaunetzteil 60 W / built-in power supply 60 W	48032-7	
Einbaunetzteil 100 W / built-in power supply 100 W	48034-1	

6. LED + SERVICE/ 6. LED + SERVICE

Serviceleistungen für unsere Kunden/ services for our customers

☞ Sonderlängenzuschnitt, Längsteilen von Profilen, Profile ohne Bohrungen oder pressblank, Sonderbohrungen (Durchmesser + Bohrbilder + Lochabstand) auf Anfrage möglich
special length cuts, lengthwise cutting of profiles, profiles without holes or mill finish and special drilling (diameter / drilling patterns / hole spacing)

☞ andere Farben und Oberflächen auf Anfrage:
andere Eloxalfarben (gold hell, schwarz, edelstahlfarbig), Pulverbeschichten nach RAL, Emaillieren, Brünieren, Vergolden, Zaponlackieren
other colours and surfaces on request:
other anodized colours (gold light, black, stainless steel coloured), powder coating according to RAL, enamelling, brass burnished, gilding, zapon varnishing

☞ Mattschleifen, Anfasen, Gehrungsschnitte, Rahmenfertigung, Profillfertigung nach Skizze, Laserbearbeitung von Edelstahl, Messing, Aluminium und Kupfer, Laserschweißen
matt grinding, chamfering, miter cuts, frame production, profile production according to sketch, laser processing of stainless steel, brass, aluminum and copper, laser welding

☞ Biegen von Profilen nach Schablone oder Radiusangabe (nach vorheriger Absprache)
bending of profiles with template or radius specification (by prior arrangement)

☞ Einschweißen von Profilen / profiles shrink-wrapped in foil

und vieles mehr / and much more

Technische Datenblätter, Verlegehinweise, Materialbeschreibungen & Pflegehinweise erhalten Sie gern auf Anfrage oder unter www.Auer-Metallprofile.de

Technical details, installation tips, material descriptions and care instructions are available on request
or under www.Auer-metallprofile.de



Beispiel: Winkelprofil aus Aluminium, gebogen
example: aluminium angle edge bent

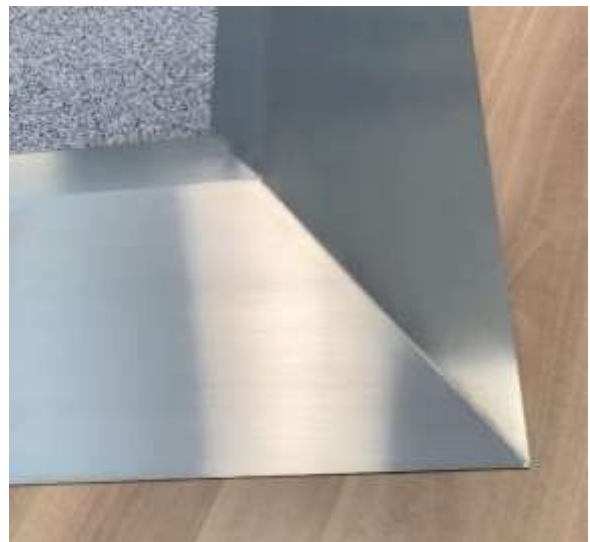

Beispiel: Edelstahl-Niveauequalisierungsecke, feingeschweißt
Example: stainless steel level compensation corner, finely welded

6. LED + SERVICE/ 6. LED + SERVICE

Serviceleistungen für unsere Kunden/ services for our customers

Profil ungebohrt erhalten
 get the profile undrilled



Diese Artnr. zusammen mit der jeweiligen Profilartikelnummer angeben!
 Please specify this article number together with the profile article number!

Art./ref.
22291-0

Befestigungsschenkel ausklinken
 attachment flanges notched

Art./ref.	€/m
22240-8	7,16

zusätzlich zum Materialpreis/ in addition to the material price



Profile können in Radien größer als ca. 3,0 m vor Ort gebogen werden.
 Profiles with radius larger than 3,0 m can be bent at installation location.

doppelte Anzahl Bohrlöcher /
 twice the number of drill holes

Von Profil zu Profil können große Unterschiede in der Biegefähigkeit bestehen.
 There may be substantial variations in the possibility of bending different profiles.

Befestigungsschenkel ausklinken und biegen
 attachment flanges notched and bent



Befestigungsschenkel für alle gängigen Einfass- und Einschubprofile ausklinken und Profil biegen nach Schablone, Skizze oder Radius.

Attachment flanges for all common insert profiles notched and bent according to template, sketch or radius.



Bitte immer die Biegerichtung mit angeben!

Please specify the bending direction!

Art./ref.	€/Radius/radius
22241-5	193,72

zusätzlich zum Materialpreis/ in addition to the material price

Die Aufbewahrungsfrist für Schablonen in Aue beträgt maximal 6 Monate!
 Important: We keep templates in Aue for a max. of 6 months!

Achtung!! Bei Winkel- und Übergangprofilen kann der Biegeaufwand höher sein. Bitte extra anfragen!

Attention! For angles and connecting profiles the bending effort can be higher.
 Please inquire separately!

251 Säulenringe biegen

pillar ring bent



Abbildung nur symbolhaft
 illustration only symbolic

zusätzlich zum Materialpreis/ in addition to the material price

Ø mm	Art./ref.	€/Ring/pillar ring
Ø 200-300	45720-6	105,40
Ø 301-400	45725-1	97,56
Ø 401-500	45730-5	89,70
Ø 501-X	45735-0	89,70

Fertigung in 2 Halbschalen/ manufactured in two halves

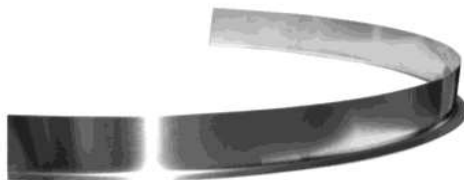
Dehnungsfugenprofil gebogen
 expansion gap profile, bent



Einschubprofil mit Nase aus Edelstahl, gebogen
 stainless steel nosed insert profile, bent

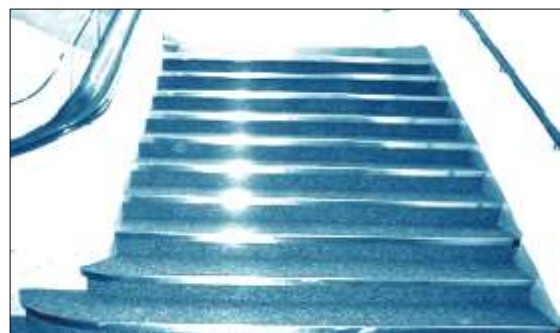

Übergangprofil gebogen/ connecting profile curved

7. SYSTEMPROFILE AUS ALUMINIUM & EDELSTAHL FÜR 4-24mm BELÄGE

7. SYSTEM PROFILES OUT OF ALUMINIUM + STAINLESS STEEL
FOR 4-24mm FLOORINGS

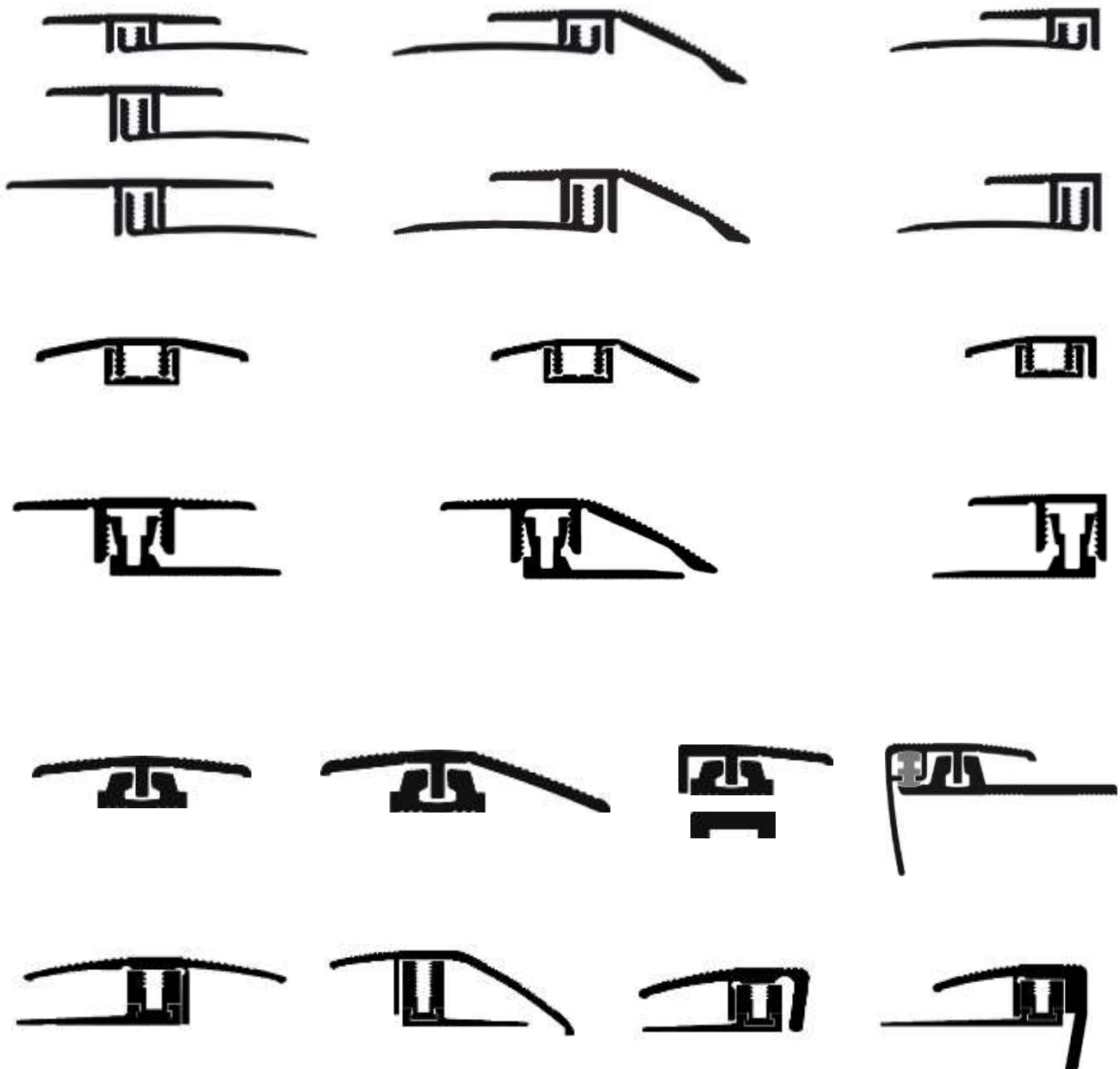

7. SYSTEMPROFILE FÜR 4-24mm BELÄGE/ 7. PROFILES FOR 4-24mm FLOORINGS

MINI-APL-System 5 - 9 mm, 2-teilig

MINI-APL-system 5 - 9 mm, 2 parts

306 **MINI-APL-Übergangprofil**
5 - 9 mm, Aluminium, gebohrt,
mit 40 mm breitem Grundprofil

MINI-APL-edge 5 - 9 mm, aluminium,
drilled, with 40 mm wide basic profile



Zusätzliche Schrauben siehe Abschnitt 12.
Additional screws, see section 12.

SB-Pack inkl. Schrauben + Dübel; VE 20 Stk.

self-service-pack with screws + dowels; à 20 pcs.

Farbe/colour	L / l (m)	Art./ref.	€/Stk./pcs.
silberfarbig silver	0,9	48776-0	18,76
	1,0	48778-4	20,84
	2,7	48780-7	56,26
goldfarbig gold	0,9	48782-1	18,94
	1,0	48784-5	21,02
	2,7	48786-9	56,76
bronzef. hell bronze light	0,9	48788-3	19,84
	1,0	48790-6	22,04
	2,7	48792-0	59,56
bronzef. dunkel bronze dark	0,9	48794-4	19,84
	1,0	48796-8	22,04
	2,7	48798-2	59,56
gold hell gold light	0,9	48800-2	18,94
	1,0	48802-6	21,02
	2,7	48804-0	56,76
edelstahlfarbig stainless steel coloured	0,9	48806-4	19,84
	1,0	48808-8	22,04
	2,7	48810-1	59,56

APL-System 7 - 15 mm, 2-teilig

APL-system 7 - 15 mm, 2 parts

255 **APL-Übergangprofil**
7 - 15 mm, Aluminium, gebohrt,
mit 40 mm breitem Grundprofil

APL-edge 7 - 15 mm, aluminium,
drilled, with 40 mm wide basic profile

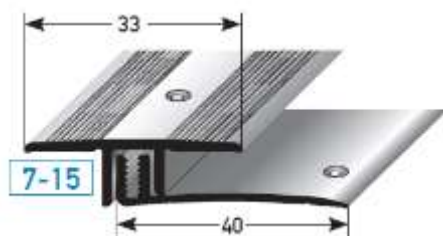

Zusätzliche Schrauben siehe Abschnitt 12.
Additional screws, see section 12.

Grundprofilerhöhung
siehe Seite 99

basic profile increase
see page 99

SB-Pack inkl. Schrauben + Dübel; VE 20 Stk.

self-service-pack with screws + dowels; à 20 pcs.

Farbe/colour	L / l (m)	Art./ref.	€/Stk./pcs.
silberfarbig silver	0,9	45944-6	17,24
	1,0	45824-1	19,14
	2,7	45800-5	51,70
goldfarbig gold	0,9	45946-0	17,36
	1,0	45826-5	19,34
	2,7	45802-9	52,20
bronzef. hell bronze light	0,9	45950-7	18,32
	1,0	45830-2	20,36
	2,7	45806-7	54,98
bronzef. dunkel bronze dark	0,9	45952-1	18,32
	1,0	45832-6	20,36
	2,7	45808-1	54,98
gold hell gold light	0,9	45948-4	17,36
	1,0	45828-9	19,34
	2,7	45804-3	52,20
edelstahlfarbig stainless steel coloured	0,9	45964-4	18,32
	1,0	45844-9	20,36
	2,7	45820-3	54,98
Buche beech	0,9	45954-5	23,58
	1,0	45834-0	26,20
	2,7	45810-4	70,70
Eiche oak	0,9	45956-9	23,58
	1,0	45836-4	26,20
	2,7	45812-8	70,70
Ahorn maple	0,9	45958-3	23,58
	1,0	45838-8	26,20
	2,7	45814-2	70,70
Kirschbaum cherry wood	0,9	45960-6	23,58
	1,0	45840-1	26,20
	2,7	45816-6	70,70
Eiche rustikal rustic oak	0,9	45962-0	23,58
	1,0	45842-5	26,20
	2,7	45818-0	70,70

Holzdekorfolie/ wood decor

7. SYSTEMPROFILE FÜR 4-24mm BELÄGE/ 7. PROFILES FOR 4-24mm FLOORINGS

APL-System 7 - 15 mm, 2-teilig

APL-system 7 - 15 mm, 2 parts

499

APL-Übergangprofil
50 mm extrabreit, 7 - 15 mm,
Aluminium, gebohrt,
mit 40 mm breitem Grundprofil

APL-edge extra wide, 7 - 15 mm,
aluminium, drilled, with 40 mm wide
basic profile

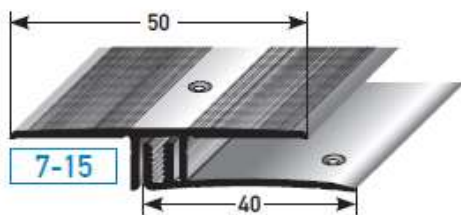

Zusätzliche Schrauben siehe Abschnitt 12.
Additional screws, see section 12.

SB-Pack inkl. Schrauben + Dübel; VE 20 Stk.

self-service-pack with screws + dowels; à 20 pcs.

Farbe/colour	L / l (m)	Art./ref.	€/Stk./pcs.
silberfarbig silver	0,9	71356-2	18,14
	1,0	71358-6	20,12
	2,7	71360-9	54,34
goldfarbig gold	0,9	71362-3	18,52
	1,0	71364-7	20,54
	2,7	71366-1	55,44
bronzef. hell bronze light	0,9	71368-5	19,90
	1,0	71370-8	22,12
	2,7	71372-2	59,66
bronzef. dunkel bronze dark	0,9	71374-6	19,90
	1,0	71376-0	22,12
	2,7	71378-4	59,66
gold hell gold light	0,9	71380-7	18,52
	1,0	71382-1	20,54
	2,7	71384-5	55,44
edelstahlfarbig stainless steel coloured	0,9	71386-9	19,90
	1,0	71388-3	22,12
	2,7	71390-6	59,66

516

20 mm breites MINI-APL-Grundprofil für 5 - 9 mm Beläge, Aluminium, gebohrt

ohne Schrauben/ Dübel

20 mm wide MINI-APL-basic profile, for 5-9 mm flooring,
aluminium, drilled, without screws/ dowels

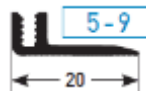

L / l (m)	Art./ref.	€/Stk./pcs.
0,9	71788-1	4,60
1,0	71790-4	5,10
2,7	71792-8	13,76

517

20 mm breites APL-Grundprofil für 7 - 15 mm Beläge, Aluminium, gebohrt

ohne Schrauben/ Dübel

20 mm wide APL-basic profile, for 7-15 mm flooring,
aluminium, drilled, without screws/ dowels

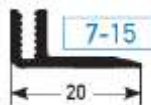

L / l (m)	Art./ref.	€/Stk./pcs.
0,9	71780-5	5,32
1,0	71782-9	5,90
2,7	71784-3	15,92

498

Grundprofilerhöhung für APL- & SLP-System, PLA-3D, 2x gebohrt, inkl. Schrauben

basic profile increase for APL and SLP
system, PLA-3D, 2x drilled, including
screws



Höhe in mm height in mm	VE/unit	Art./ref.	€/Stk./pcs.
5	10	71796-6	1,96
8		71798-0	2,22
11		71800-0	2,46

7. SYSTEMPROFILE FÜR 4-24mm BELÄGE/ 7. PROFILES FOR 4-24mm FLOORINGS

MINI-APL-System 5 - 9 mm, 2-teilig

MINI-APL-system 5 - 9 mm, 2 parts

307

MINI-APL-Höhenausgleichsprofil
 5 - 9 mm, Aluminium, gebohrt,
 mit 40 mm breites Grundprofil

MINI-APL-height levelling 5 - 9 mm, aluminium,
 drilled, with 40 mm wide basic profile

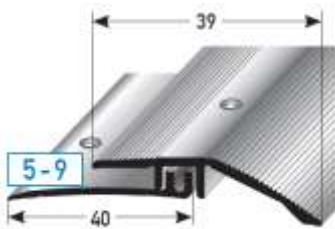

Zusätzliche Schrauben siehe Abschnitt 12.
 Additional screws, see section 12.

SB-Pack inkl. Schrauben + Dübel; VE 20 Stk.

self-service-pack with screws + dowels; à 20 pcs.

Farbe/colour	L / l (m)	Art./ref.	€/Stk./pcs.
silberfarbig silver	0,9	48856-9	21,40
	1,0	48858-3	23,76
	2,7	48860-6	64,20
goldfarbig gold	0,9	48862-0	21,44
	1,0	48864-4	23,84
	2,7	48866-8	64,38
bronzef. hell bronze light	0,9	48868-2	22,62
	1,0	48870-5	25,18
	2,7	48872-9	67,94
bronzef. dunkel bronze dark	0,9	48874-3	22,62
	1,0	48876-7	25,18
	2,7	48878-1	67,94
gold hell gold light	0,9	48880-4	21,44
	1,0	48882-8	23,84
	2,7	48884-2	64,38
edelstahlfarbig stainless steel coloured	0,9	48886-6	22,62
	1,0	48888-0	25,18
	2,7	48890-3	67,94

APL-System 7 - 15 mm, 2-teilig

APL-system 7 - 15 mm, 2 parts

256

APL-Höhenausgleichsprofil
 7 - 15 mm, Aluminium, gebohrt,
 mit 40 mm breitem Grundprofil

APL-height levelling 7 - 15 mm, aluminium,
 drilled, with 40 mm wide basic profile

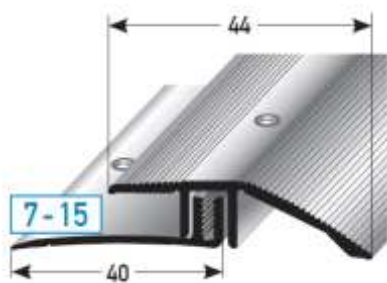

Zusätzliche Schrauben siehe Abschnitt 12.
 Additional screws, see section 12.

SB-Pack inkl. Schrauben + Dübel; VE 20 Stk.

self-service-pack with screws + dowels; à 20 pcs.

Farbe/colour	L / l (m)	Art./ref.	€/Stk./pcs.
silberfarbig silver	0,9	45966-8	19,86
	1,0	45872-2	22,06
	2,7	45848-7	59,58
goldfarbig gold	0,9	45968-2	19,96
	1,0	45874-6	22,14
	2,7	45850-0	59,82
bronzef. hell bronze light	0,9	45972-9	21,14
	1,0	45878-4	23,46
	2,7	45854-8	63,38
bronzef. dunkel bronze dark	0,9	45974-3	21,14
	1,0	45880-7	23,46
	2,7	45856-2	63,38
gold hell gold light	0,9	45970-5	19,96
	1,0	45876-0	22,14
	2,7	45852-4	59,82
edelstahlfarbig stainless steel coloured	0,9	45986-6	21,14
	1,0	45892-0	23,46
	2,7	45868-5	63,38

Holzdekorfolie/ wood decor

Buche beech	0,9	45976-7	26,22
	1,0	45882-1	29,10
	2,7	45858-6	78,58
Eiche oak	0,9	45978-1	26,22
	1,0	45884-5	29,10
	2,7	45860-9	78,58
Ahorn maple	0,9	45980-4	26,22
	1,0	45886-9	29,10
	2,7	45862-3	78,58
Kirschbaum cherry wood	0,9	45982-8	26,22
	1,0	45888-3	29,10
	2,7	45864-7	78,58
Eiche rustikal rustic oak	0,9	45984-2	26,22
	1,0	45890-6	29,10
	2,7	45866-1	78,58

**Grundprofilerhöhung
 siehe Seite 99**

basic profile increase
 see page 99

7. SYSTEMPROFILE FÜR 4-24mm BELÄGE/ 7. PROFILES FOR 4-24mm FLOORINGS

MINI-APL-System 5 - 9 mm, 2-teilig

MINI-APL-system 5 - 9 mm, 2 parts

308

MINI-APL-Abschlussprofil
5 - 9 mm, Aluminium, gebohrt,
mit 40 mm breites Grundprofil

MINI-APL-end 5 - 9 mm, aluminium, drilled,
with 40 mm wide basic profile

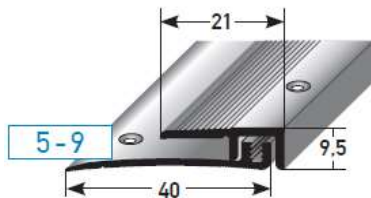

Zusätzliche Schrauben siehe Abschnitt 12.
Additional screws, see section 12.

SB-Pack inkl. Schrauben + Dübel; VE 20 Stk.

self-service-pack with screws + dowels; à 20 pcs.

Farbe/colour	L / l (m)	Art./ref.	€/Stk./pcs.
silberfarbig silver	0,9	48936-8	17,44
	1,0	48938-2	19,36
	2,7	48940-5	52,32
goldfarbig gold	0,9	48942-9	17,54
	1,0	48944-3	19,46
	2,7	48946-7	52,58
bronzef. hell bronze light	0,9	48948-1	18,52
	1,0	48950-4	20,54
	2,7	48952-8	55,52
bronzef. dunkel bronze dark	0,9	48954-2	18,52
	1,0	48956-6	20,54
	2,7	48958-0	55,52
gold hell gold light	0,9	48960-3	17,54
	1,0	48962-7	19,46
	2,7	48964-1	52,58
edelstahlfarbig stainless steel coloured	0,9	48966-5	18,52
	1,0	48968-9	20,54
	2,7	48970-2	55,52

APL-System 7 - 15 mm, 2-teilig

APL-system 7 - 15 mm, 2 parts

257

APL-Abschlussprofil
7 - 15 mm, Aluminium, gebohrt,
mit 40 mm breites Grundprofil

APL-end 7 - 15 mm, aluminium, drilled,
with 40 mm wide basic profile

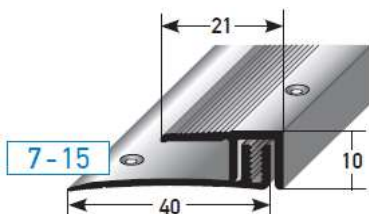

Zusätzliche Schrauben siehe Abschnitt 12.
Additional screws, see section 12.

SB-Pack inkl. Schrauben + Dübel; VE 20 Stk.

self-service-pack with screws + dowels; à 20 pcs.

Farbe/colour	L / l (m)	Art./ref.	€/Stk./pcs.
silberfarbig silver	0,9	45988-0	15,92
	1,0	45920-0	17,70
	2,7	45896-8	47,72
goldfarbig gold	0,9	45990-3	16,02
	1,0	45922-4	17,80
	2,7	45898-2	48,04
bronzef. hell bronze light	0,9	45994-1	16,96
	1,0	45926-2	18,88
	2,7	45902-6	50,92
bronzef. dunkel bronze dark	0,9	45996-5	16,96
	1,0	45928-6	18,88
	2,7	45904-0	50,92
gold hell gold light	0,9	45992-7	16,02
	1,0	45924-8	17,80
	2,7	45900-2	48,04
edelstahlfarbig stainless steel coloured	0,9	46008-4	16,96
	1,0	45940-8	18,88
	2,7	45916-3	50,92
Buche beech	0,9	45998-9	22,22
	1,0	45930-9	24,66
	2,7	45906-4	66,66
Eiche oak	0,9	46000-8	22,22
	1,0	45932-3	24,66
	2,7	45908-8	66,66
Ahorn maple	0,9	46002-2	22,22
	1,0	45934-7	24,66
	2,7	45910-1	66,66
Kirschbaum cherry wood	0,9	46004-6	22,22
	1,0	45936-1	24,66
	2,7	45912-5	66,66
Eiche rustikal rustic oak	0,9	46006-0	22,22
	1,0	45938-5	24,66
	2,7	45914-9	66,66

Holzdekorfolie/ wood decor

7. SYSTEMPROFILE FÜR 4-24mm BELÄGE/ 7. PROFILES FOR 4-24mm FLOORINGS

MINI-APL-KLICK-System 4-7 mm, 2-teilig

MINI-APL-CLICK-system 4-7 mm, 2-teilig/ 2 parts

447 MINI-APL-Klick-Übergangprofil

4 - 7 mm, zum Klicken,
Aluminium

MINI-APL-click-edge 4 - 7 mm, to click,
aluminium

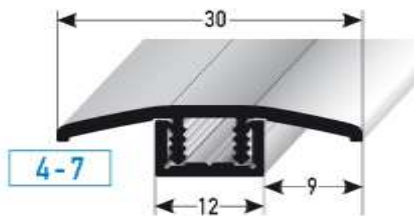

SB-Pack inkl. Schrauben + Dübel; VE 20 Stk.			
self-service-pack with screws + dowels; à 20 pcs.			
Farbe/colour	L / l (m)	Art./ref.	€/Stk./pcs.
silberfarbig silver	0,9	68396-4	16,00
	1,0	68398-8	17,78
	2,7	68400-8	48,02
goldfarbig gold	0,9	68402-2	16,44
	1,0	68404-6	18,26
	2,7	68406-0	49,34
bronzef. hell bronze light	0,9	68408-4	17,86
	1,0	68410-7	19,86
	2,7	68412-1	53,64
bronzef. dunkel bronze dark	0,9	68414-5	17,86
	1,0	68416-9	19,86
	2,7	68418-3	53,64
gold hell gold light	0,9	68420-6	16,44
	1,0	68422-0	18,26
	2,7	68424-4	49,34
edelstahlfarbig/ AL-INOX stainless steel coloured	0,9	68426-8	17,86
	1,0	68428-2	19,86
	2,7	68430-5	53,64

APL-KLICK-System 7-10 mm, 2-teilig

APL-CLICK-system 7-10 mm, 2-teilig/ 2 parts

272 APL-Klick-Übergangprofil

7 - 10 mm, zum Klicken,
Aluminium

APL-click-edge 7 - 10 mm, to click,
aluminium

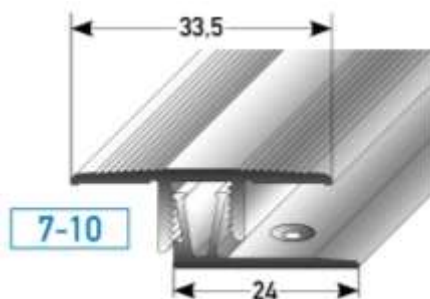

SB-Pack inkl. Schrauben + Dübel; VE 20 Stk.			
self-service-pack with screws + dowels; à 20 pcs.			
Farbe/colour	L / l (m)	Art./ref.	€/Stk./pcs.
silberfarbig silver	0,9	48300-7	17,12
	1,0	48302-1	19,02
	2,7	48304-5	51,32
goldfarbig gold	0,9	48306-9	17,26
	1,0	48308-3	19,16
	2,7	48310-6	51,78
bronzef. hell bronze light	0,9	48312-0	18,18
	1,0	48314-4	20,22
	2,7	48316-8	54,56
bronzef. dunkel bronze dark	0,9	48318-2	18,18
	1,0	48320-5	20,22
	2,7	48322-9	54,56
gold hell gold light	0,9	48324-3	17,26
	1,0	48326-7	19,16
	2,7	48328-1	51,78
edelstahlfarbig/ AL-INOX stainless steel coloured	0,9	48330-4	18,18
	1,0	48332-8	20,22
	2,7	48334-2	54,56
Buche beech	0,9	48336-6	23,44
	1,0	48338-0	26,04
	2,7	48340-3	70,34
Eiche oak	0,9	48342-7	23,44
	1,0	48344-1	26,04
	2,7	48346-5	70,34
Ahorn maple	0,9	48348-9	23,44
	1,0	48350-2	26,04
	2,7	48352-6	70,34
Kirschbaum cherry wood	0,9	48354-0	23,44
	1,0	48356-4	26,04
	2,7	48358-8	70,34
Eiche rustikal rustic oak	0,9	48360-1	23,44
	1,0	48362-5	26,04
	2,7	48364-9	70,34

Für 7-10 mm-Beläge + 2 mm Dämmung
for 7-10 mm coverings + 2 mm insulation

Holzdekorfolie/ wood decor

7. SYSTEMPROFILE FÜR 4-24mm BELÄGE/ 7. PROFILES FOR 4-24mm FLOORINGS

APL-KLICK-System 11-15 mm, 2-teilig

APL-CLICK-system 11-15 mm, 2 parts

273

APL-Klick-Übergangprofil

**11 - 15 mm, zum Klicken,
Aluminium**

APL-click-edge 11 - 15 mm, to click,
aluminium



Für 11-15 mm-Beläge + 2 mm Dämmung
for 11-15 mm coverings + 2 mm insulation

SB-Pack inkl. Schrauben + Dübel; VE 20 Stk.			
self-service-pack with screws + dowels; à 20 pcs.			
Farbe/colour	L / l (m)	Art./ref.	€/Stk./pcs.
silberfarbig silver	0,9	48378-6	18,18
	1,0	48380-9	20,22
	2,7	48382-3	54,56
goldfarbig gold	0,9	48384-7	18,34
	1,0	48386-1	20,38
	2,7	48388-5	55,04
bronzef. hell bronze light	0,9	48390-8	19,26
	1,0	48392-2	21,42
	2,7	48394-6	57,84
bronzef. dunkel bronze dark	0,9	48396-0	19,26
	1,0	48398-4	21,42
	2,7	48400-4	57,84
gold hell gold light	0,9	48402-8	18,34
	1,0	48404-2	20,38
	2,7	48406-6	55,04
edelstahlfarbig/ AL- INOX stainless steel coloured	0,9	48408-0	19,26
	1,0	48410-3	21,42
	2,7	48412-7	57,84
Buche beech	0,9	48414-1	24,54
	1,0	48416-5	27,26
	2,7	48418-9	73,60
Eiche oak	0,9	48420-2	24,54
	1,0	48422-6	27,26
	2,7	48424-0	73,60
Ahorn maple	0,9	48426-4	24,54
	1,0	48428-8	27,26
	2,7	48430-1	73,60
Kirschbaum cherry wood	0,9	48432-5	24,54
	1,0	48434-9	27,26
	2,7	48436-3	73,60
Eiche rustikal rustic oak	0,9	48438-7	24,54
	1,0	48440-0	27,26
	2,7	48442-4	73,60

Holzdekorfolie/ wood decor

APL-KLICK-System 15-24 mm, 2-teilig

APL-CLICK-system 15-24 mm, 2 parts

448

APL-Klick-Übergangprofil

**15 - 24 mm, zum Klicken,
Aluminium**

APL-click-edge 15 - 24 mm, to click,
aluminium

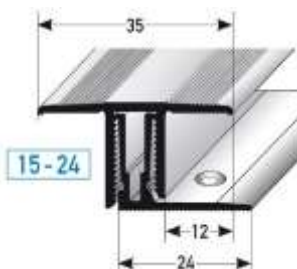

Für 15-24 mm-Beläge + 2 mm Dämmung
for 15-24 mm coverings + 2 mm insulation

SB-Pack inkl. Schrauben + Dübel; VE 20 Stk.			
self-service-pack with screws + dowels; à 20 pcs.			
Farbe/colour	L / l (m)	Art./ref.	€/Stk./pcs.
silberfarbig silver	0,9	68440-4	22,66
	1,0	68442-8	25,20
	2,7	68444-2	68,04
goldfarbig gold	0,9	68446-6	22,82
	1,0	68448-0	25,36
	2,7	68450-3	68,46
bronzef. hell bronze light	0,9	68452-7	24,06
	1,0	68454-1	26,76
	2,7	68456-5	72,20
bronzef. dunkel bronze dark	0,9	68458-9	24,06
	1,0	68460-2	26,76
	2,7	68462-6	72,20
gold hell gold light	0,9	68464-0	22,82
	1,0	68466-4	25,36
	2,7	68468-8	68,46
edelstahlfarbig/ AL- INOX stainless steel coloured	0,9	68470-1	24,06
	1,0	68472-5	26,76
	2,7	68474-9	72,20

7. SYSTEMPROFILE FÜR 4-24mm BELÄGE/ 7. PROFILES FOR 4-24mm FLOORINGS

MINI-APL-KLICK-System 4-7 mm, 2-teilig

MINI-APL-CLICK-system 4-7 mm, 2 parts

449 **MINI-APL-Klick-Höhenausgleichsprofil**
4 - 7 mm, zum Klicken, Aluminium

MINI-APL-click-height levelling 4 - 7 mm, to click, aluminium

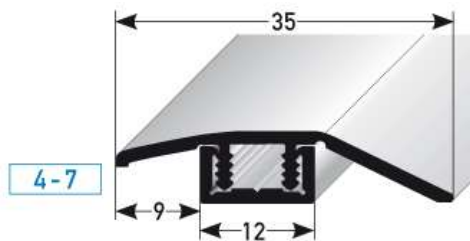

SB-Pack inkl. Schrauben + Dübel; VE 20 Stk. self-service-pack with screws + dowels; à 20 pcs.			
Farbe/colour	L / l (m)	Art./ref.	€/Stk./pcs.
silberfarbig silver	0,9	68484-8	16,64
	1,0	68486-2	18,54
	2,7	68488-6	49,96
goldfarbig gold	0,9	68490-9	17,14
	1,0	68492-3	19,02
	2,7	68494-7	51,34
bronzef. hell bronze light	0,9	68496-1	18,64
	1,0	68498-5	20,74
	2,7	68500-5	55,94
bronzef. dunkel bronze dark	0,9	68502-9	18,64
	1,0	68504-3	20,74
	2,7	68506-7	55,94
gold hell gold light	0,9	68508-1	17,14
	1,0	68510-4	19,02
	2,7	68512-8	51,34
edelstahlfarbig/ AL-INOX stainless steel coloured	0,9	68514-2	18,64
	1,0	68516-6	20,74
	2,7	68518-0	55,94

APL-KLICK-System 7-10 mm, 2-teilig

APL-CLICK-system 7-10 mm, 2 parts

274 **APL-Klick-Höhenausgleichsprofil**
7 - 10 mm, zum Klicken, Aluminium

APL-click-height levelling 7 - 10 mm, to click, aluminium

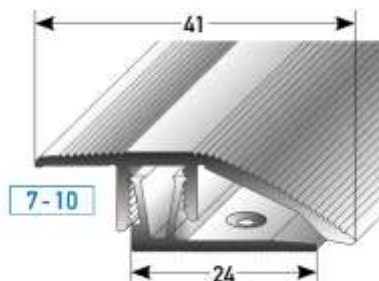

SB-Pack inkl. Schrauben + Dübel; VE 20 Stk. self-service-pack with screws + dowels; à 20 pcs.			
Farbe/colour	L / l (m)	Art./ref.	€/Stk./pcs.
silberfarbig silver	0,9	48458-5	19,78
	1,0	48460-8	21,94
	2,7	48462-2	59,26
goldfarbig gold	0,9	48464-6	19,80
	1,0	48466-0	22,00
	2,7	48468-4	59,38
bronzef. hell bronze light	0,9	48470-7	20,98
	1,0	48472-1	23,34
	2,7	48474-5	62,98
bronzef. dunkel bronze dark	0,9	48476-9	20,98
	1,0	48478-3	23,34
	2,7	48480-6	62,98
gold hell gold light	0,9	48482-0	19,80
	1,0	48484-4	22,00
	2,7	48486-8	59,38
edelstahlfarbig/ AL-INOX stainless steel coloured	0,9	48488-2	20,98
	1,0	48490-5	23,34
	2,7	48492-9	62,98
Buche beech	0,9	48494-3	26,04
	1,0	48496-7	28,98
	2,7	48498-1	78,16
Eiche oak	0,9	48500-1	26,04
	1,0	48502-5	28,98
	2,7	48504-9	78,16
Ahorn maple	0,9	48506-3	26,04
	1,0	48508-7	28,98
	2,7	48510-0	78,16
Kirschbaum cherry wood	0,9	48512-4	26,04
	1,0	48514-8	28,98
	2,7	48516-2	78,16
Eiche rustikal rustic oak	0,9	48518-6	26,04
	1,0	48520-9	28,98
	2,7	48522-3	78,16

Für 7-10 mm-Beläge + 2 mm Dämmung
for 7-10 mm coverings + 2 mm insulation

Holzdekorfolie/ wood decor

7. SYSTEMPROFILE FÜR 4-24mm BELÄGE/ 7. PROFILES FOR 4-24mm FLOORINGS

APL-KLICK-System 11-15 mm, 2-teilig

APL-CLICK-system 11-15 mm, 2 parts

275

**APL-Klick-
Höhenausgleichsprofil**
11 - 15 mm, zum Klicken,
Aluminium

APL-click-height levelling 11 - 15 mm, to click, aluminium



Für 11-15 mm-Beläge + 2 mm Dämmung
for 11-15 mm coverings + 2 mm insulation

SB-Pack inkl. Schrauben + Dübel; VE 20 Stk.			
self-service-pack with screws + dowels; à 20 pcs.			
Farbe/colour	L / l (m)	Art./ref.	€/Stk./pcs.
silberfarbig silver	0,9	48536-0	20,84
	1,0	48538-4	23,14
	2,7	48540-7	62,52
goldfarbig gold	0,9	48542-1	20,86
	1,0	48544-5	23,20
	2,7	48546-9	62,66
bronzef. hell bronze light	0,9	48548-3	22,06
	1,0	48550-6	24,54
	2,7	48552-0	66,26
bronzef. dunkel bronze dark	0,9	48554-4	22,06
	1,0	48556-8	24,54
	2,7	48558-2	66,26
gold hell gold light	0,9	48560-5	20,86
	1,0	48562-9	23,20
	2,7	48564-3	62,66
edelstahlfarbig/ AL-INOX stainless steel coloured	0,9	48566-7	22,06
	1,0	48568-1	24,54
	2,7	48570-4	66,26
Buche beech	0,9	48572-8	27,30
	1,0	48574-2	30,32
	2,7	48576-6	81,82
Eiche oak	0,9	48578-0	27,30
	1,0	48580-3	30,32
	2,7	48582-7	81,82
Ahorn maple	0,9	48584-1	27,30
	1,0	48586-5	30,32
	2,7	48588-9	81,82
Kirschbaum cherry wood	0,9	48590-2	27,30
	1,0	48592-6	30,32
	2,7	48594-0	81,82
Eiche rustikal rustic oak	0,9	48596-4	27,30
	1,0	48598-8	30,32
	2,7	48600-8	81,82

Holzdekorfolie/ wood decor

APL-KLICK-System 15-24 mm, 2-teilig

APL-CLICK-system 15-24 mm, 2 parts

450

**APL-Klick-
Höhenausgleichsprofil**
15 - 24 mm, zum Klicken, Aluminium

APL-click-height levelling 15 - 24 mm, to click, aluminium

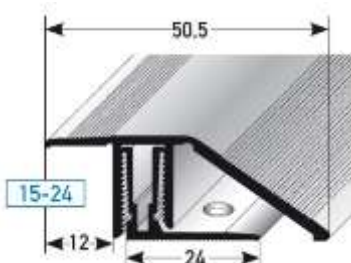

Für 15-24 mm-Beläge + 2 mm Dämmung
for 15-24 mm coverings + 2 mm insulation

SB-Pack inkl. Schrauben + Dübel; VE 20 Stk.			
self-service-pack with screws + dowels; à 20 pcs.			
Farbe/colour	L / l (m)	Art./ref.	€/Stk./pcs.
silberfarbig silver	0,9	68528-9	27,78
	1,0	68530-2	30,90
	2,7	68532-6	83,40
goldfarbig gold	0,9	68534-0	27,84
	1,0	68536-4	30,94
	2,7	68538-8	83,54
bronzef. hell bronze light	0,9	68540-1	29,52
	1,0	68542-5	32,78
	2,7	68544-9	88,58
bronzef. dunkel bronze dark	0,9	68546-3	29,52
	1,0	68548-7	32,78
	2,7	68550-0	88,58
gold hell gold light	0,9	68552-4	27,84
	1,0	68554-8	30,94
	2,7	68556-2	83,54
edelstahlfarbig/ AL-INOX stainless steel coloured	0,9	68558-6	29,52
	1,0	68560-9	32,78
	2,7	68562-3	88,58

7. SYSTEMPROFILE FÜR 4-24mm BELÄGE/ 7. PROFILES FOR 4-24mm FLOORINGS

MINI-APL-KLICK-System 4-7 mm, 2-teilig

MINI-APL-CLICK-system 4-7 mm, 2 parts

451

**MINI-APL-Klick-
Abschlussprofil**

4 - 7 mm, zum Klicken, Aluminium

MINI-APL-click-end 4 - 7 mm, to click, aluminium

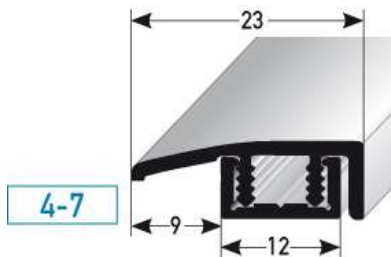

SB-Pack inkl. Schrauben + Dübel; VE 20 Stk.			
self-service-pack with screws + dowels; à 20 pcs.			
Farbe/colour	L / l (m)	Art./ref.	€/Stk./pcs.
silberfarbig silver	0,9	68572-2	15,90
	1,0	68574-6	17,64
	2,7	68576-0	47,64
goldfarbig gold	0,9	68578-4	16,30
	1,0	68580-7	18,14
	2,7	68582-1	48,92
bronzef. hell bronze light	0,9	68584-5	17,72
	1,0	68586-9	19,70
	2,7	68588-3	53,16
bronzef. dunkel bronze dark	0,9	68590-6	17,72
	1,0	68592-0	19,70
	2,7	68594-4	53,16
gold hell gold light	0,9	68596-8	16,30
	1,0	68598-2	18,14
	2,7	68600-2	48,92
edelstahlfarbig/ AL-INOX stainless steel coloured	0,9	68602-6	17,72
	1,0	68604-0	19,70
	2,7	68606-4	53,16

APL-KLICK-System 7-10 mm, 2-teilig

APL-CLICK-system 7-10 mm, 2 parts

276

**APL-Klick-
Abschlussprofil**

**7 - 10 mm, zum Klicken,
Aluminium**

APL-click-end 7 - 10 mm, to click, aluminium

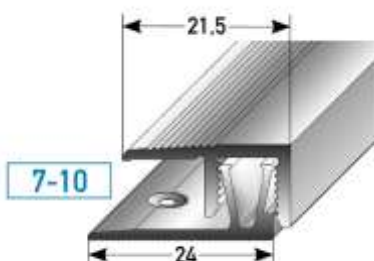

SB-Pack inkl. Schrauben + Dübel; VE 20 Stk.			
self-service-pack with screws + dowels; à 20 pcs.			
Farbe/colour	L / l (m)	Art./ref.	€/Stk./pcs.
silberfarbig silver	0,9	48616-9	15,76
	1,0	48618-3	17,54
	2,7	48620-6	47,26
goldfarbig gold	0,9	48622-0	15,90
	1,0	48624-4	17,62
	2,7	48626-8	47,62
bronzef. hell bronze light	0,9	48628-2	16,82
	1,0	48630-5	18,70
	2,7	48632-9	50,50
bronzef. dunkel bronze dark	0,9	48634-3	16,82
	1,0	48636-7	18,70
	2,7	48638-1	50,50
gold hell gold light	0,9	48640-4	15,90
	1,0	48642-8	17,62
	2,7	48644-2	47,62
edelstahlfarbig/ AL-INOX stainless steel coloured	0,9	48646-6	16,82
	1,0	48648-0	18,70
	2,7	48650-3	50,50
Buche beech	0,9	48652-7	22,06
	1,0	48654-1	24,54
	2,7	48656-5	66,26
Eiche oak	0,9	48658-9	22,06
	1,0	48660-2	24,54
	2,7	48662-6	66,26
Ahorn maple	0,9	48664-0	22,06
	1,0	48666-4	24,54
	2,7	48668-8	66,26
Kirschbaum cherry wood	0,9	48670-1	22,06
	1,0	48672-5	24,54
	2,7	48674-9	66,26
Eiche rustikal rustic oak	0,9	48676-3	22,06
	1,0	48678-7	24,54
	2,7	48680-0	66,26

Holzdekorfolie/ wood decor

Für 7-10 mm-Beläge + 2 mm Dämmung
for 7-10 mm coverings + 2 mm insulation

7. SYSTEMPROFILE FÜR 4-24mm BELÄGE/ 7. PROFILES FOR 4-24mm FLOORINGS

APL-KLICK-System 11-15 mm, 2-teilig

APL-CLICK-system 11-15 mm, 2 parts

277 APL-Klick-Abschlussprofil
11 - 15 mm, zum Klicken,
Aluminium

APL-click-end 11 - 15 mm, to click, aluminium

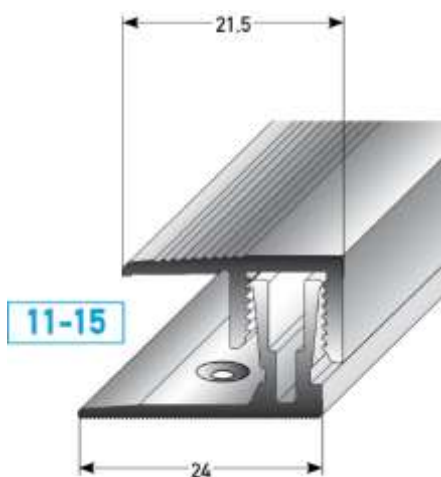

Für 11-15 mm-Beläge + 2 mm Dämmung
 for 11-15 mm coverings + 2 mm insulation

SB-Pack inkl. Schrauben + Dübel; VE 20 Stk.

self-service-pack with screws + dowels; à 20 pcs.

Farbe/colour	L / l (m)	Art./ref.	€/Stk./pcs.
silberfarbig silver	0,9	48694-7	16,86
	1,0	48696-1	18,72
	2,7	48698-5	50,54
goldfarbig gold	0,9	48700-5	16,96
	1,0	48702-9	18,88
	2,7	48704-3	50,90
bronzef. hell bronze light	0,9	48706-7	17,90
	1,0	48708-1	19,90
	2,7	48710-4	53,76
bronzef. dunkel bronze dark	0,9	48712-8	17,90
	1,0	48714-2	19,90
	2,7	48716-6	53,76
gold hell gold light	0,9	48718-0	16,96
	1,0	48720-3	18,88
	2,7	48722-7	50,90
edelstahlfarbig/ AL-INOX stainless steel coloured	0,9	48724-1	17,90
	1,0	48726-5	19,90
	2,7	48728-9	53,76
Buche beech	0,9	48730-2	23,18
	1,0	48732-6	25,78
	2,7	48734-0	69,54
Eiche oak	0,9	48736-4	23,18
	1,0	48738-8	25,78
	2,7	48740-1	69,54
Ahorn maple	0,9	48742-5	23,18
	1,0	48744-9	25,78
	2,7	48746-3	69,54
Kirschbaum cherry wood	0,9	48748-7	23,18
	1,0	48750-0	25,78
	2,7	48752-4	69,54
Eiche rustikal rustic oak	0,9	48754-8	23,18
	1,0	48756-2	25,78
	2,7	48758-6	69,54

Holzdekorfolie/ wood decor

SYSTEMPROFILE FÜR 4-24mm BELÄGE/ PROFILES FOR 4-24mm FLOORINGS

SKD - SYSTEM FÜR KLIICKDESIGN-BELÄGE 4 - 7 mm, flexibel, 2-teilig

SKD - system for click design flooring 4-7 mm, flexible, 2 parts

SB-Pack inkl. Schrauben + Dübel; VE 20 Stk.

self-service-pack with screws + dowels; à 20 pcs.

Farbe/colour	L / l (m)	Art./ref.	€/Stk./pcs.
--------------	-----------	-----------	-------------

315 SKD-Übergangprofil für Klickdesign-Beläge für Höhe 4 - 7 mm, flexibel, Alu., gebohrt

SKD-edge for click design flooring
4 - 7 mm, flexible, aluminium, drilled

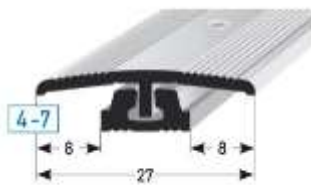

Zusätzliche Schrauben siehe Abschnitt 12.
Additional screws, see section 12.

silberfarbig silver	0,9	49014-2	24,38
	2,7	49016-6	58,84
goldfarbig gold	0,9	49018-0	25,18
	2,7	49020-3	61,60
bronzef. hell bronze light	0,9	49064-7	25,64
	2,7	49066-1	63,38
gold hell gold light	0,9	49022-7	25,18
	2,7	49024-1	61,60
edelstahlfarbig stainless steel coloured	0,9	49026-5	25,64
	2,7	49028-9	63,38

316 SKD-Höhenausgleichprofil f. Klickdesign-Beläge f. Höhe 4 - 7 mm, flexibel, Alu., gebohrt

SKD-height levelling for click design flooring
4 - 7 mm, flexible, aluminium, drilled



Zusätzliche Schrauben siehe Abschnitt 12.
Additional screws, see section 12.

silberfarbig silver	0,9	49030-2	25,64
	2,7	49032-6	63,12
goldfarbig gold	0,9	49034-0	26,64
	2,7	49036-4	66,36
bronzef. hell bronze light	0,9	49068-5	27,18
	2,7	49070-8	68,62
gold hell gold light	0,9	49038-8	26,64
	2,7	49040-1	66,36
edelstahlfarbig stainless steel coloured	0,9	49042-5	27,18
	2,7	49044-9	68,62

317 SKD-Abschlussprofil für Klickdesign-Beläge für Höhe 4 - 7 mm, flexibel, Alu., gebohrt

SKD-end for click design flooring
4 - 7 mm, flexible, aluminium, drilled



Zusätzliche Schrauben siehe Abschnitt 12.
Additional screws, see section 12.

silberfarbig silver	0,9	49046-3	24,00
	2,7	49048-7	57,44
goldfarbig gold	0,9	49050-0	24,64
	2,7	49052-4	59,96
bronzef. hell bronze light	0,9	49072-2	25,18
	2,7	49074-6	61,66
gold hell gold light	0,9	49054-8	24,64
	2,7	49056-2	59,96
edelstahlfarbig stainless steel coloured	0,9	49058-6	25,18
	2,7	49060-9	61,66

327 SKD-Lifter 4 mm für Profilerhöhung auf 8 - 11 mm, PVC, gebohrt

SKD-lifter 4 mm,
for increase to 8 - 11 mm,
PVC, drilled

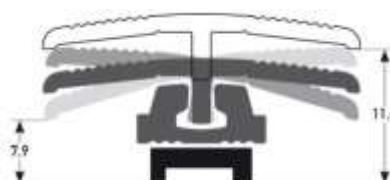

2,7	49062-3	28,04
-----	---------	-------

7. SYSTEMPROFILE FÜR 4-24mm BELÄGE/ 7. PROFILES FOR 4-24mm FLOORINGS

SKD - SYSTEM FÜR KLICKDESIGN-BELÄGE 4 - 7 mm, flexibel, 2-teilig

SKD - system for click design flooring 4-7 mm, flexible, 2 parts

SB-Pack inkl. Schrauben + Dübel; VE 20 Stk.

self-service-pack with screws + dowels; à 20 pcs.

Farbe/colour	L / l (m)	Art./ref.	€/Stk./pcs.
--------------	-----------	-----------	-------------

351 SKD-Treppenkante für Klickdesign-Beläge für Höhe 4 - 7 mm, flexibel, Alu., gebohrt

SKD-stair nosing for click design flooring
 4 - 7 mm, flexible, aluminium, drilled

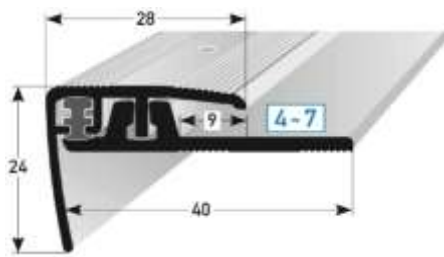

Zusätzliche Schrauben siehe Abschnitt 12.
 Additional screws, see section 12.

silberfarbig silver	0,9	49078-4	39,18
	2,7	49088-3	105,82
goldfarbig gold	0,9	49080-7	40,64
	2,7	49090-6	109,78
bronzef. hell bronze light	0,9	49086-9	41,66
	2,7	49096-8	112,50
gold hell gold light	0,9	49082-1	40,64
	2,7	49092-0	109,78
edelstahlfarbig stainless steel coloured	0,9	49084-5	41,66
	2,7	49094-4	112,50

SKD - System für Klickdesign-Beläge

SKD - system for click design flooring



Beispiel: SLP-System 7 - 17 mm + 12 - 22 mm (siehe Seite 110-112)
 example: SLP-system 7 - 17 mm + 12 - 22 mm (see page 110-112)

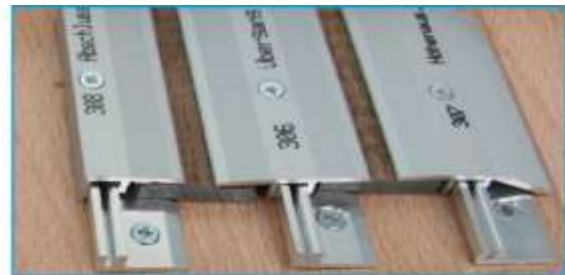

Beispiel: Mini-APL-System 5 - 9 mm (siehe Seite 98 - 101)
 example: Mini-APL-system 5 - 9 mm (see page 98 - 101)



Beispiel: APL-System 7 - 15 mm (siehe Seite 98 - 101)
 example: APL-system 7 - 15 mm (see page 98 - 101)



Beispiel: APL-KLICK-System 4 - 7 / 7 - 10 / 11 - 15 / 15 - 24 mm
 (siehe Seite 102 - 107)
 example: APL-KLICK-system 4 - 7 / 7 - 10 / 11 - 15 / 15 - 24 mm
 (see page 102 - 107)

7. SYSTEMPROFILE FÜR 4-24mm BELÄGE/ 7. PROFILES FOR 4-24mm FLOORINGS

SLP-System 7-17 mm, FLEX, 3-teilig

SLP-system 7-17 mm, flexible, 3 parts

138 SLP-Übergangprofil 35 mm für Laminat/ Parkett 7 - 17 mm flexibel, 3-teilig, Aluminium, gebohrt

SLP-edge 35 mm for laminate/ wooden floors, 7 - 17 mm, flexible 3 parts, aluminium, drilled

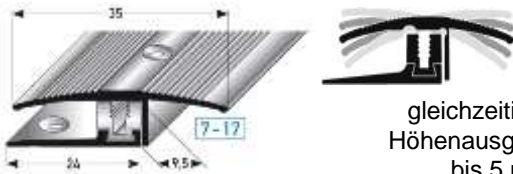

gleichzeitiger
Höhenausgleich
bis 5 mm
height levelling up to 5 mm

Grundprofilerrhöhung siehe Seite 99

basic profile increase see page 99

Zusätzliche Schrauben siehe Abschnitt 12.

Additional screws, see section 12.

SB-Pack inkl. Schrauben + Dübel; VE 20 Stk.				
self-service-pack with screws + dowels; à 20 pcs.				
Farbe/colour	L / l (m)	Art./ref.	€/Stk./pcs.	
silberfarbig silver	0,9	42005-7	20,98	
	2,7	42000-2	62,96	
goldfarbig gold	0,9	42015-6	21,38	
	2,7	42010-1	64,22	
bronzef. hell bronze light	0,9	42025-5	24,58	
	2,7	42020-0	73,72	
gold hell gold light	0,9	62020-4	21,38	
	2,7	62025-9	64,22	
Holzdekorfolie/ wood decor	Buche beech	0,9	42045-3	28,22
		2,7	42040-8	84,74
	Eiche oak	0,9	42055-2	28,22
		2,7	42050-7	84,74
	Ahorn maple	0,9	42065-1	28,22
		2,7	42060-6	84,74
	Kirschbaum cherry wood	0,9	43254-8	28,22
		2,7	43256-2	84,74
	Eiche rustikal rustic oak	0,9	43258-6	28,22
		2,7	43260-9	84,74

139 SLP-Höhenausgleichsprofil 39 mm für Laminat/ Parkett 7 - 17 mm flexibel, 3-teilig, Aluminium, gebohrt

SLP-height levelling 39 mm for laminate/ wooden floors, 7 - 17 mm, flexible, 3 parts, aluminium, drilled

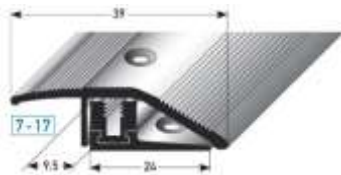

Grundprofilerrhöhung siehe Seite 99

basic profile increase see page 99

Zusätzliche Schrauben siehe Abschnitt 12.

Additional screws, see section 12.

silberfarbig silver	0,9	42075-0	23,40	
	2,7	42070-5	70,04	
goldfarbig gold	0,9	42085-9	23,76	
	2,7	42080-4	71,34	
bronzef. hell bronze light	0,9	42095-8	27,26	
	2,7	42090-3	81,76	
gold hell gold light	0,9	62040-2	23,76	
	2,7	62045-7	71,34	
Holzdekorfolie/ wood decor	Buche beech	0,9	42115-3	29,78
		2,7	42110-8	89,32
	Eiche oak	0,9	42125-2	29,78
		2,7	42120-7	89,32
	Ahorn maple	0,9	42135-1	29,78
		2,7	42130-6	89,32
	Kirschbaum cherry wood	0,9	43264-7	29,78
		2,7	43266-1	89,32
	Eiche rustikal rustic oak	0,9	43268-5	29,78
		2,7	43270-8	89,32

140 SLP-Abschlussprofil 24 mm für Laminat/ Parkett 7 - 17 mm flexibel, 3-teilig, Aluminium, gebohrt

SLP-end 24 mm for laminate/ wooden floors 7 - 17 mm, flexible, 3 parts, aluminium, drilled

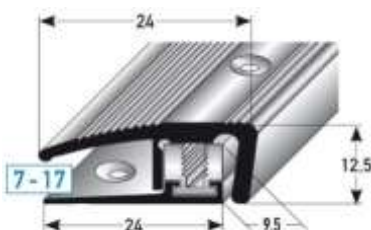

Zusätzliche Schrauben siehe Abschnitt 12.

Additional screws, see section 12.

silberfarbig silver	0,9	42145-0	19,02	
	2,7	42140-5	57,04	
goldfarbig gold	0,9	42155-9	19,44	
	2,7	42150-4	58,36	
bronzef. hell bronze light	0,9	42165-8	22,60	
	2,7	42160-3	67,82	
gold hell gold light	0,9	62060-0	19,44	
	2,7	62065-5	58,36	
Holzdekorfolie/ wood decor	Buche beech	0,9	42185-6	26,90
		2,7	42180-1	80,76
	Eiche oak	0,9	42195-5	26,90
		2,7	42190-0	80,76
	Ahorn maple	0,9	42205-1	26,90
		2,7	42200-6	80,76
	Kirschbaum cherry wood	0,9	43274-6	26,90
		2,7	43276-0	80,76
	Eiche rustikal rustic oak	0,9	43278-4	26,90
		2,7	43280-7	80,76

7. SYSTEMPROFILE FÜR 4-24mm BELÄGE/ 7. PROFILES FOR 4-24mm FLOORINGS

SLP-Treppenkante 7-15,5 mm, FLEX, 3-teilig

SLP-stair nosing 7-15,5 mm, flexible, 3 parts

SB-Pack inkl. Schrauben + Dübel; VE 20 Stk.

self-service-pack with screws + dowels; à 20 pcs.

Farbe/colour	L / l (m)	Art./ref.	€/Stk./pcs.
--------------	-----------	-----------	-------------

141 SLP-Treppenkante 28 mm, für Laminat/ Parkett 7 - 15,5 mm, flexibel, 3-teilig, Alu., gebohrt

SLP-stair nosing 28 mm, for laminate/ wooden floors 7 - 15,5 mm, flexible, 3 parts, aluminium, drilled



Zusätzliche Schrauben siehe Abschnitt 12./
 Additional screws, see section 12.

silberfarbig silver	0,9	41880-1	38,54
	2,7	41890-0	115,64
goldfarbig gold	0,9	41900-6	39,06
	2,7	41910-5	117,14
bronzef. hell bronze light	0,9	41920-4	44,02
	2,7	41930-3	132,08
gold hell gold light	0,9	62000-6	39,06
	2,7	62005-1	117,14

SLP-System für Parkett 12-22 mm, FLEX, 3-teilig

SLP-system for wooden floors 12-22 mm, flexible, 3 parts

164 SLP-Übergangprofil 35 mm, für Parkett 12 - 22 mm, flexibel, 3-teilig, Aluminium, gebohrt

SLP-edge 35 mm for wooden floors 12 - 22 mm, flexible, 3 parts, aluminium, drilled

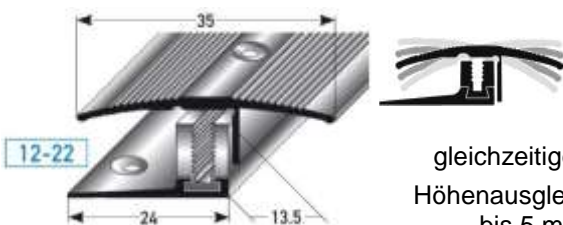

gleichzeitiger Höhenausgleich bis 5 mm
 height levelling up to 5 mm

Holzdekorfolie/ wood decor

silberfarbig silver	0,9	43000-1	27,06
	2,7	43002-5	76,44
goldfarbig gold	0,9	43004-9	27,54
	2,7	43006-3	77,92
bronzef. hell bronze light	0,9	43008-7	31,26
	2,7	43010-0	89,04
gold hell gold light	0,9	43012-4	27,54
	2,7	43014-8	77,92
Buche beech	0,9	43016-2	35,54
	2,7	43018-6	102,04
Eiche oak	0,9	43020-9	35,54
	2,7	43022-3	102,04
Ahorn maple	0,9	43024-7	35,54
	2,7	43026-1	102,04
Kirschbaum cherry wood	0,9	43028-5	35,54
	2,7	43030-8	102,04
Eiche rustikal rustic oak	0,9	43032-2	35,54
	2,7	43034-6	102,04

Grundprofilerhöhung siehe Seite 99

basic profile increase see page 99

Zusätzliche Schrauben siehe Abschnitt 12.

Additional screws, see section 12.

153 SLP-Höhenausgleichsprofil 50 mm, f. Parkett 12 - 22 mm, flexibel, 3-teilig, Alu., gebohrt

SLP-height levelling 50 mm for wooden floors 12 - 22 mm, flexible, 3 parts, aluminium, drilled

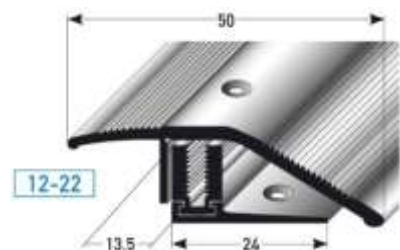

Grundprofilerhöhung siehe Seite 99

basic profile increase see page 99

Zusätzliche Schrauben siehe Abschnitt 12.

Additional screws, see section 12.

Holzdekorfolie/ wood decor

silberfarbig silver	0,9	43046-9	34,24
	2,7	43048-3	102,56
goldfarbig gold	0,9	43050-6	34,82
	2,7	43052-0	104,42
bronzef. hell bronze light	0,9	43054-4	40,06
	2,7	43056-8	120,18
gold hell gold light	0,9	43058-2	34,82
	2,7	43060-5	104,42
Buche beech	0,9	43062-9	43,86
	2,7	43064-3	131,52
Eiche oak	0,9	43066-7	43,86
	2,7	43068-1	131,52
Ahorn maple	0,9	43070-4	43,86
	2,7	43072-8	131,52
Kirschbaum cherry wood	0,9	43074-2	43,86
	2,7	43076-6	131,52
Eiche rustikal rustic oak	0,9	43078-0	43,86
	2,7	43080-3	131,52

7. SYSTEMPROFILE FÜR 4-24mm BELÄGE/ 7. PROFILES FOR 4-24mm FLOORINGS

SLP-System 7-17 mm, Edelstahl matt, FLEX, für Laminat/ Parkett

SLP-system 7-17 mm, stainless steel matt, flexible, for laminate/ wooden floors

SB-Pack inkl. Schrauben + Dübel; VE 20 Stk.

self-service-pack with screws + dowels; à 20 pcs.

Dimension in mm	L / l (m)	Art./ref.	€/Stk./pcs.
-----------------	-----------	-----------	-------------

151 SLP-Übergangprofil 37 mm, Edelstahl matt, für 7 - 17 mm, flexibel, 3-teilig, gebohrt

SLP-edge 37 mm, stainless steel matt, for 7 - 17 mm, flexible, 3 parts, drilled

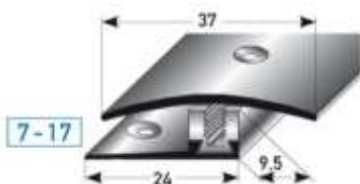

37 x 1,5 mm	0,9	42900-5	31,46
	2,7	42905-0	94,34



gleichzeitig Höhenausgleich bis 5 mm
 height levelling up to 5 mm

Zusätzliche Schrauben siehe Abschnitt 12.
 Additional screws, see section 12.

152 SLP-Höhenausgleichprofil 40 mm, Edelstahl matt, für 7 - 17 mm, flex, 3-teilig, gebohrt

SLP-height levelling 40 mm, stainless steel matt, for 7 - 17 mm, flexible, 3 parts, drilled

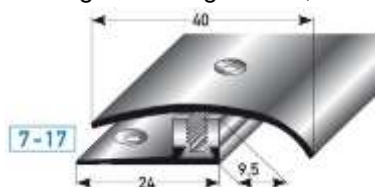

40 x 1,5 mm	0,9	42910-4	33,02
	2,7	42915-9	99,00

Zusätzliche Schrauben siehe Abschnitt 12.
 Additional screws, see section 12.

148 SLP-Abschlussprofil 26 mm, Edelstahl matt, f. Gesamthöhe 7 - 9 mm, flex., 3-teilig, gebohrt

SLP-end 26 mm, stainless steel matt, for heights 7 - 9 mm, flexible, 3 parts, drilled

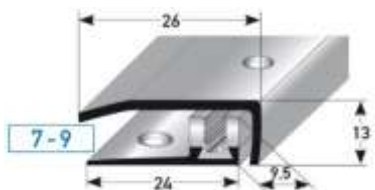

7-9 x 26 x 1,5 mm	0,9	42920-3	31,46
	2,7	42925-8	94,34

Zusätzliche Schrauben siehe Abschnitt 12.
 Additional screws, see section 12.

149 SLP-Abschlussprof. 28 mm, Edelst. matt, f. Gesamthöhe 10 - 13 mm, flex., 3-teilig, gebohrt

SLP-end 28 mm, stainless steel matt, for heights 10 - 13 mm, flexible, 3 parts, drilled

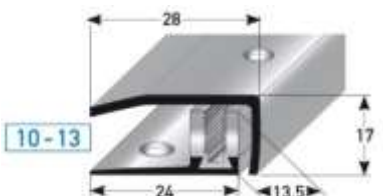

10-13 x 28 x 1,5 mm	0,9	42930-2	33,02
	2,7	42935-7	99,00

Zusätzliche Schrauben siehe Abschnitt 12.
 Additional screws, see section 12.

150 SLP-Abschlussprof. 26 mm, Edelst. matt, f. Gesamthöhe 14 - 17 mm, flex., 3-teilig, gebohrt

SLP-end 26 mm, stainless steel matt, for heights 14 - 17 mm, flexible, 3 parts, drilled

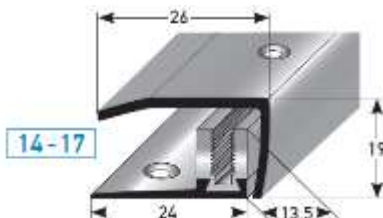

14-17 x 26 x 1,5 mm	0,9	42940-1	33,02
	2,7	42945-6	99,00

Zusätzliche Schrauben siehe Abschnitt 12.
 Additional screws, see section 12.

8. SOCKELLEISTEN AUS EDELSTAHL & ALUMINIUM

8. SKIRTINGS OUT OF STAINLESS STEEL + ALUMINIUM



8. SOCKELLEISTEN/ 8. SKIRTINGS

Andere Abmaße auf Anfrage/ other dimensions on demand

Flach-Sockelleiste aus Edelstahl, matt gebürstet, TYP i-Form							
flat skirting, stainless steel matt brushed, type i-form							
Breite/ width A (mm)	L / l (m)	B = 1,0 mm			B = 1,5 mm		
		Materialstärke/ thickness			Materialstärke/ thickness		
		Koffernr. case no.	Art./ref.	€/Stk./pcs.	Koffernr. case no.	Art./ref.	€/Stk./pcs.

413 Flach-Sockelleiste 1,0 / 1,5 / 2,0 / 3,0 mm, Edelstahl matt

flat skirting
1,0/ 1,5/ 2,0/ 3,0 mm,
stainless steel matt



Bitte Befestigungstyp angeben:

- 01 mittig gebohrt
- 02 seitlich gebohrt
- 03 wechselseitig seitlich
- 04 ungebohrt
- 05 selbstklebend

30 mm	1,00	548	72648-7	9,60	549	72660-9	13,88
	2,50		72650-0	24,00		72662-3	34,66
35 mm	1,00	550	72652-4	11,20	551	72664-7	15,94
	2,50		72654-8	28,00		72666-1	29,10
40 mm	1,00	442	68350-6	12,32	443	68362-9	18,54
	2,50		68352-0	30,82		68364-3	46,26
45 mm	1,00	552	72656-2	14,40	553	72668-5	19,66
	2,50		72658-6	35,98		72670-8	49,16
50 mm	1,00	285	67420-7	16,52	288	67442-9	20,80
	2,50		61892-8	41,58		61906-2	52,00
60 mm	1,00	286	67422-1	20,52	289	67444-3	24,96
	2,50		61894-2	51,32		61908-6	62,40
70 mm	1,00	414	67424-5	22,94	416	67446-7	29,10
	2,50		67426-9	57,24		67448-1	72,80
80 mm	1,00	287	67428-3	25,80	290	67450-4	33,26
	2,50		61896-6	64,54		61910-9	83,16
100 mm	1,00	415	67430-6	32,72	291	67452-8	41,60
	2,50		67432-0	81,86		61912-3	103,96

Please specify fixing:

- 01 drilled centrally
- 02 drilled laterally
- 03 alternating sides drilled
- 04 undrilled
- 05 self adhesive

Anfertigung von passenden Innen- und Außenecken siehe Seite 116 - Lieferzeit nach Vereinbarung
production of matching corners see page 116 - delivery time by prior arrangement

Breite/ width A (mm)	L / l (m)	B = 2,0 mm			B = 3,0 mm		
		Materialstärke/ thickness			Materialstärke/ thickness		
		Koffernr. case no.	Art./ref.	€/Stk./pcs.	Koffernr. case no.	Art./ref.	€/Stk./pcs.
30 mm	1,00	554	72672-2	18,40	555	72684-5	25,98
	2,50		72674-6	45,98		72686-9	64,98
35 mm	1,00	556	72676-0	21,32	557	72688-3	30,32
	2,50		72678-4	53,64		72690-6	75,82
40 mm	1,00	444	68374-2	24,66	445	68386-5	37,00
	2,50		68376-6	61,70		68388-9	92,52
45 mm	1,00	558	72680-7	26,20	559	72692-0	39,00
	2,50		72682-1	65,48		72694-4	97,50
50 mm	1,00	417	67464-1	27,72	422	67496-2	41,60
	2,50		67466-5	69,32		67498-6	103,96
60 mm	1,00	418	67468-9	33,26	423	67500-6	49,90
	2,50		67470-2	83,16		67502-0	124,76
70 mm	1,00	419	67472-6	38,82	424	67504-4	58,22
	2,50		67474-0	97,02		67506-8	145,54
80 mm	1,00	420	67476-4	44,38	425	67508-2	66,54
	2,50		67478-8	110,92		67510-5	166,34
100 mm	1,00	421	67480-1	55,44	426	67512-9	83,16
	2,50		67482-5	138,62		67514-3	207,94

**Bohrungen bis 2 mm Stärke für 3,5 mm Schrauben;
Bohrungen bei 3 mm Stärke für 4 mm Schrauben**

holes up to 2 mm thickness for 3.5 mm screws;
drilling at 3 mm for 4 mm screws

Edelstahlschrauben siehe Abschnitt 12
stainless steel screws see section 12

8. SOCKELLEISTEN/ 8. SKIRTINGS

Abkant-Sockelleiste Edelstahl matt, gekantet, TYP L- & j-Form							
edged skirting out of stainless steel matt, type L- + j-form							
Bitte bei Bestellung immer Winkel, 94° oder 135°, angeben! Please specify when ordering the number of degrees of tilt with 94° or 135°!							
AxBxC mm	L / l (m)	selbstkl./ self-adhesive	€/m	gebohrt/ drilled	€/m	ohne alles/ bare	€/m

Andere Abmaße auf
Anfrage/ other dimensions
on demand

Abkant-Sockelleiste, **Edelstahl** matt, gekantet auf 94° oder 135°

edged skirting, stainless
steel matt, edged 94°
or 135°



473

40 x 10 x 1,0	2,5	69704-6	16,38/m	69718-3	15,04/m	69732-9	13,22/m
40 x 15 x 1,0	2,5	69706-0	17,66/m	69720-6	16,38/m	69734-3	14,52/m
40 x 10 x 1,5	2,5	69708-4	22,98/m	69722-0	21,64/m	69736-7	19,82/m
40 x 15 x 1,5	2,5	69710-7	24,98/m	69724-4	23,64/m	69738-1	21,82/m
40 x 15 x 2,0	2,5	69712-1	32,22/m	69726-8	30,92/m	69740-4	29,06/m
40 x 15 x 3,0	2,5	69714-5	46,74/m	69728-2	45,44/m	69742-8	43,58/m

223

50 x 10 x 1,0	2,5	69748-0	17,54/m	69762-6	16,20/m	60320-7	14,38/m
50 x 15 x 1,0	2,5	69750-3	17,66/m	69764-0	16,38/m	69778-7	14,52/m
50 x 10 x 1,5	2,5	69752-7	26,92/m	69766-4	25,60/m	69780-0	23,76/m
50 x 15 x 1,5	2,5	69754-1	28,94/m	69768-8	27,62/m	69782-4	25,78/m
50 x 15 x 2,0	2,5	69756-5	37,50/m	69770-1	36,20/m	69784-8	34,36/m
50 x 15 x 3,0	2,5	69758-9	54,70/m	69772-5	53,40/m	69786-2	51,56/m

Bitte bei
Bestellung die
genaue Gradzahl
angeben!

Please specify the exact
number of degrees
when ordering!

224

60 x 10 x 1,0	2,5	69792-3	21,64/m	69806-7	20,36/m	69820-3	18,54/m
60 x 15 x 1,0	2,5	69794-7	28,60/m	69808-1	27,30/m	61600-9	25,46/m
60 x 10 x 1,5	2,5	69796-1	30,90/m	69810-4	29,56/m	69824-1	27,74/m
60 x 15 x 1,5	2,5	69798-5	32,86/m	69812-8	31,58/m	69826-5	29,76/m
60 x 15 x 2,0	2,5	69800-5	42,78/m	69814-2	41,52/m	69828-9	39,62/m
60 x 15 x 3,0	2,5	69802-9	62,60/m	69816-6	61,32/m	69830-2	59,46/m

225

80 x 10 x 1,0	2,5	69836-4	26,92/m	69850-0	25,60/m	69864-7	23,76/m
80 x 15 x 1,0	2,5	69838-8	33,90/m	69852-4	32,60/m	61610-8	30,76/m
80 x 10 x 1,5	2,5	69840-1	38,84/m	69854-8	37,54/m	69868-5	35,70/m
80 x 15 x 1,5	2,5	69842-5	40,80/m	69856-2	39,50/m	69870-8	37,64/m
80 x 15 x 2,0	2,5	69844-9	53,38/m	69858-6	52,04/m	69872-2	50,22/m
80 x 15 x 3,0	2,5	69846-3	78,50/m	69860-9	77,16/m	69874-6	75,34/m

226

100 x 10 x 1,0	2,5	69880-7	33,80/m	69894-4	30,92/m	69908-8	29,06/m
100 x 15 x 1,0	2,5	69882-1	35,12/m	69896-8	32,22/m	69910-1	30,40/m
100 x 10 x 1,5	2,5	69884-5	48,34/m	69898-2	45,44/m	69912-5	43,58/m
100 x 15 x 1,5	2,5	69886-9	50,32/m	69900-2	47,44/m	61620-7	45,60/m
100 x 15 x 2,0	2,5	69888-3	65,48/m	69902-6	62,60/m	69916-3	60,78/m
100 x 15 x 3,0	2,5	69890-6	95,92/m	69904-0	93,02/m	69918-7	91,18/m

Anfertigung von passenden Innen- und Außenecken siehe Seite 116 - Lieferzeit nach Vereinbarung

production of matching corners see page 116 - delivery time by prior arrangement

Abkantung mit Dach, um alte Sockelleisten zu überdecken,
auf Anfrage erhältlich

edged with a roof to cover old skirtings, available on request



8. SOCKELLEISTEN/ 8. SKIRTINGS

Andere Abmaße auf
 Anfrage/ other dimensions
 on demand

Einklebe-Sockelleiste Edelstahl matt, gekantet, TYP r-Form							
stainless steel skirting for bonding flooring, edged, matt, type r-form							
AxBxC mm	L / l (m)	selbstkl./ self-adhesive	€/m	gebohrt/ drilled	€/m	ohne alles/ bare	€/m

Einklebe-Sockelleiste **Edelstahl** matt, gekantet

stainless steel
 skirtings for bonding
 flooring, edged, matt



452	40 x 6 x 1,0	2,5	68618-7	15,34/m	68626-2	14,00/m	68634-7	12,18/m
	40 x 11 x 1,0	2,5	68620-0	16,62/m	68628-6	15,34/m	68636-1	13,48/m
453	50 x 6 x 1,0	2,5	68642-2	17,96/m	68650-7	16,62/m	68658-3	14,80/m
	50 x 11 x 1,0	2,5	68644-6	19,26/m	68652-1	17,98/m	68660-6	16,14/m
454	60 x 6 x 1,0	2,5	68666-8	20,56/m	68674-3	19,26/m	68682-8	17,44/m
	60 x 11 x 1,0	2,5	68668-2	21,92/m	68676-7	20,60/m	68684-2	18,76/m
455	80 x 6 x 1,0	2,5	68690-3	25,86/m	68698-9	24,56/m	68706-1	22,72/m
	80 x 11 x 1,0	2,5	68692-7	27,20/m	68700-9	25,86/m	68708-5	24,04/m
456	100 x 6 x 1,5	2,5	68714-6	46,74/m	68722-1	43,86/m	68730-6	42,04/m
	100 x 11 x 1,5	2,5	68716-0	48,72/m	68724-5	45,84/m	68732-0	44,00/m

Anfertigung von passenden Innen- und Außenecken siehe unten
 production of matching corners see below

Passende Ecken (30 x 30 mm), feingeschweißt, für alle Sockelleisten:

auf Gehrung geschnitten, feingeschweißt, als 90°-Ecke
 matching corners (30 x 30 mm) for all skirtings, finely welded, as a 90° corner

	Art./ref.	Preis pro Ecke price per corner
Innenecke inside corner	61830-0	Laufmeterpreis der jeweiligen Sockelleiste = Preis pro Ecke price per meter of the respective skirting = price per corner
Außenecke outside corner	61840-9	

Auf Wunsch an Stange gearbeitet./ Worked on rod on request.
 Andere Gradzahlen auf Anfrage möglich. / Other degrees possible on request.

Lieferzeit nach Vereinbarung

delivery time by prior arrangement

Beispiel: Außenecke
 Aluminium silber
 example: outside corner
 aluminium silver



Beispiel: Innenecke
 Aluminium silber
 example: inside corner
 aluminium silver



8. SOCKELLEISTEN/ 8. SKIRTINGS

Andere Abmaße auf Anfrage/
other dimensions on demand

Lieferzeit für Pulver-
beschichtung auf Anfrage
delivery time for powder coating on
request

Aluminium-Flach-Sockelleiste Typ i-Form							
aluminium flat skirting type i-form							
AxB mm	L / l (m)	selbstkl./ self-adhesive	€/m	gebohrt/ drilled	€/m	ohne alles/ bare	€/m
Selbstklebende Sockelleisten zusätzlich punktweise mit Montagekleber befestigen! Please fasten self adhesive skirtings also with dots of builders adhesive!							

Flach-Sockelleiste, Aluminium, Typ i-Form

flat skirting,
aluminium,
type i-form

457
538
539

silber elox. silver anodized	40 x 1,0	2,5	68736-8	9,22/m	68744-3	7,92/m	68752-8	6,06/m
	40 x 2,0	2,5	68738-2	15,34/m	68746-7	14,00/m	68754-2	12,18/m
	40 x 3,0	2,5*	68740-5	21,42/m	68748-1	20,12/m	68756-6	18,26/m
edelstahl- farbig stainless steel coloured	40 x 1,0	2,5*	68760-3	11,60/m	68768-9	10,28/m	68776-4	8,46/m
	40 x 2,0	2,5*	68762-7	17,66/m	68770-2	16,38/m	68778-8	14,52/m
	40 x 3,0	2,5*	68764-1	23,76/m	68772-6	22,48/m	68780-1	20,66/m
Pulvern n. RAL/ powder RAL (Preis ab 150 lfm./ price from 150 m)	40 x 1,0	2,5	68784-9	17,12/m	68792-4	15,78/m	68800-6	13,96/m
	40 x 2,0	2,5	68786-3	23,18/m	68794-8	21,86/m	68802-0	20,02/m
	40 x 3,0	2,5	68788-7	29,32/m	68796-2	27,98/m	68804-4	26,16/m
Pulvern nach RAL unter 150 lfm. auf Anfrage powdered (RAL) less than 150 m on request								

HÖHE/ height
40 mm



458
540
541

silber elox. silver anodized	50 x 1,0	2,5	68808-2	10,76/m	68816-7	9,44/m	68824-2	7,60/m
	50 x 2,0	2,5	68810-5	18,38/m	68818-1	17,08/m	68826-6	15,22/m
	50 x 3,0	2,5*	68812-9	25,46/m	68820-4	24,14/m	68828-0	22,32/m
edelstahl- farbig stainless steel coloured	50 x 1,0	2,5*	68832-7	12,84/m	68840-2	11,54/m	68848-8	9,70/m
	50 x 2,0	2,5*	68834-1	20,76/m	68842-6	19,42/m	68850-1	17,60/m
	50 x 3,0	2,5*	68836-5	27,78/m	68844-0	26,46/m	68852-5	24,64/m
Pulvern n. RAL/ powder RAL (Preis ab 150 lfm./ price from 150 m)	50 x 1,0	2,5	68856-3	18,62/m	68864-8	17,30/m	68872-3	15,46/m
	50 x 2,0	2,5	68858-7	26,24/m	68866-2	24,96/m	68874-7	23,10/m
	50 x 3,0	2,5	68860-0	33,34/m	68868-6	32,02/m	68876-1	30,18/m
Pulvern nach RAL unter 150 lfm. auf Anfrage powdered (RAL) less than 150 m on request								

HÖHE/ height
50 mm

298
428
299
300

silber elox. silver anodized	60 x 1,0	2,5	61918-5	12,94/m	61924-6	11,38/m	61930-7	9,76/m
	60 x 2,0	2,5	67240-1	18,58/m	67246-3	18,14/m	67252-4	15,40/m
	60 x 3,0	2,5*	61938-3	26,90/m	61944-4	25,38/m	61950-5	23,70/m
	60 x 5,0	3,0*	61958-1	40,46/m	61964-2	38,96/m	61970-3	37,26/m
edelstahl- farbig stainless steel coloured	60 x 1,0	2,5*	61920-8	15,04/m	61926-0	13,52/m	61932-1	11,84/m
	60 x 2,0	2,5*	67242-5	24,90/m	67248-7	23,38/m	67254-8	21,76/m
	60 x 3,0	2,5*	61940-6	29,02/m	61946-8	27,52/m	61952-9	25,84/m
	60 x 5,0	3,0*	61960-4	42,58/m	61966-6	41,06/m	61972-7	39,40/m

HÖHE/ height
60 mm

* inklusive 40 mm
Klemmstelle an
einer Seite vom
Eloxieren/ including
40 mm clamping point
on one side by
anodizing

Pulvern n. RAL/ powder RAL (Preis ab 150 lfm./ price from 150 m)	60 x 1,0	2,5	61922-2	21,82/m	61928-4	20,32/m	61934-5	18,62/m
	60 x 2,0	2,5	67244-9	25,44/m	67250-0	23,94/m	67256-2	22,30/m
	60 x 3,0	2,5	61942-0	35,80/m	61948-2	34,26/m	61954-3	32,60/m
	60 x 5,0	3,0	61962-8	49,34/m	61968-0	47,80/m	61974-1	46,18/m
Pulvern nach RAL unter 150 lfm. auf Anfrage powdered (RAL) less than 150 m on request								

3,0 m-Ware ist nur per Spedition lieferbar (gesonderte Transportkosten)

3,0 m profiles are only available per forwarding agency (separate transport costs)

Anfertigung von passenden Innen- und Außenecken siehe Seite 116 - Lieferzeit nach Vereinbarung
production of matching corners see page 116 - delivery time by prior arrangement

8. SOCKELLEISTEN/ 8. SKIRTINGS

Andere Abmaße auf Anfrage/

other dimensions on demand

Lieferzeit für Pulverbeschichtung auf Anfrage

delivery time for powder coating on request

Aluminium-Flach-Sockelleiste Typ i-Form

aluminium flat skirting type i-form

AxB mm	L / l (m)	selbstkl./ self-adhesive	€/m	gebohrt/ drilled	€/m	ohne alles/ bare	€/m
--------	-----------	-----------------------------	-----	---------------------	-----	---------------------	-----

Selbstklebende Sockelleisten zusätzlich punktweise mit Montagekleber befestigen!
Please fasten self adhesive skirtings also with dots of builders adhesive!

Flach-Sockelleiste, Aluminium, Typ i-Form

flat skirting, aluminium, type i-form

542
543
544

silber elox. silver anodized	80 x 1,0	2,5	68880-8	15,34/m	68888-4	14,00/m	68896-9	12,18/m
	80 x 2,0	2,5	68882-2	27,52/m	68890-7	26,20/m	68898-3	24,38/m
	80 x 3,0	2,5*	68884-6	39,64/m	68892-1	38,38/m	68900-3	36,54/m

HÖHE/ height
80 mm

edelstahl- farbig stainless steel coloured	80 x 1,0	2,5*	68904-1	18,44/m	68912-6	17,16/m	68920-1	15,34/m
	80 x 2,0	2,5*	68906-5	30,64/m	68914-0	29,36/m	68922-5	27,52/m
	80 x 3,0	2,5*	68908-9	42,80/m	68916-4	41,54/m	68924-9	39,64/m

Pulvern n. RAL/ powder RAL (Preis ab 150 lfm./ price from 150 m)	80 x 1,0	2,5	68928-7	24,20/m	68936-2	22,94/m	68944-7	21,06/m
	80 x 2,0	2,5	68930-0	36,40/m	68938-6	35,12/m	68946-1	33,26/m
	80 x 3,0	2,5	68932-4	48,58/m	68940-9	47,26/m	68948-5	45,44/m
Pulvern nach RAL unter 150 lfm. auf Anfrage powdered (RAL) less than 150 m on request								



545
546
547

silber elox. silver anodized	100 x 1,0	2,5	68952-2	19,96/m	68960-7	17,08/m	68968-3	15,22/m
	100 x 2,0	2,5	68954-6	35,18/m	68962-1	32,26/m	68970-6	30,44/m
	100 x 3,0	2,5*	68956-0	50,38/m	68964-5	47,52/m	68972-0	45,66/m

HÖHE/ height
100 mm

edelstahl- farbig stainless steel coloured	100 x 1,0	2,5*	68976-8	23,92/m	68984-3	20,98/m	68992-8	19,16/m
	100 x 2,0	2,5*	68978-2	39,10/m	68986-7	36,22/m	68994-2	34,38/m
	100 x 3,0	2,5*	68980-5	54,34/m	68988-1	51,42/m	68996-6	49,60/m

Pulvern n. RAL/ powder RAL (Preis ab 150 lfm./ price from 150 m)	100 x 1,0	2,5	69000-9	29,40/m	69008-5	26,54/m	69016-0	24,66/m
	100 x 2,0	2,5	69002-3	44,58/m	69010-8	41,72/m	69018-4	39,90/m
	100 x 3,0	2,5	69004-7	59,84/m	69012-2	56,96/m	69020-7	55,14/m
Pulvern nach RAL unter 150 lfm. auf Anfrage powdered (RAL) less than 150 m on request								

Anfertigung von passenden Innen- und Außenecken siehe Seite 116 - Lieferzeit nach Vereinbarung

production of matching corners see page 116 - delivery time by prior arrangement

* inklusive 40 mm Klemmstelle an einer Seite vom Eloxieren/ including 40 mm clamping point on one side by anodizing

Sockelblech

skirting metal sheet

Material/Befestigung material/fixing	A x B (mm)	L / l (m)	Art./ref.	€/Stk. €/pcs.
---	---------------	-----------	-----------	------------------

Sockelblech 200 x 1 mm/ skirting metal sheet 200 x 1 mm

Aluminium blank, gelocht aluminium bare, drilled	200 x 1	1,0 m	22060-2	19,84
---	---------	-------	---------	-------

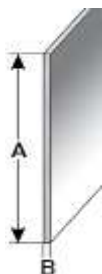

andere Abmaße auf Anfrage/ other dimensions on request

8. SOCKELLEISTEN/ 8. SKIRTINGS

Andere Abmaße auf Anfrage!
other dimensions on demand

Lieferzeit für Pulverbeschichtung auf Anfrage
delivery time for powder coating on request

Abkant-Sockelleiste Aluminium, L- & j-Form							
edged skirting out of aluminium, L- + j-form							
Bitte bei Bestellung immer Winkel, 94° oder 135°, angeben! Please specify when ordering the number of degrees of tilt with 94° or 135°!							
AxBxC mm	L / l (m)	selbstkl./ self-adhesive	€/m	gebohrt/ drilled	€/m	ohne alles/ bare	€/m

Abkant-Sockelleiste, Aluminium, gekantet auf 94° oder 135°

edged skirting, **461**
aluminium,
94° or 135°

Bitte bei Bestellung die genaue Gradzahl angeben! Please specify the exact number of degrees when ordering!

silber elox. silver anodized	40 x 10 x 1,0	2,5	69024-5	13,14/m	69034-4	11,80/m	69044-3	9,98/m
	40 x 20 x 1,0	2,5	69026-9	13,54/m	69036-8	12,22/m	69046-7	10,38/m
	40 x 10 x 2,0	2,5	69028-3	20,36/m	69038-2	19,04/m	69048-1	17,20/m
	40 x 20 x 2,0	2,5	69030-6	21,12/m	69040-5	19,80/m	69050-4	17,98/m
edelstahl- farbig stainless steel coloured	40 x 10 x 1,0	2,5*	69054-2	14,98/m	69064-1	13,66/m	69074-0	11,82/m
	40 x 20 x 1,0	2,5*	69056-6	15,50/m	69066-5	14,20/m	69076-4	12,34/m
	40 x 10 x 2,0	2,5*	69058-0	22,30/m	69068-9	20,96/m	69078-8	19,14/m
	40 x 20 x 2,0	2,5*	69060-3	23,12/m	69070-2	21,82/m	69080-1	19,98/m
Pulvern n. RAL/ powder RAL (Preis ab 150 lfm./ price from 150 m)	40 x 10 x 1,0	2,5	69084-9	21,50/m	69094-8	20,20/m	69104-4	18,34/m
	40 x 20 x 1,0	2,5	69086-3	21,92/m	69096-2	20,60/m	69106-8	18,76/m
	40 x 10 x 2,0	2,5	69088-7	28,74/m	69098-6	27,40/m	69108-2	25,58/m
	40 x 20 x 2,0	2,5	69090-0	29,50/m	69100-6	28,20/m	69110-5	26,34/m
Pulvern nach RAL unter 150 lfm. auf Anfrage powdered (RAL) less than 150 m on request								

HÖHE/ height
40 mm

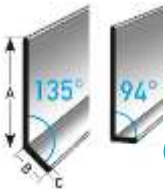

292

293

silber elox. silver anodized	50 x 10 x 1,0	2,5	69662-9	14,00/m	69676-6	12,70/m	69690-2	10,84/m
	50 x 20 x 1,0	2,5	65000-3	14,20/m	65006-5	12,70/m	65012-6	11,02/m
	50 x 10 x 2,0	2,5	69664-3	21,92/m	69678-0	20,60/m	69692-6	18,76/m
	50 x 20 x 2,0	2,5	65020-1	22,24/m	65026-3	20,76/m	65032-4	19,06/m
edelstahl- farbig stainless steel coloured	50 x 10 x 1,0	2,5*	69666-7	16,04/m	69680-3	14,76/m	69694-0	12,90/m
	50 x 20 x 1,0	2,5*	65002-7	16,30/m	65008-9	14,80/m	65014-0	13,14/m
	50 x 10 x 2,0	2,5*	69668-1	24,02/m	69682-7	22,70/m	69696-4	20,86/m
	50 x 20 x 2,0	2,5*	65022-5	24,34/m	65028-7	22,86/m	65034-8	21,20/m

HÖHE/ height
50 mm

Abkantung mit Dach, um alte Sockelleisten zu überdecken, auf Anfrage erhältlich
edged with a roof to cover old skirtings, available on request



296

294

297

295

Pulvern n. RAL/ powder RAL (Preis ab 150 lfm./ price from 150 m)	50 x 10 x 1,0	2,5	69670-4	22,76/m	69684-1	21,44/m	69698-8	19,62/m
	50 x 20 x 1,0	2,5	65004-1	23,06/m	65010-2	21,56/m	65016-4	19,90/m
	50 x 10 x 2,0	2,5	69672-8	30,72/m	69686-5	29,40/m	69700-8	27,56/m
	50 x 20 x 2,0	2,5	65024-9	31,14/m	65030-0	29,60/m	65036-2	27,98/m
Pulvern nach RAL unter 150 lfm. auf Anfrage powdered (RAL) less than 150 m on request								

HÖHE/ height
60 mm

silber elox. silver anodized	60 x 10 x 1,0	2,5	65080-5	14,20/m	65086-7	12,70/m	65092-8	11,02/m
	60 x 20 x 1,0	2,5	65040-9	15,04/m	65046-1	13,52/m	65052-2	11,84/m
	60 x 10 x 2,0	2,5	65100-0	22,24/m	65106-2	20,76/m	65112-3	19,06/m
	60 x 20 x 2,0	2,5	65060-7	24,34/m	65066-9	22,86/m	65072-0	21,20/m
edelstahl- farbig stainless steel coloured	60 x 10 x 1,0	2,5*	65082-9	16,30/m	65088-1	14,80/m	65094-2	13,14/m
	60 x 20 x 1,0	2,5*	65042-3	17,18/m	65048-5	15,60/m	65054-6	13,98/m
	60 x 10 x 2,0	2,5*	65102-4	24,34/m	65108-6	22,86/m	65114-7	21,20/m
	60 x 20 x 2,0	2,5*	65062-1	26,44/m	65068-3	24,98/m	65074-4	23,32/m

* inklusive 40 mm
Klemmstelle an einer
Seite vom Eloxieren/
including 40 mm
clamping point on one
side by anodizing

Pulvern n. RAL/ powder RAL (Preis ab 150 lfm./ price from 150 m)	60 x 10 x 1,0	2,5	65084-3	23,06/m	65090-4	21,56/m	65096-6	19,90/m
	60 x 20 x 1,0	2,5	65044-7	23,96/m	65050-8	22,40/m	65056-0	20,78/m
	60 x 10 x 2,0	2,5	65104-8	31,14/m	65110-9	29,60/m	65116-1	27,98/m
	60 x 20 x 2,0	2,5	65064-5	33,24/m	65070-6	31,70/m	65076-8	30,10/m
Pulvern nach RAL unter 150 lfm. auf Anfrage powdered (RAL) less than 150 m on request								

Anfertigung von passenden Innen- und Außenecken siehe Seite 116 - Lieferzeit nach Vereinbarung
production of matching corners see page 116 - delivery time by prior arrangement

8. SOCKELLEISTEN/ 8. SKIRTINGS

Andere Abmaße auf Anfrage/ other dimensions on demand

Lieferzeit für Pulverbeschichtung auf Anfrage delivery time for powder coating on request

Abkant-Sockelleiste Aluminium, L- & j-Form							
edged skirting out of aluminium, L- + j-form							
Bitte bei Bestellung immer Winkel, 94° oder 135°, angeben! Please specify when ordering the number of degrees of tilt with 94° or 135°!							
AxBxC mm	L / l (m)	selbstkl./ self-adhesive	€/m	gebohrt/ drilled	€/m	ohne alles/ bare	€/m

Abkant-Sockelleiste, Aluminium, gekantet auf 94° oder 135°

edged skirting, aluminium, 94° or 135°

silber elox. silver anodized	80 x 10 x 1,0	2,5	69114-3	17,22/m	69124-2	15,92/m	69134-1	14,06/m
	80 x 20 x 1,0	2,5	69116-7	18,78/m	69126-6	17,52/m	69136-5	15,64/m
	80 x 10 x 2,0	2,5	69118-1	31,32/m	69128-0	30,00/m	69138-9	28,16/m
	80 x 20 x 2,0	2,5	69120-4	34,42/m	69130-3	33,12/m	69140-2	31,26/m

HÖHE/ height
80 mm

462

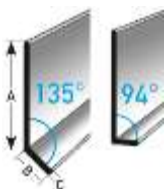

edelstahl- farbig stainless steel coloured	80 x 10 x 1,0	2,5*	69144-0	20,66/m	69154-9	19,34/m	69164-8	17,52/m
	80 x 20 x 1,0	2,5*	69146-4	22,12/m	69156-3	20,80/m	69166-2	18,96/m
	80 x 10 x 2,0	2,5*	69148-8	34,74/m	69158-7	33,40/m	69168-6	31,58/m
	80 x 20 x 2,0	2,5*	69150-1	37,82/m	69160-0	36,54/m	69170-9	34,72/m

Pulvern n. RAL/ powder RAL (Preis ab 150 lfm./ price from 150 m)	80 x 10 x 1,0	2,5	69174-7	26,16/m	69184-6	24,82/m	69194-5	23,00/m
	80 x 20 x 1,0	2,5	69176-1	27,72/m	69186-0	26,40/m	69196-9	24,56/m
	80 x 10 x 2,0	2,5	69178-5	40,22/m	69188-4	38,92/m	69198-3	37,06/m
	80 x 20 x 2,0	2,5	69180-8	43,36/m	69190-7	42,04/m	69200-3	40,20/m
Pulvern nach RAL unter 150 lfm. auf Anfrage powdered (RAL) less than 150 m on request								

HÖHE/ height
100 mm

463

* inklusive 40mm Klemmstelle an einer Seite vom Eloxieren/ including 40 mm clamping point on one side by anodizing

silber elox. silver anodized	100 x 10 x 1,0	2,5	69204-1	20,36/m	69214-0	19,04/m	69224-9	17,20/m
	100 x 20 x 1,0	2,5	69206-5	21,92/m	69216-4	20,60/m	69226-3	18,76/m
	100 x 10 x 2,0	2,5	69208-9	37,56/m	69218-8	36,24/m	69228-7	34,40/m
	100 x 20 x 2,0	2,5	69210-2	40,70/m	69220-1	39,40/m	69230-0	37,56/m

edelstahl- farbig stainless steel coloured	100 x 10 x 1,0	2,5*	69234-8	24,28/m	69244-7	22,98/m	69254-6	21,14/m
	100 x 20 x 1,0	2,5*	69236-2	25,84/m	69246-1	24,54/m	69256-0	22,70/m
	100 x 10 x 2,0	2,5*	69238-6	41,52/m	69248-5	40,18/m	69258-4	38,36/m
	100 x 20 x 2,0	2,5*	69240-9	44,60/m	69250-8	43,34/m	69260-7	41,52/m

Pulvern n. RAL/ powder RAL (Preis ab 150 lfm./ price from 150 m)	100 x 10 x 1,0	2,5	69264-5	29,80/m	69274-4	28,46/m	69284-3	26,64/m
	100 x 20 x 1,0	2,5	69266-9	31,36/m	69276-8	30,04/m	69286-7	28,22/m
	100 x 10 x 2,0	2,5	69268-3	47,00/m	69278-2	45,66/m	69288-1	43,84/m
	100 x 20 x 2,0	2,5	69270-6	50,16/m	69280-5	48,82/m	69290-4	47,00/m
Pulvern nach RAL unter 150 lfm. auf Anfrage powdered (RAL) less than 150 m on request								

Anfertigung von passenden Innen- und Außenecken siehe Seite 116 - Lieferzeit nach Vereinbarung

production of matching corners see page 116 - delivery time by prior arrangement

Abkantung mit Dach, um alte Sockelleisten zu überdecken, auf Anfrage erhältlich

edged with a roof to cover old skirtings, available on request



8. SOCKELLEISTEN/ 8. SKIRTINGS

Lieferzeit für
Pulverbeschichtung
auf Anfrage/ delivery
time for powder coating
on request

Aluminium-Sockelleiste Typ L40/50/60/80/100, stranggepresst							
aluminium skirting type L40/50/60/80/100, extruded							
Selbstklebende Sockelleisten zusätzlich punktweise mit Montagekleber befestigen! Please fasten self-adhesive skirtings also with dots of builders adhesive!							
Farbe/colour	L / l (m)	selbstkl./ self-adhesive	€/m	gebohrt/ drilled	€/m	ohne alles/ bare	€/m

Aluminium-Sockelleiste, TYP L, stranggepresst/ aluminium skirting, type L, extruded

40 x 10 x 1,4 mm

156



silber elox. silver anodized	2,5	44000-0	11,68/m	44004-8	10,28/m	44008-6	8,48/m
edelstahlfarb. Feinschliff fine-honed stainless steel col.	2,5	44036-9	14,00/m	44040-6	13,16/m	44044-4	10,80/m
Pulvern n. RAL; Preis ab 150 lfm. powder RAL; price from 150 m	2,5	44018-5	21,24/m	44022-2	18,98/m	44026-0	15,94/m
Pulvern nach RAL unter 150 lfm. auf Anfrage powdered (RAL) less than 150 m on request							

50 x 10 x 1,4 mm

157



silber elox. silver anodized	2,5	44056-7	12,86/m	44060-4	11,54/m	44064-2	9,80/m
edelstahlfarb. Feinschliff fine-honed stainless steel col.	2,5	44092-5	15,00/m	44096-3	14,12/m	44100-7	11,80/m
Pulvern n. RAL; Preis ab 150 lfm. powder RAL; price from 150 m	2,5	44074-1	23,18/m	44078-9	20,86/m	44082-6	17,84/m
Pulvern nach RAL unter 150 lfm. auf Anfrage powdered (RAL) less than 150 m on request							

60 x 10 x 1,5 mm

158



silber elox. silver anodized	2,5	44112-0	14,12/m	44116-8	12,84/m	44120-5	11,18/m
edelstahlfarb. Feinschliff fine-honed stainless steel col.	2,5	44148-9	16,56/m	44152-6	15,72/m	44156-4	13,36/m
Pulvern n. RAL; Preis ab 150 lfm. powder RAL; price from 150 m	2,5	44130-4	25,38/m	44134-2	23,06/m	44138-0	20,04/m
Pulvern nach RAL unter 150 lfm. auf Anfrage powdered (RAL) less than 150 m on request							

80 x 10 x 1,5 mm

159



silber elox. silver anodized	2,5	44168-7	17,60/m	44172-4	16,18/m	44176-2	14,44/m
edelstahlfarb. Feinschliff fine-honed stainless steel col.	2,5	44204-2	19,54/m	44208-0	17,98/m	44212-7	15,52/m
Pulvern n. RAL; Preis ab 150 lfm. powder RAL; price from 150 m	2,5	44186-1	30,42/m	44190-8	28,16/m	44194-6	25,14/m
Pulvern nach RAL unter 150 lfm. auf Anfrage powdered (RAL) less than 150 m on request							

100 x 10 x 1,7 mm

569



silber elox. silver anodized	2,5	72526-8	19,96/m	72532-9	18,58/m	72538-1	16,90/m
edelstahlfarb. Feinschliff fine-honed stainless steel col.	2,5	72528-2	21,16/m	72534-3	19,78/m	72540-4	18,10/m
Pulvern n. RAL; Preis ab 150 lfm. powder RAL; price from 150 m	2,5	72530-5	30,12/m	72536-7	28,74/m	72542-8	27,06/m
Pulvern nach RAL unter 150 lfm. auf Anfrage powdered (RAL) less than 150 m on request							

8. SOCKELLEISTEN/ 8. SKIRTINGS

Druckguss-Zubehör für Aluminium-Sockelleiste Typen L40 - L100

diecast accessories for aluminium skirting types L40 - L100

Farbe/colour	Art./ref.	€/Stk./ pcs.	Art./ref.	€/Stk./ pcs.	Art./ref.	€/Stk./ pcs.	Art./ref.	€/Stk./ pcs.
--------------	-----------	-----------------	-----------	-----------------	-----------	-----------------	-----------	-----------------

570 Aussenecke für L-Sockelleisten, Druckguss

outside corner for
L-skirtings, diecast



	L40		L60		L80		L100	
silber elox. silver anodized	72372-1	9,96	72392-9	11,94	72412-4	13,96	72432-2	15,94
nach RAL to RAL	72374-5	16,06	72394-3	18,06	72414-8	20,06	72434-6	22,06

571 Innenecke für L-Sockelleisten, Druckguss

inside corner for
L-skirtings, diecast



	L40		L60		L80		L100	
silber elox. silver anodized	72376-9	9,96	72396-7	11,94	72416-2	13,96	72436-0	15,94
nach RAL to RAL	72378-3	16,06	72398-1	18,06	72418-6	20,06	72438-4	22,06

572 Verbinder für L-Sockelleisten, Druckguss

connecting piece for
L-skirtings, diecast



	L40		L60		L80		L100	
silber elox. silver anodized	72380-6	4,96	72400-1	6,10	72420-9	7,26	72440-7	8,42
nach RAL to RAL	72382-0	11,06	72402-5	12,22	72422-3	13,36	72442-1	14,52

573 Endstück LINKS für L-Sockelleisten, Druckguss

left end cap for
L-skirtings, diecast



	L40		L60		L80		L100	
silber elox. silver anodized	72384-4	4,96	72404-9	6,10	72424-7	7,26	72444-5	8,42
nach RAL to RAL	72386-8	11,06	72406-3	12,22	72426-1	13,36	72446-9	14,52

574 Endstück RECHTS für L-Sockelleisten, Druckguss

right end cap for
L-skirtings, diecast



	L40		L60		L80		L100	
silber elox. silver anodized	72388-2	4,96	72408-7	6,10	72428-5	7,26	72448-3	8,42
nach RAL to RAL	72390-5	11,06	72410-0	12,22	72430-8	13,36	72450-6	14,52

8. SOCKELLEISTEN/ 8. SKIRTINGS

Zubehör für Aluminium-Sockelleiste Typen L40 - L100; VE à 10 Stück

accessories for aluminium skirting types L40 - L100; professional packing à 10 pcs.

Farbe/colour	Art./ref.	€/Stk./ pcs.	Art./ref.	€/Stk./ pcs.	Art./ref.	€/Stk./ pcs.	Art./ref.	€/Stk./ pcs.	Art./ref.	€/Stk./ pcs.
--------------	-----------	--------------	-----------	--------------	-----------	--------------	-----------	--------------	-----------	--------------

160 Aussencke für L-Sockelleisten, fein geschweißt

outside corner, finely welded

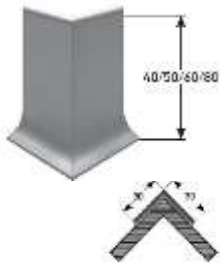

	L40		L50		L60		L80		L100	
silber elox. silver anodized	44232-5	8,48	44294-3	9,80	44356-8	###	44418-3	###	72454-4	17,72
edelstahlfarbig Feinschliff fine-honed stainless steel coloured	44228-8	9,66	44290-5	###	44352-0	###	44414-5	###	72456-8	20,34
nach RAL to RAL	44230-1	###	44292-9	###	44354-4	###	44416-9	###	72458-2	24,16

161 Innenecke für L-Sockelleisten, fein geschweißt

inside corner, finely welded

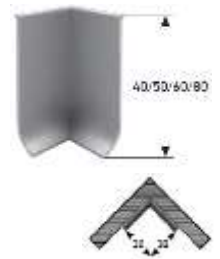

	L40		L50		L60		L80		L100	
silber elox. silver anodized	44238-7	8,48	44300-1	9,80	44362-9	###	44424-4	###	72460-5	17,72
edelstahlfarbig Feinschliff fine-honed stainless steel coloured	44234-9	9,66	44296-7	###	44358-2	###	44420-6	###	72462-9	20,34
nach RAL to RAL	44236-3	###	44298-1	###	44360-5	###	44422-0	###	72464-3	24,16

162 Treppenecke hinten, Sockelleiste + 20 mm Auflagemaß, für L-Sockel., fein geschweißt

stair corner rear, skirting + 20 mm flange, finely welded



	L40		L50		L60		L80		L100	
silber elox. silver anodized	44244-8	8,48	44306-3	9,80	44368-1	###	44430-5	###	72466-7	17,72
edelstahlfarbig Feinschliff fine-honed stainless steel coloured	44240-0	9,66	44302-5	###	44364-3	###	44426-8	###	72468-1	20,34
nach RAL to RAL	44242-4	###	44304-9	###	44366-7	###	44428-2	###	72470-4	24,16

163 Treppenecke vorn, 20 x 20 mm Auflagemaß, für L-Sockelleisten, fein geschweißt

stair corner front, 20 x 20 mm flange, finely welded



	L40		L50		L60		L80		L100	
silber elox. silver anodized	44250-9	8,48	44312-4	9,80	44374-2	###	44436-7	###	72472-8	17,72
edelstahlfarbig Feinschliff fine-honed stainless steel coloured	44246-2	9,66	44308-7	###	44370-4	###	44432-9	###	72474-2	20,34
nach RAL to RAL	44248-6	###	44310-0	###	44372-8	###	44434-3	###	72476-6	24,16

8. SOCKELLEISTEN/ 8. SKIRTINGS

Aluminium-Einklebe-Sockelleiste für 3 mm-Beläge					
aluminium skirting for 3 mm flooring					
Farbe/colour	L / l (m)	gebohrt/ drilled	€/m	ohne alles/ bare	€/m

310 DESIGN-Einklebe-Sockelleiste 60 x 10 x 3,2 mm für Beläge bis 3 mm, Aluminium elox.

DESIGN skirting
 60 x 10 x 3,2 mm for
 bonding floor up to 3 mm,
 aluminium anodized



silber eloxiert silver anodized	2,5	44524-1	14,98/m	73026-2	13,32/m
edelstahlfarbig/ AL-INOX stainless steel coloured	2,5	44532-6	17,50/m	73028-6	15,84/m



Pulverbeschichtet? Selbstklebend? Sonderlängen? Auf Anfrage erhältlich.

Powdered (RAL)? Self-adhesive? Special length cuts? Available on demand.



Beispiel: Design-Sockelleiste, siehe oben
 example: Design skirting, see above

8. SOCKELLEISTEN/ 8. SKIRTINGS

Andere Abmaße und Farben auf Anfrage/
other dimensions and colours on demand

464 Einklebe-Sockelleiste Aluminium silber eloxiert, gekantet
aluminium skirting for bonding flooring, silver anodized, edged



Einklebe-Sockelleiste Aluminium silber eloxiert, gekantet, TYP r-Form							
aluminium skirtings for bonding flooring, edged, type r-form							
AxBxC mm	L / l (m)	selbstkl./ self-adhesive	€/m	gebohrt/ drilled	€/m	ohne alles/ bare	€/m
40 x 4 x 1,0	2,5	69294-2	13,04/m	69302-4	11,76/m	69310-9	9,94/m
40 x 6 x 1,0	2,5	69296-6	13,14/m	69304-8	11,80/m	69312-3	9,98/m
40 x 11 x 1,0	2,5	69298-0	13,24/m	69306-2	11,92/m	69314-7	10,10/m
50 x 4 x 1,0	2,5	69318-5	13,98/m	69326-0	12,66/m	69334-5	10,82/m
50 x 6 x 1,0	2,5	69320-8	14,02/m	69328-4	12,72/m	69336-9	10,86/m
50 x 11 x 1,0	2,5	69322-2	14,14/m	69330-7	12,84/m	69338-3	11,02/m
60 x 4 x 1,0	2,5	69342-0	14,12/m	69350-5	12,82/m	69358-1	11,00/m
60 x 6 x 1,0	2,5	69344-4	14,20/m	69352-9	12,86/m	69360-4	11,04/m
60 x 11 x 1,0	2,5	69346-8	14,34/m	69354-3	13,00/m	69362-8	11,18/m
80 x 4 x 1,0	2,5	69366-6	17,24/m	69374-1	15,94/m	69382-6	14,10/m
80 x 6 x 1,0	2,5	69368-0	17,30/m	69376-5	16,00/m	69384-0	14,14/m
80 x 11 x 1,0	2,5	69370-3	17,44/m	69378-9	16,14/m	69386-4	14,32/m
100 x 4 x 1,5	2,5	69390-1	20,20/m	69398-7	18,88/m	69406-9	17,04/m
100 x 6 x 1,5	2,5	69392-5	20,34/m	69400-7	19,02/m	69408-3	17,18/m
100 x 11 x 1,5	2,5	69394-9	20,52/m	69402-1	19,22/m	69410-6	17,36/m

Lieferzeit für Pulverbeschichtung auf Anfrage/
delivery time for powder coating on request

518



Einklebe-Sockelleiste 45 x h=2,5 mm, Alu., stranggepresst, mit Fliesenstanzung

skirting 45 x h=2,5 mm for bonding flooring, aluminium, extruded, with triangular punching

Farbe/colour	L / l (m)	selbstklebend/ self-adhesive	€/m	gebohrt/ drilled	€/m	ohne alles/ bare	€/m
Alu. pressblank aluminium mill-finish	2,7	-	-	-	-	72250-2	5,50/m

380

Einklebe-Sockelleiste 60 x 3 mm, Aluminium, stranggepresst

skirting 60 x 3 mm for bonding flooring, aluminium, extruded



silber elox. silver anodised	2,5	66494-9	15,06/m	66496-3	13,56/m	66498-7	11,86/m
edelstahlfarbig stainless steel coloured	2,5	66500-7	16,90/m	66502-1	15,38/m	66504-5	13,70/m
Pulvern n. RAL/ powder RAL	2,5	66506-9	21,40/m	66508-3	19,86/m	66510-6	18,20/m
Preis ab 150 lfm./ price from 150 m	Pulvern nach RAL unter 150 lfm. auf Anfrage powdered (RAL) less than 150 m on request						

381

Einklebe-Sockelleiste 60 x 5 mm, Aluminium, stranggepresst

skirting 60 x 5 mm for bonding flooring, aluminium, extruded



silber elox. silver anodised	2,5	66514-4	15,46/m	66516-8	13,96/m	66518-2	12,26/m
edelstahlfarbig stainless steel coloured	2,5	66520-5	17,32/m	66522-9	15,82/m	66524-3	14,12/m
Pulvern n. RAL/ powder RAL	2,5	66526-7	21,80/m	66528-1	20,26/m	66530-4	18,60/m
Preis ab 150 lfm./ price from 150 m	Pulvern nach RAL unter 150 lfm. auf Anfrage powdered (RAL) less than 150 m on request						

382

Einklebe-Sockelleiste 60 x 11 mm, Aluminium, stranggepresst

skirting 60 x 11 mm for bonding flooring, aluminium, extruded

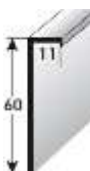

silber elox. silver anodised	2,5	66534-2	16,52/m	66536-6	15,02/m	66538-0	13,34/m
edelstahlfarbig stainless steel coloured	2,5	66540-3	18,60/m	66542-7	17,08/m	66544-1	15,40/m
Pulvern n. RAL/ powder RAL	2,5	66546-5	22,86/m	66548-9	21,34/m	66550-2	19,66/m
Preis ab 150 lfm./ price from 150 m	Pulvern nach RAL unter 150 lfm. auf Anfrage powdered (RAL) less than 150 m on request						

Anfertigung von passenden Innen- und Außenecken siehe Seite 116 - Lieferzeit nach Vereinbarung
production of matching corners see page 116 - delivery time by prior arrangement

8. SOCKELLEISTEN/ 8. SKIRTINGS

CONTEGO-Sockelleiste aus Aluminium, VE = 5 Stück

CONTEGO skirting out of aluminium, unit = 5 pcs.

Farbe/colour	AxB mm	L / l (m)	Art./ref.	€/m
--------------	--------	-----------	-----------	-----

465 CONTEGO-Sockelleiste Aluminum, ohne Befestigungszubehör

CONTEGO skirting
aluminum

ohne Befestigungszubehör
without fixing items

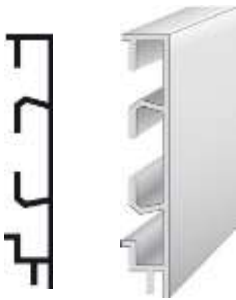

silber elox. silver anodized	40 x 11	2,5	69416-8	16,22 €/m
	60 x 11	2,5	69418-2	20,14 €/m
	60 x 15	2,5	69420-5	23,04 €/m
	100 x 11	2,5	69422-9	27,86 €/m

Pulvern n. RAL/ powder RAL (Preis ab 150 lfm./ price from 150 m)	40 x 11	2,5	69436-6	25,14 €/m
	60 x 11	2,5	69438-0	29,04 €/m
	60 x 15	2,5	69440-3	31,98 €/m
	100 x 11	2,5	69442-7	41,84 €/m
Pulvern nach RAL unter 150 lfm. auf Anfrage powdered (RAL) less than 150 m on request				

auf Anfrage gebohrt erhältlich
drilled on request

Dieses Profil kann mit Montagekleber geklebt, mit Befestigungsclips (siehe Profil-
nr. 466) geclipst, oder auf Anfrage auch gebohrt werden zur Befestigung mit
Schrauben und Dübel./ This profile can be glued with builders adhesive, clipped with fixing clips
(see profile no. 466), or be drilled on request for fixing with screws and dowels.

Lieferzeit für Pulverbeschichtung auf Anfrage / delivery time for powder coating on request

Zubehör für CONTEGO-Sockelleiste

accessories for CONTEGO skirting

466 Befestigungsclip inkl. Schrauben & Dübel für Contego-Sockelleiste

fixing clip with screws and dowels
for CONTEGO skirting

Für eine Contego-Sockelleiste à 2,5 m
empfehlen wir 6 Befestigungsclips.
For Contego skirting à 2,5 m we
recommend 6 fixing clips.



Abpackung/ unit	Art./ref.	€
à 1 Stk./pcs.	69446-5	2,86
Kart./box à 100 Stk./pcs.	69447-2	250,28

467 Abdichtlippe für Contego-Sockelleiste, Silikon metallicfarben

rubber lip for CONTEGO skirting,
silicone metallic coloured



L / l (m)	Art./ref.	€
Rolle/ roll à 20 m	69450-2	98,58 €/Ro.

Für Zuschnitte erheben wir einen Arbeitsaufschlag von 15 %./
For cuttings we charge a labor surcharge of 15%.

8. SOCKELLEISTEN/ 8. SKIRTINGS

Lieferzeit auf Anfrage
 delivery time on request

Zubehör für CONTEGO-Sockelleiste

accessories for CONTEGO skirting

Farbe/colour	VE/unit	für Größe/ for size AxB mm	Art./ref.	€/Stk./pcs.
--------------	---------	-------------------------------	-----------	-------------

468 Innenecke für CONTEGO-Sockelleiste, Aluminumguss

inside corner for CONTEGO skirting, aluminum casting



silberfarbig silver coloured	10 Stk./pcs.	40 x 11	69456-4	24,06
		60 x 11	69458-8	24,06
		60 x 15	69460-1	25,38
		100 x 11	69462-5	28,26

nach RAL to RAL	10 Stk./pcs.	40 x 11	69476-2	28,26
		60 x 11	69478-6	28,26
		60 x 15	69480-9	29,56
		100 x 11	69482-3	32,46

Nur im Zusammenhang mit pulverbeschichteten Sockelleisten möglich!
 Only possible when ordering powder coated skirtings!

469 Außenecke für CONTEGO-Sockelleiste, Aluminumguss

outside corner for CONTEGO skirting, aluminum casting



silberfarbig silver coloured	10 Stk./pcs.	40 x 11	69488-5	24,06
		60 x 11	69490-8	24,06
		60 x 15	69492-2	25,38
		100 x 11	69494-6	28,84

nach RAL to RAL	10 Stk./pcs.	40 x 11	69508-0	28,26
		60 x 11	69510-3	28,26
		60 x 15	69512-7	29,56
		100 x 11	69514-1	33,04

Nur im Zusammenhang mit pulverbeschichteten Sockelleisten möglich!
 Only possible when ordering powder coated skirtings!

470 Verbinder für CONTEGO-Sockelleiste, Aluminumguss

connecting piece for CONTEGO skirting, aluminum casting



silberfarbig silver coloured	10 Stk./pcs.	40 x 11	69520-2	27,22
		60 x 11	69522-6	27,66
		60 x 15	69524-0	28,98
		100 x 11	69526-4	31,40

nach RAL to RAL	10 Stk./pcs.	40 x 11	69540-0	31,40
		60 x 11	69542-4	31,86
		60 x 15	69544-8	33,16
		100 x 11	69546-2	35,62

Nur im Zusammenhang mit pulverbeschichteten Sockelleisten möglich!
 Only possible when ordering powder coated skirtings!

8. SOCKELLEISTEN/ 8. SKIRTINGS

Lieferzeit auf Anfrage
 delivery time on request

Zubehör für CONTEGO-Sockelleiste				
accessories for CONTEGO skirting				
Farbe/colour	VE/unit	für Größe/ for size AxB mm	Art./ref.	€/Stk./pcs.

471 Endstück LINKS für CONTEGO-Sockelleiste, Aluminumguss

left end cap for CONTEGO skirting, aluminum casting



silberfarbig silver coloured	10 Stk./pcs.	40 x 11	69552-3	24,64
		60 x 11	69554-7	25,24
		60 x 15	69556-1	26,58
		100 x 11	69558-5	26,22
nach RAL to RAL	10 Stk./pcs.	40 x 11	69572-1	28,84
		60 x 11	69574-5	29,44
		60 x 15	69576-9	30,76
		100 x 11	69578-3	30,42
Nur im Zusammenhang mit pulverbeschichteten Sockelleisten möglich! Only possible when ordering powder coated skirtings!				

472 Endstück RECHTS für CONTEGO-Sockelleiste, Aluminumguss

right end cap for CONTEGO skirting, aluminum casting



silberfarbig silver coloured	10 Stk./pcs.	40 x 11	69924-8	24,64
		60 x 11	69926-2	25,24
		60 x 15	69928-6	26,58
		100 x 11	69930-9	26,22
nach RAL to RAL	10 Stk./pcs.	40 x 11	69944-6	28,84
		60 x 11	69946-0	29,44
		60 x 15	69948-4	30,76
		100 x 11	69950-7	30,42
Nur im Zusammenhang mit pulverbeschichteten Sockelleisten möglich! Only possible when ordering powder coated skirtings!				

Beispiel: Contego-Sockelleiste mit Zubehör (siehe Seite 126-128)
 example: Contego skirting with accessories (see page 126-128)



Beispiel: Aluminium-Einklebe-Sockelleiste für 3 mm Designbeläge (siehe Seite 124)
 example: Design skirting for bonding floor to 3 mm, aluminium (see page 124)



8. SOCKELLEISTEN/ 8. SKIRTINGS

Klick-Sockelleiste aus Aluminium

aluminium click skirtings

Farbe/colour	L / l (m)	Art./ref.	€/m
--------------	-----------	-----------	-----

301 Klick-Sockelleiste 60 x 15 mm, Aluminum elox., inklusive 6 Wandhalterungen mit

Schrauben & Dübel zur Befestigung

click skirting 60 x 15 mm, aluminum anodized, incl. 6 wall holders with screws and dowels for fastening



silber elox. silver anodized	2,5	61978-9	25,92/m
---------------------------------	-----	---------	---------

edelstahlfarbig/ stainless steel coloured	2,5	61980-2	28,32/m
--	-----	---------	---------

andere Farben auf Anfrage/ other colours on demand

Zubehör für Klick-Sockelleiste 60 x 15 mm

accessories for click skirtings 60 x 15 mm

Material+Farbe/ material+colour	Art./ref.	€
------------------------------------	-----------	---

302 Außenecke für Klicksockelleiste 60 x 15 mm

outside corner for click skirting



Kunststoff silberfarbig plastic silver coloured	61984-0	6,36 €/St./pcs.
--	---------	-----------------

Kunststoff edelstahlfarbig plastic stainless steel coloured	61992-5	6,98 €/St./pcs.
--	---------	-----------------

303 Innenecke für Klicksockelleiste 60 x 15 mm

inside corner for click skirting



Kunststoff silberfarbig plastic silver coloured	61986-4	6,36 €/St./pcs.
--	---------	-----------------

Kunststoff edelstahlfarbig plastic stainless steel coloured	61994-9	6,98 €/St./pcs.
--	---------	-----------------

304 Verbinder für Klicksockelleiste 60 x 15 mm

connecting piece for click skirting

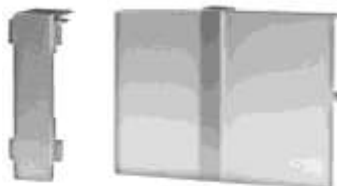

Kunststoff silberfarbig plastic silver coloured	61988-8	5,50 €/St./pcs.
--	---------	-----------------

Kunststoff edelstahlfarbig plastic stainless steel coloured	61996-3	6,06 €/St./pcs.
--	---------	-----------------

305 Endstücke, 1 Paar, für Klicksockelleiste 60 x 15 mm

end caps, 1 pair, for click skirting

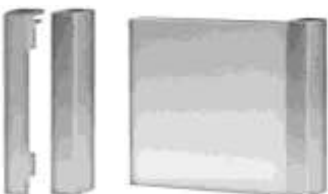

Kunststoff silberfarbig plastic silver coloured	61990-1	10,16 €/Paar/pair
--	---------	-------------------

Kunststoff edelstahlfarbig plastic stainless steel coloured	61998-7	11,20 €/Paar/pair
--	---------	-------------------

9. FLIESENTRENN-, DEHNUNGSFUGEN-, BAU- & T-PROFILE AUS ALUMINIUM, EDELSTAHL, MESSING & PVC

9. CERAMIC TILE SEPARATION, EXPANSION GAP,
 BUILDING + T-PROFILES OUT OF ALUMINIUM,
 STAINLESS STEEL, BRASS + PVC

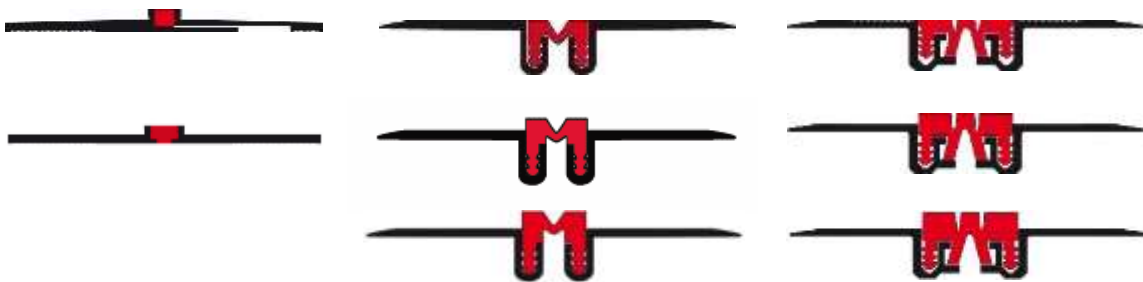

9. FLIESENTRENN-, DEHNUNGSFUGEN-, BAU- & T-PROFILE/ 9. CERAMIC TILE SEPARATION, EXPANSION GAP, BUILDING + T-PROFILES

Fliesentrennprofil

ceramic tile separation profile

Material/material	L / l (m)	Stk./VE / pcs/unit	Innenhöhe/ inside height (mm)	Art./ref.	€/m	€/Stück/pcs.
Aluminium pressblank aluminium mill-finish	2,7 m	10	2,5	72250-2	5,50/m	14,88
			3	71804-8	10,36/m	27,96

Fliesentrennprofil mit breitem Auflageschenkel

518

ceramic tile separation profile with a wide contact surface



$h = \text{Innenhöhe} / \text{Außenmaß} = h + 1 \text{ mm}$
 $h = \text{inside height} / \text{external dimension} = h + 1 \text{ mm}$

Dehnungsfugenprofile auf Anfrage produzierbar!

Expansion gap profiles can be produced on request!

Fliesentrennprofil

ceramic tile separation profile

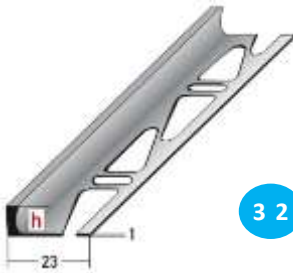

3 2

$h = \text{Innenmaß}$
 $\text{Außenmaß} = h + 1 \text{ mm}$
 $h = \text{inside dimension}$
 $\text{external dimension} = h + 1 \text{ mm}$

Aluminium pressblank aluminium mill-finish	1,0 m	10	2	71808-6	3,84/m	3,84
			2,5	71810-9	3,84/m	3,84
			3	71812-3	3,84/m	3,84
			4,5	71814-7	3,84/m	3,84
			6	71816-1	3,88/m	3,88
Aluminium pressblank aluminium mill-finish	2,5 m	10	2	30129-5	3,84/m	9,62
			2,5	30135-6	3,84/m	9,62
			3	30130-1	3,84/m	9,62
			4,5	30140-0	3,84/m	9,62
			6	30150-9	3,88/m	9,70
			8	30160-8	4,32/m	10,80
			10	30170-7	4,80/m	11,98
			11	30175-2	5,12/m	12,78
			12,5	30180-6	5,32/m	13,32
			15	30190-5	6,00/m	15,00
			18	30766-2	7,68/m	19,22
			20	30767-9	9,62/m	24,04
			22	30195-0	9,76/m	24,38
			25	30768-6	10,32/m	25,82
			30	30769-3	10,90/m	27,24
Aluminium silber eloxiert aluminium silver anodized	2,5 m	10	2	69582-0	5,92/m	14,78
			2,5	69584-4	5,92/m	14,78
			3	69586-8	5,92/m	14,78
			4,5	69588-2	5,92/m	14,78
			6	69590-5	5,96/m	14,92
Aluminium schwarz elox. aluminium black anodized	2,5 m	10	2	69594-3	6,56/m	16,40
			2,5	69596-7	6,56/m	16,40
			3	69598-1	6,56/m	16,40
			4,5	69600-1	6,56/m	16,40
			6	69602-5	6,70/m	16,74
			8	72480-3	6,88/m	17,18
			10	72482-7	6,98/m	17,44
			11,0	72484-1	7,32/m	18,28
			12,5	72486-5	7,46/m	18,66
15	72488-9	8,80/m	22,00			

Andere Größen oder Eloxalfarben auf Anfrage möglich

other sizes or anodized colours available on request

3 2



3 2

9. FLIESENTRENN-, DEHNUNGSFUGEN-, BAU- & T-PROFILE/ 9. CERAMIC TILE SEPARATION, EXPANSION GAP, BUILDING + T-PROFILES

Fliesentrennprofil

ceramic tile separation profile

Fliesentrennprofil

ceramic tile separation profile

3 4



h = Innenmaß
Außenmaß = h + 1 mm
 h = inside dimension
 external dimension = h + 1 mm

3 3

* Bestand muss geprüft werden/ alternativ Aluminium goldfarbig eloxiert anfragen/
 stock has to be checked / alternatively ask for gold coloured anodized aluminium

Innenmaß/ inside measure

Material/material	L / l (m)	Stk./VE / pcs/unit	Höhe/ height (mm)	Art./ref.	€/m	€/Stück/pcs.
Messing pressblank brass mill-finish	2,5 m	10	3	30010-6	18,80/m	47,02
			4,5 *	30020-5	20,10/m	50,26
			6	30030-4	21,08/m	52,72
			8	30040-3	22,62/m	56,56
			10	30050-2	24,92/m	62,32
			12,5	30060-1	26,78/m	66,94
			15	30070-0	27,96/m	69,90
			22	30075-5	34,54/m	86,36

	1,0 m	10	2	71820-8	10,44/m	10,44
			2,5	71822-2	10,44/m	10,44
			3	71824-6	10,44/m	10,44
			4,5	71826-0	10,74/m	10,74
			6	71828-4	11,40/m	11,40

Edelstahl stainless steel	2,5 m	10	2	30072-4	10,42/m	26,06
			2,5	30765-5	10,42/m	26,06
			3	30073-1	10,42/m	26,06
			4,5	30074-8	10,72/m	26,82
			6	30080-9	11,42/m	28,56
			8	30090-8	11,76/m	29,42
			10	30100-4	12,20/m	30,52
			11	30105-9	12,80/m	32,00
			12,5	30110-3	13,06/m	32,66
			15	30120-2	13,48/m	33,70
			17	30123-3	13,90/m	34,76
			20	30762-4	14,32/m	35,78
			22	30125-7	14,56/m	36,42
25	30763-1	15,96/m	39,90			
30	30764-8	17,90/m	44,74			

3 6

PVC weiß ** PVC white	2,5 m	10	6	30340-4 **	3,92/m	9,78
			8	30350-3 **	4,34/m	10,84
			10	30360-2 **	4,70/m	11,76
PVC beige ** PVC beige	2,5 m	10	6	30370-1 **	3,92/m	9,78
			8	30380-0 **	4,34/m	10,84
			10	30390-9 **	4,70/m	11,76
PVC grau ** PVC grey	2,5 m	10	6	30400-5 **	3,92/m	9,78
			8	30410-4 **	4,34/m	10,84
			10	30420-3 **	4,70/m	11,76

** Auslaufartikel / discontinued item

9. FLIESENTRENN-, DEHNUNGSFUGEN-, BAU- & T-PROFILE/ 9. CERAMIC TILE SEPARATION, EXPANSION GAP, BUILDING + T-PROFILES

Flexibles Fliesentrennprofil

flexible ceramic tile separation profile

Flexibles Fliesentrennprofil

flexible ceramic tile separation profile



h = Innenmaß

Außenmaß = h + 1 mm

h = inside dimension
 external dimension = h + 1 mm

* **Bestand muss geprüft werden/ alternativ Aluminium goldfarbig eloxiert anfragen/**
 stock has to be checked / alternatively ask for gold coloured anodized aluminium

Innenmaß/ inside measure						
Material/material	L / l (m)	Stk./VE / pcs/unit	Höhe/ height (mm)	Art./ref.	€/m	€/Stück/ pcs.
Aluminium pressblank aluminium mill-finish	2,5 m	10	2	30268-1	7,12/m	17,78
			3	30270-4	6,38/m	15,94
			4,5	30280-3	6,46/m	16,16
			6	30290-2	6,58/m	16,46
			8	30300-8	6,78/m	16,96
			10	30310-7	7,12/m	17,80
			12,5	30320-6	7,54/m	18,86
			15	30330-5	8,06/m	20,16
			18	69606-3	9,92/m	24,78
			20	69608-7	10,38/m	25,96
			22	30335-0	10,68/m	26,70
			25	69612-4	12,32/m	30,82
30	69614-8	13,50/m	33,76			
Messing pressblank brass mill-finish	2,5 m	10	3	30200-1	20,86/m	52,14
			4,5 *	30210-0	22,00/m	55,02
			6	30220-9	23,42/m	58,56
			8	30230-8	25,56/m	63,92
			10	30240-7	27,44/m	68,60
			12,5	30250-6	28,98/m	72,44
			15	30260-5	31,22/m	78,06
			22	30265-0	35,62/m	89,04
Edelstahl stainless steel	2,5 m	10	3	38000-9	19,36/m	48,40
			4,5	38010-8	19,52/m	48,78
			6	38020-7	21,78/m	54,46
			8	38030-6	22,48/m	56,20
			10	38040-5	23,38/m	58,44
			12,5	38050-4	24,10/m	60,26
15	38060-3	28,96/m	72,38			

35

165

166

Bieegerät für flexible Fliesentrennprofile

bending machine for flexible ceramic tile and separation profiles



Art./ref.	€/Stück/pcs.
31050-1	952,50

MIET-Bieegerät für flexible Fliesentrennprofile für 14-tägige Nutzung

rental bending machine for flexible ceramic tile separation profiles for 14 days of use



Art./ref.	€/Stück/pcs.
71832-1	130,62

Verfügbarkeit auf Anfrage / availability on request

Mietzeit beginnt am Paketzustellungstag / rental period begins on the day of delivery of the package

Rückversand durch Kunde / return shipment by customer

Dehnungsfugenprofile, VE 10 Stück

expansion gap profiles, sales unit 10 pcs.

Dehnungsfugenprofil expansion gap profile



31

**Aluminium
pressblank**
aluminium
mill-finish

h = Innenmaß
Außenmaß = h + 1 mm
h = inside dimension
external dimension = h + 1 mm

**Dehnungsfugenprofile
aus Profilnr. 518 mit
breitem Auflageschenkel
auf Anfrage produzierbar!**

Expansion gap profiles from
profile no. 518 with a wide
support leg can be produced
on request!

Material/ Farbe material/ colour	Silikonfarbe / silicone colour	Länge / length (m)	Innenhöhe/ inside height (mm)	Art./ref.	€/m	€/Stück/ pcs.		
Aluminium pressblank aluminium mill-finish	Silikon grau	1,0 m	2	71836-9	19,28/m	19,28		
			2,5	71838-3	19,32/m	19,32		
			3	71840-6	19,38/m	19,38		
			4,5	71842-0	19,86/m	19,86		
			6	71844-4	19,98/m	19,98		
		2,5 m	2	37630-9	19,28/m	48,20		
			2,5	37105-2	19,32/m	48,32		
			3	37100-7	19,40/m	48,48		
			4,5	37600-2	19,84/m	49,58		
			6	36230-2	19,98/m	49,94		
			8	36240-1	21,34/m	53,36		
			10	36250-0	28,58/m	71,46		
			11	36255-5	32,98/m	82,46		
			12,5	37632-3	37,52/m	93,82		
		3,0 m*	15	37634-7	40,12/m	100,28		
			25	37636-1	52,40/m	130,98		
			2	72492-6	19,28/m	57,84		
			2,5	72494-0	19,32/m	57,94		
			3	72496-4	19,38/m	58,16		
		3,0 m*	4,5	72498-8	19,86/m	59,58		
			6	72500-8	19,96/m	59,90		
			* 3,0 m-Ware ist nur per Spedition lieferbar (gesonderte Transportkosten) / 3,0 m profiles are only available per forwarding agency (separate transport costs)					
			Silikon schwarz	2,5 m	2	72504-6	23,80/m	59,50
					2,5	72506-0	23,84/m	59,60
		3			72508-4	23,94/m	59,84	
		4,5			72510-7	24,48/m	61,18	
		6			72512-1	24,66/m	61,64	
Aluminium silber eloxiert aluminium silver anodized	Silikon grau	2,5 m	2	69620-9	22,58/m	56,46		
			2,5	69622-3	22,64/m	56,58		
			3	69624-7	22,72/m	56,80		
			4,5	69626-1	23,16/m	57,90		
			6	69628-5	23,38/m	58,44		
Aluminium schwarz eloxiert aluminium black anodized	Silikon schwarz	2,5 m	2	69634-6	29,18/m	72,96		
			2,5	69636-0	29,24/m	73,12		
			3	69638-4	29,34/m	73,36		
			4,5	69640-7	29,90/m	74,74		
			6	69642-1	30,32/m	75,78		
	Silikon silber Diamant- Glitter	2,5 m	2	69648-3	39,40/m	98,52		
			2,5	69650-6	39,46/m	98,66		
			3	69652-0	39,62/m	99,04		
			4,5	69654-4	40,36/m	100,92		
			6	69656-8	40,92/m	102,32		

Farbige Silikonereinlagen nach Farbauswahl von Otto Chemie, sowie RAL und NCS:

choice of colours by Otto Chemie, RAL colours and NCS:

- ≤ 12,5 m je Farbe/ ≤ 12,5 m of a colour --> **+48,50 €** Preiszuschlag pauschal/ +48,50 € flat rate surcharge
- ≤ 25 m je Farbe/ ≤ 25m of a colour --> **+30 %** Preiszuschlag/ +30 % surcharge
- > 25 m je Farbe/ > 25m of a colour --> **+20 %** Preiszuschlag/ +20 % surcharge
- ≥ 100 m je Farbe/ ≥ 100m of a colour --> **kein** Preiszuschlag/ no surcharge

Lieferzeit auf Anfrage/ delivery time on request

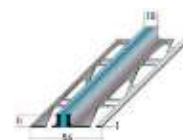

9. FLIESENTRENN-, DEHNUNGSFUGEN-, BAU- & T-PROFILE/ 9. CERAMIC TILE SEPARATION, EXPANSION GAP, BUILDING + T-PROFILES

Dehnungsfugenprofile, VE 10 Stück

expansion gap profiles, sales unit 10 pcs.

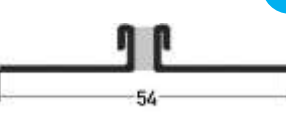
Material/ Farbe material/ colour	Silikonfarbe / silicone colour	Länge / length (m)	Innenhöhe/ inside height (mm)	Art./ref.	€/m	€/Stück/ pcs.
 <p>167 Messing pressblank brass mill-finish</p>	Silikon grau	2,5 m	3	37110-6	58,84/m	147,08
			4,5 *	37610-1	61,84/m	154,62
			6	36290-6	64,70/m	161,74
			8	36300-2	70,04/m	175,12
			10	36310-1	76,50/m	191,24
			12,5	37642-2	88,68/m	221,70
			15	37644-6	94,46/m	236,14
		25	37646-0	115,92/m	289,78	
 <p>168 Edelstahl stainless steel</p>	Silikon grau	1,0 m	2	71848-2	31,44/m	31,44
			2,5	71850-5	31,44/m	31,44
			3	71852-9	31,44/m	31,44
			4,5	71854-3	36,56/m	36,56
			6	71856-7	38,92/m	38,92
		2,5 m	2	37650-7	31,42/m	78,56
			2,5	37651-4	31,42/m	78,56
			3	37115-1	31,42/m	78,56
			4,5	37620-0	36,56/m	91,40
			6	36350-7	38,92/m	97,32
			8	36360-6	44,82/m	112,04
			10	36370-5	60,70/m	151,74
			11	36375-0	65,60/m	164,00
			12,5	37652-1	70,52/m	176,30
15	37654-5	80,92/m	202,30			
25	37656-9	99,74/m	249,36			

* Bestand muss geprüft werden/ alternativ Aluminium goldfarbig eloxiert anfragen/ stock has to be checked / alternatively ask for gold coloured anodized aluminium

h = Innenmaß
Außenmaß = h + 1 mm
h = inside dimension
external dimension = h + 1 mm

Farbige Silikoneinlagen nach Farbauswahl von Otto Chemie, sowie RAL und NCS:

choice of colours by Otto Chemie, RAL colours and NCS:

- ≥ 12,5 m je Farbe/ ≤ 12,5 m of a colour --> **+48,50 €** Preiszuschlag pauschal/ +48,50 € flat rate surcharge
- ≥ 25 m je Farbe/ ≤ 25m of a colour --> **+30 %** Preiszuschlag/ +30 % surcharge
- > 25 m je Farbe/ > 25m of a colour --> **+20 %** Preiszuschlag/ +20 % surcharge
- ≥ 100 m je Farbe/ ≥ 100m of a colour --> **kein** Preiszuschlag/ no surcharge

Lieferzeit auf Anfrage/ delivery time on request

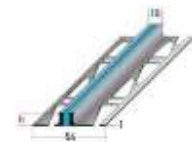

169 PVC-Dehnungsfugenprofil

PVC-expansion gap profile



Farbe / colour	Länge / length (m)	Innenhöhe/ inside height (mm)	Art./ref.	€/m	€/Stück/ pcs.
PVC weiß ** PVC white	2,5 m	6	36440-5 **	10,84/m	27,12
PVC beige ** PVC beige			36500-6 **	10,84/m	27,12
PVC grau ** PVC grey			36560-0 **	10,84/m	27,12

** **Auslaufartikel** / discontinued item

281 Wellenverbinder 70 x 6 mm zur Beseitigung von Estrichrissen

wave connector 70 x 6 mm for fixing concrete floor cracks



Stk./Verpack. pcs./pack	Stk./VE / pcs./unit	Art./ref.	€
Karton à 1000 Stk. box a 1000 pcs.	1	36620-1	82,50/Kart./box
Beutel à 100 St. bag a 100 pcs.	10	36621-8	11,06/Btl./bag

**Ihre Wunschzusammenstellung war noch nicht dabei?
 Kein Problem - individuell auf Anfrage erhältlich!**

Andere Profilfarben, farbige Silikoneinlagen, andere Füllungen, verlegefertige T- oder X-Dehnungsfugenkreuze, u.v.m. fertigen wir gern für Sie individuell nach Ihren Wünschen!

Your desired compilation was not included? No problem - individually available on request! We would be happy to manufacture other leg colours, coloured silicone inserts, other fillings, ready-to-lay T or X expansion spacers and much more according to your wishes!



Bild 1: Glittervarianten mit schwarzer Silikonbasis
 Image 1: Glitter variants with a black silicone base



Bild 2: Dehnungsfugenprofil h=2,5 mm mit breiten Auflegeschenkeln mit schwarzer Silikoninlage
 Image 2: Expansion joint profile h=2,5 mm with wide support legs with black silicone insert



Bild 3 : T-Dehnungsfugenkreuz
 Image 3: T-expansion joint cross



Bild 4 : X-Dehnungsfugenkreuz
 Image 4: x-expansion joint cross

Spezial-Dehnungsfugenprofil

special expansion gap profile

Innenmaß/ inside measure						
Material/ material	L / l (m)	Stk./VE / pcs/unit	Höhe/ height h (mm)	Art./ref.	€/m	€/Stück/ pcs.

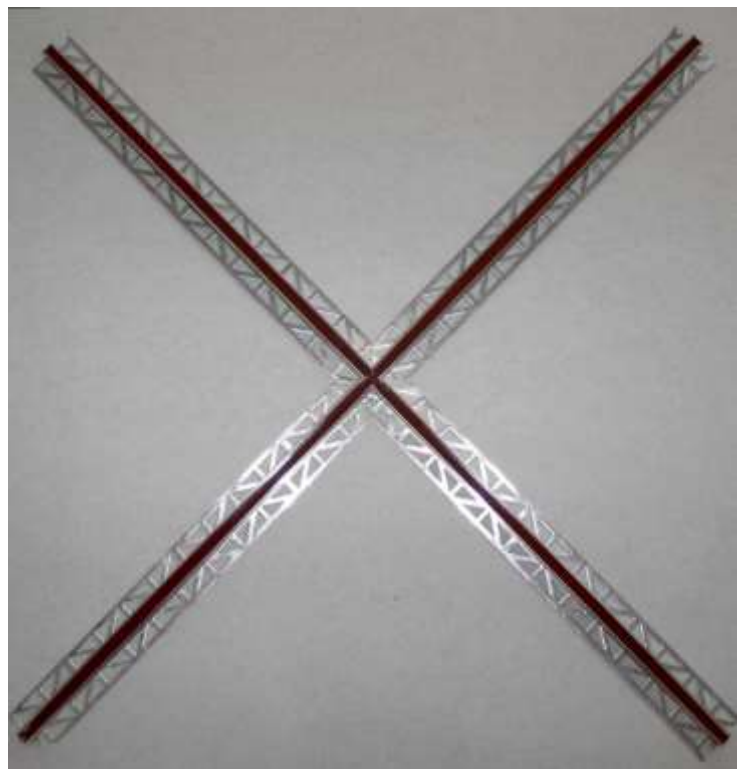
322 Spezial-Dehnungsfugenprofil, Fugenbreite bis 20 mm, gebohrt

expansion gap profile,
joint width up to 20 mm,
drilled

für starke Belastungen
for heavy loads

Aluminium pressblank aluminium mill-finish	2,5 m	10	2,2	37728-3	37,12/m	92,82
			2,8	37730-6	38,24/m	95,58
			3,7	37768-9	39,60/m	99,00
			5	37770-2	41,40/m	103,48

**Füllbereich 10 mm,
gefüllt mit grauem Silikon**
filling area 10 mm,
filled with grey silicone

**andere Fugenbreiten auf
Anfrage gegen Aufpreis (15%)
möglich/** other joint widths on
request for an additional charge
(15%) possible

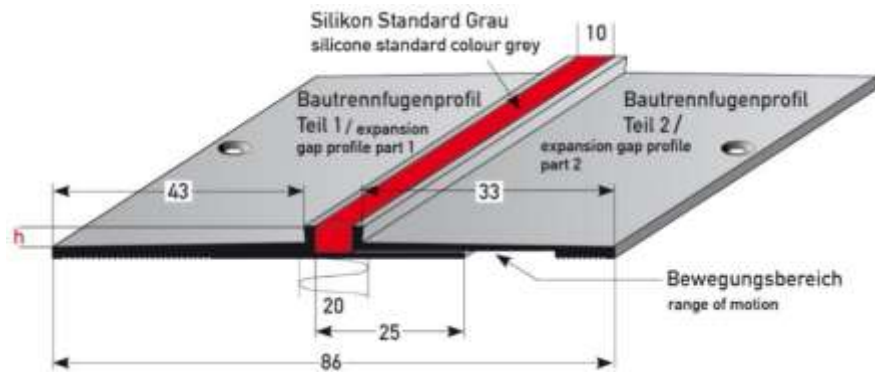

479 Spezial-Dehnungsfugenpr., 3-dimensional beweglich, Fugenbreite bis 20 mm, gebohrt

expansion gap profile,
joint width up to 20 mm,
drilled, 3-dimensionally
movable

für starke Belastungen
for heavy loads

**Füllbereich 10 mm,
gefüllt mit grauem Silikon**
filling area 10 mm,
filled with grey silicone

Aluminium pressblank aluminium mill-finish	2,5	10	2,2	70896-4	37,12/m	92,82
			2,8	70898-8	38,24/m	95,58

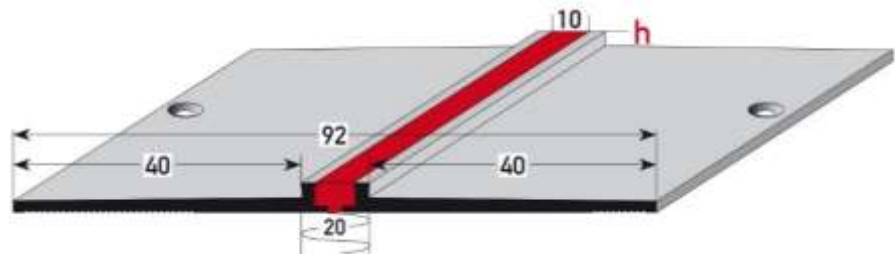

Farbige Silikoneinlagen nach Farbauswahl von Otto Chemie, sowie RAL und NCS:

choice of colours by Otto Chemie, RAL colours and NCS:

- ≤ 12,5 m je Farbe/ ≤ 12,5 m of a colour --> **+48,50 €** Preisaufschlag pauschal/ +48,50 € flat rate surcharge
- ≤ 25 m je Farbe/ ≤ 25m of a colour --> **+30 %** Preisaufschlag/ +30 % surcharge
- > 25 m je Farbe/ > 25m of a colour --> **+20 %** Preisaufschlag/ +20 % surcharge
- ≥ 100 m je Farbe/ ≥ 100m of a colour --> **kein** Preisaufschlag/ no surcharge

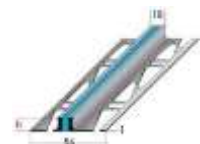

Lieferzeit auf Anfrage/ delivery time on request

Dehnungsfugenprofile "SUPER 20" für nachträglichen Einbau

expansion gap profile "SUPER 20" - for subsequent installation

Material/ material	L / l (m)	Stk./VE / pcs/unit	Belaghöhe/ flooring height (mm)	Art./ref.	€/m	€/Stück/ pcs.
-----------------------	-----------	-----------------------	---------------------------------------	-----------	-----	------------------

323 Dehnungsfugenprofil TYP 20/12, für über 20 mm Fugenbreite, gebohrt,
 mit grauer PVC-Einlage, für nachträglichen Einbau, zum Aufsetzen auf den Bodenbelag

expansion gap profile type 20/12, for over 20 mm joint width, drilled, with grey PVC insert, for subsequent installation, to be placed on the flooring

Aluminium pressblank aluminium mill-finish	2,0 m	10	-	37734-4	80,52/m	161,04
	4,0 m*			37736-8		322,10

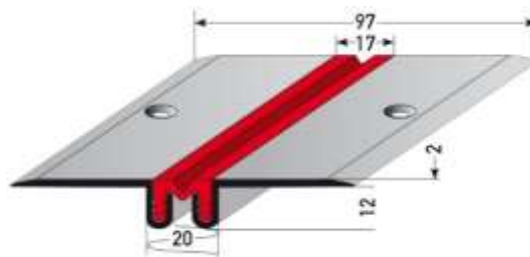

324 Dehnungsfugenprofil TYP 20/12/3, für über 20 mm Fugenbreite, gebohrt,
 mit grauer PVC-Einlage, für nachträglichen Einbau, zum Anstoßen von 3 mm Belag

expansion gap profile type 20/12/3, for over 20 mm joint width, drilled, with grey PVC insert, for subsequent installation, for abutting 3 mm flooring

Aluminium pressblank aluminium mill-finish	2,0 m	10	3 mm	37740-5	81,88/m	163,76
	4,0 m*			37742-9		327,50

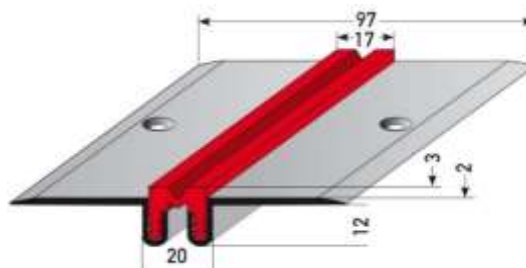

482 Dehnungsfugenprofil TYP 20/12/5, für über 20 mm Fugenbreite, gebohrt,
 mit grauer PVC-Einlage, für nachträglichen Einbau, zum Anstoßen von 5 mm Belag

expansion gap profile type 20/12/5, for over 20 mm joint width, drilled, with grey PVC insert, for subsequent installation, for abutting 5 mm flooring

Aluminium pressblank aluminium mill-finish	2,0 m	10	5 mm	70976-3	81,88/m	163,76
	4,0 m*			70978-7		327,50

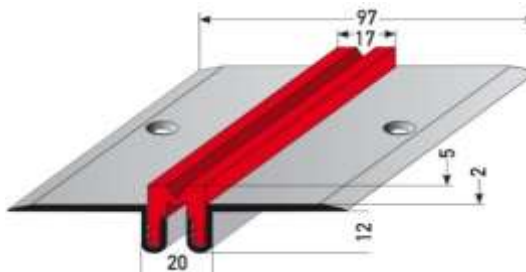

* 4,0 m-Ware ist nur per Spedition lieferbar (gesonderte Transportkosten)
 4,0 m profiles are only available per forwarding agency (separate transport costs)

Dehnungsfugenprofile "SUPER 35" für nachträglichen Einbau

expansion gap profile "SUPER 35" - for subsequent installation

Material/ material	L / l (m)	Stk./VE / pcs/unit	Belaghöhe/ flooring height (mm)	Art./ref.	€/m	€/Stück/ pcs.
-----------------------	-----------	-----------------------	---------------------------------------	-----------	-----	------------------

325 Dehnungsfugenprofil TYP 35/15, für über 35 mm Fugenbreite, gebohrt,
 mit grauer PVC-Einlage, für nachträglichen Einbau, zum Aufsetzen auf den Bodenbelag

expansion gap profile type 35/15, for over 35 mm joint width, drilled, with grey PVC insert, for subsequent installation, to be placed on the flooring

Aluminium pressblank aluminium mill-finish	2,0 m	10	-	37746-7	109,94/m	219,86
	4,0 m*			37748-1		439,72

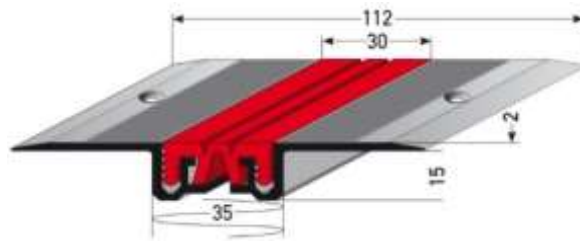

326 Dehnungsfugenprofil TYP 35/15/3, für über 35 mm Fugenbreite, gebohrt,
 mit grauer PVC-Einlage, für nachträglichen Einbau, zum Anstoßen von 3 mm Belag

expansion gap profile type 35/15/3, for over 35 mm joint width, drilled, with grey PVC insert, for subsequent installation, for abutting 3 mm flooring

Aluminium pressblank aluminium mill-finish	2,0 m	10	3 mm	37752-8	111,74/m	223,48
	4,0 m*			37754-2		446,96

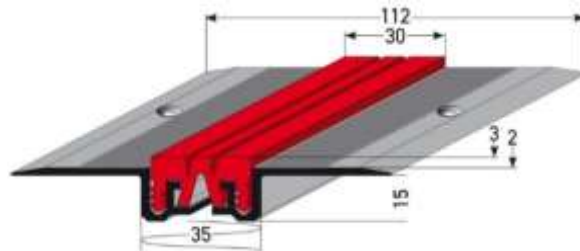

484 Dehnungsfugenprofil TYP 35/15/5, für über 35 mm Fugenbreite, gebohrt,
 mit grauer PVC-Einlage, für nachträglichen Einbau, zum Anstoßen von 5 mm Belag

expansion gap profile type 35/15/5, for over 35 mm joint width, drilled, with grey PVC insert, for subsequent installation, for abutting 5 mm flooring

Aluminium pressblank aluminium mill-finish	2,0 m	10	5 mm	70982-4	111,74/m	223,48
	4,0 m*			70984-8		446,96

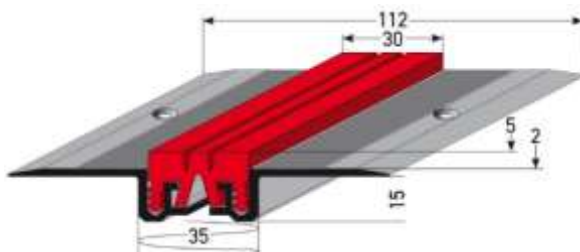

* 4,0 m-Ware ist nur per Spedition lieferbar (gesonderte Transportkosten)
 4,0 m profiles are only available per forwarding agency (separate transport costs)

9. FLIESENTRENN-, DEHNUNGSFUGEN-, BAU- & T-PROFILE/ 9. CERAMIC TILE SEPARATION, EXPANSION GAP, BUILDING + T-PROFILES

andere Längen+Abmessungen auf Anfrage/
other lengths and dimensions on demand

Lagerlängen à 6 m
in stock lengths à 6 m

170 Winkelprofil

angle edge

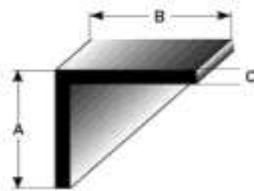

Aluminium-Bauprofile pressblank (Außenmaße)

aluminium building profiles mill-finish (outside measures)

L / l (m)	VE / unit	AxBxC mm	Art./ref.	€/Stück/pcs.
1,0	10	10 x 10 x 2	37120-5	5,80
		15 x 15 x 2	37122-9	6,32
		20 x 20 x 2	37130-4	6,78
		25 x 25 x 2	37132-8	8,36
		30 x 30 x 2	37140-3	9,98
2,0	10	10 x 10 x 2	37150-2	11,60
		15 x 15 x 2	37152-6	12,60
		20 x 20 x 2	37160-1	13,40
		25 x 25 x 2	37162-5	16,74
		30 x 30 x 2	37170-0	19,82

171 U-Profil

U-profile

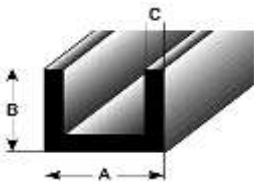

1,0	10	10 x 10 x 2	37180-9	8,72
		15 x 15 x 2	37182-3	9,12
		20 x 20 x 2	37190-8	9,56
		30 x 30 x 3	37200-4	21,80
2,0	10	10 x 10 x 2	37210-3	17,44
		15 x 15 x 2	37212-7	18,26
		20 x 20 x 2	37220-2	19,18
		30 x 30 x 3	37230-1	43,46

172 T-Profil

T-profile

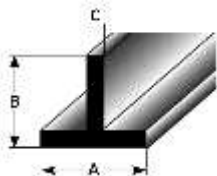

1,0	10	20 x 20 x 2	37240-0	10,68
		25 x 25 x 3	37250-9	12,16
		30 x 30 x 3	37260-8	15,02
2,0	10	20 x 20 x 2	37270-7	21,34
		25 x 25 x 3	37280-6	24,28
		30 x 30 x 3	37290-5	30,00

173 Rohr

pipe

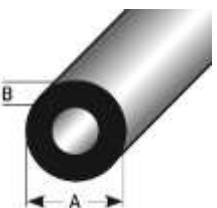

1,0	10	10 x 1	37300-1	5,50
		12 x 1	37310-0	6,52
		16 x 2	37320-9	7,64
2,0	10	10 x 1	37330-8	11,12
		12 x 1	37340-7	13,06
		16 x 2	37350-6	15,40

174 Flachprofil

flat profile



1,0	10	10 x 2	37360-5	2,90
		15 x 2	37362-9	4,38
		20 x 2	37364-3	5,82
		30 x 2	37370-4	6,94
		40 x 3	37380-3	10,22
2,0	10	10 x 2	37390-2	5,80
		15 x 2	37392-6	8,74
		20 x 2	37394-0	11,68
		30 x 2	37400-8	13,96
		40 x 3	37410-7	20,42

175 Vierkantrohr

rectangular pipe

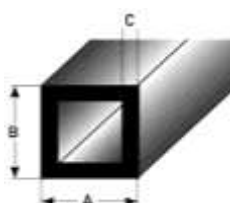

1,0	10	15 x 15 x 1,5	37420-6	12,82
		20 x 20 x 2	37430-5	16,98
		30 x 30 x 3	37440-4	28,96
2,0	10	15 x 15 x 1,5	37450-3	25,52
		20 x 20 x 2	37460-2	34,04
		30 x 30 x 3	37470-1	57,92

9. FLIESENTRENN-, DEHNUNGSFUGEN-, BAU- & T-PROFILE/ 9. CERAMIC TILE SEPARATION, EXPANSION GAP, BUILDING + T-PROFILES

* kann 40 mm Klemmstelle vom Eloxieren enthalten/
 may contain 40 mm clamping point from anodizing

178 Winkelprofil gleichschenkelig

Aluminium silber eloxiert
 angle edge, equal size sides,
 aluminium silver anodized



Aluminium-Bauprofile silber eloxiert (Außenmaße)				
aluminium building profiles silver anodized (outside measures)				
L / l (m)	VE / unit	AxBxC mm	Art./ref.	€/Stück/ pcs.
1,0 m*	10	10 x 10 x 1	45000-9	4,18
		15 x 15 x 1	45002-3	5,76
		20 x 20 x 1,5	45004-7	7,92
		25 x 25 x 1,5	45006-1	9,78
		30 x 30 x 1,5	45008-5	11,84
2,0 m*	10	40 x 40 x 1,5	45010-8	15,86
		10 x 10 x 1	45016-0	8,36
		15 x 15 x 1	45018-4	11,54
		20 x 20 x 1,5	45020-7	15,86
		25 x 25 x 1,5	45022-1	19,58
		30 x 30 x 1,5	45024-5	23,70
		40 x 40 x 1,5	45026-9	31,66

179 Winkelprofil ungleichschenkelig

Aluminium silber eloxiert
 angle edge, different size sides
 aluminium silver anodized



1,0 m*	10	15 x 10 x 1	45032-0	4,86
		20 x 15 x 1,5	45034-4	6,92
		25 x 15 x 1,5	45036-8	7,82
		30 x 20 x 1,5	45038-2	9,94
		40 x 20 x 1,5	45040-5	11,84
2,0 m*	10	15 x 10 x 1	45046-7	9,66
		20 x 15 x 1,5	45048-1	13,88
		25 x 15 x 1,5	45050-4	15,58
		30 x 20 x 1,5	45052-8	19,78
		40 x 20 x 1,5	45054-2	23,70

andere Längen + Abmessungen auf Anfrage/ other lengths and dimensions on demand

Lagerlängen à 6 m
 in stock lengths à 6 m

9. FLIESENTRENN-, DEHNUNGSFUGEN-, BAU- & T-PROFILE/ 9. CERAMIC TILE SEPARATION, EXPANSION GAP, BUILDING + T-PROFILES

**** inklusive 40 mm Klemm-
stelle an einer Seite vom
Eloxieren/ including 40 mm
clamping point on one side
from anodizing**

T - Profile					
T - profiles					
Material+Farbe/ material+colour	Höhe/ height	L / l (m)	Art./ref.	€/m	€/Stück/ pcs.

583 Mini-T-Profil 14 x 2,2 mm, Aluminium, ungebohrt, SB-verpackt

mini T-profile 14 x 2,2 mm,
aluminium, undrilled,
self-service-packaging



silberfarbig silver	2,2 mm	2,7 m	72962-4	7,18	19,40
edelstahlfarbig stainless steel coloured			72964-8	9,48	25,62
schwarz black			72966-2	9,62	25,96

**2 5 T-Profil 14 x 7 mm
für Übergänge**

T-profile 14 mm for transition

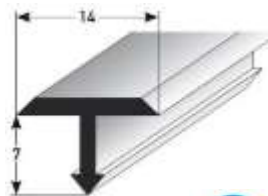

Messing ziehblank brass mill-finish	7 mm	2,5 m	36380-4	16,52	41,30
Aluminium blank alu mill-finish			36390-3	4,16	10,40
Alu silber alu silver			46630-7	6,42	16,04
Alu gold alu gold		2,5 m**	46632-1	7,38	18,44
Alu bronze hell alu bonze light			46634-5	8,94	22,34
Alu bronze dunkel alu bonze dark			46636-9	8,94	22,34
Edelstahl matt stainless steel matt	7 mm	1,0 m	72362-2	16,54	16,54
		2,5 m	36420-7	16,54	41,36
		3,0 m *	72364-6	16,54	49,62

*** 3,0 m-Ware ist nur per Spedition lieferbar (gesonderte Transportkosten)**
3,0 m profiles are only available per forwarding agency (separate transport costs)

**2 6 T-Profil 25 mm
für Übergänge**

T-profile 25 mm for transition

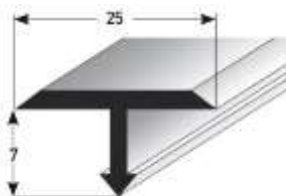

Messing ziehblank brass mill-finish	7 mm	2,5 m	36400-9	46,20	115,48
Aluminium blank alu mill-finish			36410-8	8,90	22,24
Alu silber alu silver			46640-6	11,38	28,44
Alu gold alu gold		2,5 m**	46642-0	12,82	32,06
Alu bronze hell alu bonze light			46644-4	14,52	36,32
Alu bronze dunkel alu bonze dark			46646-8	14,52	36,32
Edelstahl matt stainless steel matt	7 mm	1,0 m	72366-0	22,12	22,12
		2,5 m	36430-6	22,12	55,28
		3,0 m *	72368-4	22,12	66,34

*** 3,0 m-Ware ist nur per Spedition lieferbar (gesonderte Transportkosten)**
3,0 m profiles are only available per forwarding agency (separate transport costs)



Profil biegen - auf Anfrage
bent profile - on request

483 Befestigungsdübel für T-Profile, Nr. 25 + 26

fixing dowel for T-profiles,
no. 25 + 26

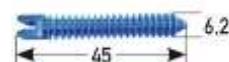

Abmaß/dimension	Stk./Verpack. pcs./pack	Art./ref.	€/Btl./bag
45 x 6,2 mm	Btl./bag à 10	70988-6	22,30

10. LÄUFERSTANGEN AUS MESSING & EDELSTAHL

10. STAIR RODS OUT OF BRASS + STAINLESS STEEL



10. LÄUFERSTANGEN/ 10. STAIR RODS

Achtung: Der Aufpreis für die Anfertigung von Sonderlängen beträgt generell 15% zuzügl. Verschnitt!

Note: There is a 15% surcharge for special length cuts plus waste!

Der Läuferstangendurchmesser ist nach Läuferart und Verlegetechnik zu wählen! Wir beraten Sie gern!

Stair rod diameter should be selected according to type of carpet and laying technology! We advise you gladly!

Läuferstange Ø 10 mm

stair rod Ø 10 mm

Material/material	L / l (m)	Art./ref.	€
-------------------	-----------	-----------	---

7 4 Läuferstange Ø 10 x 0,8 mm Messing/ stair rod Ø 10 x 0,8 mm brass

Abschlussknöpfe werden in die Gesamtlänge eingerechnet
endings are included in the full length



Messing-Rohr poliert, lackiert, inkl. Messingabschlussknöpfe brass pipe, polished, painted, with brass-endings	0,75	05770-3	12,94
	0,8	05780-2	13,76
	0,9	05790-1	15,48
	1,0	05800-7	17,14
	1,1	05810-6	18,96
	1,2	05820-5	20,58
Messing-Rohr mit Stahlkern poliert, lackiert, inkl. Messingabschlussknöpfe brass pipe with steel core, polished, painted, with brass-endings	1,3	05830-4	22,32
	0,75	05813-7	15,04
	0,8	05814-4	16,06
	0,9	05815-1	18,00
	1,0	05816-8	20,08
	1,1	05817-5	22,12
1,2	05818-2	24,12	
1,3	05819-9	26,00	

371 Läuferstange Ø 10 x 1,5 mm Edelstahl poliert/ stair rod Ø 10 x 1,5 mm stainless steel polished

Abschlussknöpfe werden in die Gesamtlänge eingerechnet
endings are included in the full length



Edelstahl-Rohr poliert inkl. vernickelter Abschlussknöpfe stainless steel pipe polished, with nickel plated endings	0,75	66346-1	17,40
	0,8	66348-5	18,54
	0,9	66350-8	20,02
	1,0	66352-2	22,30
	1,1	66354-6	24,52
	1,2	66356-0	26,76
	1,3	66358-4	28,98

7 5 Läuferstange Ø 10 x 1,5 mm Edelstahl matt/ stair rod Ø 10 x 1,5 mm stainless steel matt

Abschlussknöpfe werden in die Gesamtlänge eingerechnet
endings are included in the full length



Edelstahl-Rohr matt inkl. matter vernickelter Abschlussknöpfe stainless steel pipe matt, with mat nickel plated endings	0,75	38820-3	13,32
	0,8	38830-2	14,22
	0,9	38840-1	15,96
	1,0	05450-4	17,80
	1,1	38850-0	19,54
	1,2	38860-9	21,34
	1,3	38870-8	23,10

429 Läuferstange Ø 10 x 0,8 mm Messing brüniert/ stair rod Ø 10 x 0,8 mm brass burnished

Abschlussknöpfe werden in die Gesamtlänge eingerechnet
endings are included in the full length

Messing-Rohr brüniert, mit Stahlkern inkl. brüniertes Abschlussknöpfe burnished brass pipe, with steel core, with burnished brass-endings	1,0	05100-8	29,94
---	-----	---------	-------

Brünier-Farbtone kann variieren/ colour of burnished brass can vary

Lieferzeit auf Anfrage/ delivery time on request

7 6 Stahl-Läuferstange mit Dekorbeschichtung Ø 10 x 1,5 mm

steel stair rod with decor coating
Ø 10 x 1,5 mm

inkl. Messingabschlussknöpfe
with brass endings

schwarz matt/ black matt	1,0	05300-2	13,86
Kupfer antik/ copper antik		05350-7	
weiß/ white		05400-9	

Nicht für den Außenbereich geeignet/ not suitable for outdoor use

10. LÄUFERSTANGEN/ 10. STAIR RODS

Zubehör für Läuferstange Ø 10 mm

accessories for stair rod Ø 10 mm

189 Kugelöse für Läuferstange Ø 10 mm, gedreht/ ball eyelet for stair rod Ø 10 mm, twisted

gedrehte Ausführung mit
Stockschraube M4
twisted execution with hanger bolt M4



Feststellschraube/
locking screw

Brünier-Farbton kann variieren
colour of burnished brass can vary

Lieferzeit für brüniert auf Anfrage/
delivery time for burnished brass on
request

Material/material	Abpackung/ unit	Art./ref.	€
Messing , poliert, lackiert brass, polished, painted	1 Stück /pcs.	05500-6	2,22/St./pcs.
Messing mit Feststellschraube , poliert, lackiert, brass with locking screw, polished, painted,	1 Stück /pcs.	05700-0	3,66/St./pcs.
vernickelt nickel plated	1 Stück /pcs.	05600-3	2,58/St./pcs.
vernickelt mit Feststellschraube nickel plated with locking screw	1 Stück /pcs.	05705-5	3,96/St./pcs.
vernickelt matt nickel plated mat	1 Stück /pcs.	38890-6	5,32/St./pcs.
vernickelt matt mit Feststellschraube nickel plated mat with locking screw	1 Stück /pcs.	38900-2	6,68/St./pcs.
brüniert burnished brass	1 Stück /pcs.	05710-9	5,40/St./pcs.
brüniert mit Feststellschraube burnished brass with locking screw	1 Stück /pcs.	05720-8	6,84/St./pcs.

Kugelöse Ø 10 mm, gegossen / ball eyelet Ø 10 mm casted

Messing poliert, lackiert brass polished, painted	1 Stück /pcs.	39310-8	1,84/St./pcs.
vernickelt nickel plated	1 Stück /pcs.	39312-2	2,12/St./pcs.

Eindrehwerkzeug für Kugelösen 10 mm, Messing/ tool for ball eyelets 10 mm, brass

zur Verwendung im Akkuschauber/ for use in electric drills

39150-0	43,32/St./pcs.
---------	----------------

73 Klappöse Ø 10 mm, offen/ folding eyelet Ø 10 mm, open

inkl. Schrauben + Dübel
incl. screws + dowels



Brünier-Farbton kann variieren/
colour of burnished brass can vary

Messing poliert, lackiert brass polished, painted	1 Paar/pair	05030-8	20,94/Paar/pair
vernickelt nickel plated	1 Paar/pair	05031-5	27,48/Paar/pair
vernickelt matt nickel plated mat	1 Paar/pair	38910-1	39,10/Paar/pair
brüniert burnished brass	1 Paar/pair	05050-6	31,12/Paar/pair

Lieferzeit für brüniert auf Anfrage/ delivery time for burnished brass on request

190 Klappöse Ø 10 mm, geschlossen/ folding eyelet Ø 10 mm, closed

inkl. Schrauben + Dübel
incl. screws + dowels



Brünier-Farbton kann variieren/
colour of burnished brass can vary

Messing poliert, lackiert brass polished, painted	1 Paar/pair	05040-7	20,94/Paar/pair
vernickelt nickel plated	1 Paar/pair	05041-4	27,48/Paar/pair
vernickelt matt nickel plated mat	1 Paar/pair	38920-0	39,10/Paar/pair
brüniert burnished brass	1 Paar/pair	05060-5	31,12/Paar/pair

Lieferzeit für brüniert auf Anfrage/ delivery time for burnished brass on request

10. LÄUFERSTANGEN/ 10. STAIR RODS

Achtung: Der Aufpreis für die Anfertigung von Sonderlängen beträgt generell 15% zuzügl. Verschnitt!

Note: There is a 15% surcharge for special length cuts plus waste!

Der Läuferstangendurchmesser ist nach Läuferart und Verlegetechnik zu wählen! Wir beraten Sie gern!

Stair rod diameter should be selected according to type of carpet and laying technology! We advise you gladly!

Quattro-Läuferstange 10 x 10 mm

quattro stair rod 10 x 10 mm

Material/material	L / l (m)	Art./ref.	€
-------------------	-----------	-----------	---

586 Quattro-Läuferstange 10 x 10 x 1,0 mm, Edelstahl matt

quattro stair rod 10 x 10 x 1,0 mm,
stainless steel mat



mattes Edelstahl-Vierkanrohr inkl. matt vernickelter, quadratischer Abschlussknöpfe stainless steel pipe, with mat nickle-plated square endings			
	0,75	72996-9	35,64
	0,8	72998-3	38,02
	0,9	73000-2	42,78
	1,0	73002-6	47,52
	1,1	73004-0	52,28
	1,2	73006-4	57,04
	1,3	73008-8	61,78

Abschlussknöpfe werden in die Gesamtlänge eingerechnet /
endings are included in the full length

587 Kugelöse für Quattro-Läuferstange, gedreht

ball eyelet for quattro stair rod,
twisted



Material/material	Abpackung/ unit	Art./ref.	€
vernickelt matt nickel plated mat	1 Stück /pcs.	73012-5	11,16/St./pcs.
vernickelt matt mit Feststellschraube nickel plated mat with locking screw	1 Stück /pcs.	73014-9	12,54/St./pcs.

**gedrehte Ausführung mit Stockschraube M4 und 8-eckiger Einsteckmöglichkeit
für gerade und diagonale Befestigung der Läuferstange /**

twisted execution with hanger bolt M4 and octagonal insertion option for straight and diagonal fastening of the stair rod



10. LÄUFERSTANGEN/ 10. STAIR RODS

Achtung: Der Aufpreis für die Anfertigung von Sonderlängen beträgt generell 15% zuzügl. Verschnitt!

Note: There is a 15% surcharge for special length cuts plus waste!

Der Läuferstangendurchmesser ist nach Läuferart und Verlegetechnik zu wählen! Wir beraten Sie gern!

Stair rod diameter should be selected according to type of carpet and laying technology! We advise you gladly!

Läuferstange 13 mm			
stair rod Ø 13 mm			
Material/material	L / l (m)	Art./ref.	€

197 Läuferstange Ø 13 x 1,0 mm Messing/ stair rod Ø 13 x 1,0 mm brass

Abschlussknöpfe werden in die Gesamtlänge eingerechnet
 endings are included in the full length



Messing-Rohr poliert, lackiert, inkl. Abschlussknöpfe brass pipe, polished, painted, incl. endings	L / l (m)	Art./ref.	€
	0,9	05822-9	24,22
	1,0	05823-6	26,84
	1,2	05824-3	32,26
Messing-Rohr mit Stahlkern, poliert, lack., inkl. Abschlussknöpfe brass pipe with steel core, polished, painted, incl. endings	L / l (m)	Art./ref.	€
	0,9	39100-5	31,64
	1,0	39110-4	35,12
	1,5	39120-3	52,58

379 Läuferstange Ø 13 x 1,0 mm Edelstahl poliert/ stair rod Ø 13 x 1,0 mm stainless steel polished

Abschlussknöpfe werden in die Gesamtlänge eingerechnet
 endings are included in the full length



Edelstahl-Rohr poliert inkl. vernickelter Abschlussknöpfe stainless steel pipe, polished, incl. endings	L / l (m)	Art./ref.	€
	0,9	66466-6	25,36
	1,0	66468-0	28,12
	1,2	66472-7	33,74
Edelstahl-Rohr poliert mit Stahlkern, inkl. vernickelter Abschlussknöpfe stainless steel pipe, polished, with steel core, incl. endings	L / l (m)	Art./ref.	€
	0,9	66482-6	32,24
	1,0	66484-0	35,30
	1,5	66490-1	55,34

430 Läuferstange Ø 13 x 1,0 mm Edelstahl matt/ stair rod Ø 13 x 1,0 mm stainless steel mat

Abschlussknöpfe werden in die Gesamtlänge eingerechnet
 endings are included in the full length



Edelstahl-Rohr matt inkl. matter vernickelter Abschlussknöpfe stainless steel pipe, mat, incl. mat endings	L / l (m)	Art./ref.	€
	0,9	67538-9	24,06
	1,0	67540-2	26,76
	1,2	67544-0	32,06
Edelstahl-Rohr matt mit Stahlkern, inkl. matter vernickelter Abschlussknöpfe stainless steel pipe, mat, with steel core, incl. mat endings	L / l (m)	Art./ref.	€
	0,9	67554-9	30,52
	1,0	67556-3	33,90
	1,5	67560-0	50,90

431 Läuferstange Ø 13 x 1,0 mm Messing brüniert/ stair rod Ø 13 x 1,0 mm brass burnished

Abschlussknöpfe werden in die Gesamtlänge eingerechnet
 endings are included in the full length

Brünier-Farbtone kann variieren/ colour of burnished brass can vary

Messing-Rohr brüniert inkl. brüniertes Abschlussknöpfe burnished brass pipe, with burnished brass-endings	L / l (m)	Art./ref.	€
	1,0	67576-1	36,38
Messing-Rohr brüniert mit Stahlkern inkl. brüniertes Abschlussknöpfe burnished brass pipe with steel core, with burnished brass-endings	L / l (m)	Art./ref.	€
	1,0	67592-1	44,64

Lieferzeit auf Anfrage/ delivery time on request

10. LÄUFERSTANGEN/ 10. STAIR RODS

Zubehör für Läuferstange Ø 13 mm

accessories for stair rod Ø 13 mm

198 Kugelöse 13 mm, gedreht/ ball eyelet 13 mm, twisted

gedrehte Ausführung mit
Stockschraube M4
twisted execution with
hanger bolt M4



Feststellschraube/
locking screw

**Brünier-Farbtön kann
variieren/** colour of burnished
brass can vary

Material/material	Abpackung/ unit	Art./ref.	€
Messing poliert, lackiert brass, polished, painted	1 Stück /pcs.	05825-0	4,52/St./pcs.
Messing mit Feststellschraube , poliert, lackiert, brass with locking screw, polished, painted	1 Stück /pcs.	05850-2	7,22/St./pcs.
vernickelt nickel plated	1 Stück /pcs.	39230-9	6,98/St./pcs.
vernickelt mit Feststellschraube/ nickel plated, with locking screw	1 Stück /pcs.	39235-4	11,18/St./pcs.
vernickelt matt nickel plated mat	1 Stück /pcs.	39238-5	7,16/St./pcs.
vernickelt matt mit Feststellschraube nickel plated mat with locking screw	1 Stück /pcs.	39239-2	11,34/St./pcs.
brüniert burnished brass	1 Stück /pcs.	39236-1	7,82/St./pcs.
brüniert mit Feststellschraube burnished brass with locking screw	1 Stück /pcs.	39237-8	10,50/St./pcs.

Lieferzeit für brüniert auf Anfrage/ delivery time for burnished brass on request

Eindrehwerkzeug für Kugelösen 13 mm, Messing/ tool for ball eyelets 13 mm, brass

zur Verwendung im Akkuschauber/ for use in electric drills

72254-0 56,30/St./pcs.

199 Klappöse Ø 13 mm, offen/ folding eyelets Ø 13 mm brass, open

inkl. Schrauben + Dübel
incl. screws + dowels



**Brünier-Farbtön kann
variieren/** colour of burnished
brass can vary

Messing poliert, lackiert brass, polished, painted	1 Paar/pair	39130-2	27,18/Paar/pair
vernickelt nickel plated	1 Paar/pair	39240-8	32,82/Paar/pair
vernickelt matt nickel plated mat	1 Paar/pair	39131-9	44,48/Paar/pair
brüniert burnished brass	1 Paar/pair	39132-6	37,34/Paar/pair

Lieferzeit für brüniert auf Anfrage/ delivery time for burnished brass on request

200 Klappöse Ø 13 mm, geschlossen/ folding eyelets Ø 13 mm brass, closed

inkl. Schrauben + Dübel
incl. screws + dowels



**Brünier-Farbtön kann
variieren/** colour of burnished
brass can vary

Messing poliert, lackiert brass, polished, painted	1 Paar/pair	39140-1	27,18/Paar/pair
vernickelt nickel plated	1 Paar/pair	39245-3	32,82/Paar/pair
vernickelt matt nickel plated mat	1 Paar/pair	39141-8	44,48/Paar/pair
brüniert burnished brass	1 Paar/pair	39142-5	37,34/Paar/pair

Lieferzeit für brüniert auf Anfrage/ delivery time for burnished brass on request

10. LÄUFERSTANGEN/ 10. STAIR RODS

Achtung: Der Aufpreis für die Anfertigung von Sonderlängen beträgt generell 15% zuzügl. Verschchnitt!

Note: There is a 15% surcharge for special length cuts plus waste!

Der Läuferstängendurchmesser ist nach Läuferart und Verlegetechnik zu wählen! Wir beraten Sie gern!

Stair rod diameter should be selected according to type of carpet and laying technology! We advise you gladly!

Zubehör für Läuferverlegung

accessories for runners laying

Material/material	Art./ref.	Abpackung/unit	€
-------------------	-----------	----------------	---

68 Teppichschraube mit Metallbuchse, 3/16 Zoll, Bohrdurchmesser: 6,5-7 mm

carpet screw with metal casing, 3/16 inch, drill diameter: 6.5-7 mm



Messing brass	20562-3	SB-Beutel à 10 Stk./ self-service bag à 10 pcs.	37,80/Btl./bag
	20561-6	Karton à 50 Stk./ box à 50 pcs.	181,54/Kart./box
vernickelt nickel plated	20565-4	Karton à 50 Stk./ box à 50 pcs.	192,46/Kart./box

Unterlegscheibe für Teppichschraube/ washer for carpet screw



Messing brass	20563-0	SB-Beutel à 10 Stk./ self-service bag à 10 pcs.	12,16/Btl./bag
	20564-7	Karton à 50 Stk./ box à 50 pcs.	43,64/Kart./box
vernickelt nickel plated	20566-1	Karton à 50 Stk./ box à 50 pcs.	46,86/Kart./box

69 Teppichnagel/ carpet nail



messingfarben 3,0 x 30 brass coloured 3,0 x 30	20574-6	SB-Beutel à 10 Stk./ self-service bag à 10 pcs.	5,72/Btl./bag
	20570-8	Karton à 100 Stk./ box à 100 pcs.	31,66/Kart./box
vernickelt 3,0 x 30 nickel plated 3,0 x 30	20582-1	SB-Beutel à 10 Stk./ self-service bag à 10 pcs.	6,22/Btl./bag
	20578-4	Karton à 100 Stk./ box à 100 pcs.	36,82/Kart./box

Dreikantläuferstange 16 x 16 mm

triangular stair rod 16 x 16 mm

Material/material	L / l (m)	Art./ref.	€
-------------------	-----------	-----------	---

70 Dreikantläuferstange 16 x 16 mm/ triangular stair rod 16 x 16 mm



Brünier-Farbton kann variieren/ colour of burnished brass can vary

Eisenrohr mit nahtlosem Messing-Überzug , poliert, lackiert steel pipe, brass plated, polished, painted	1,0	05003-2	28,28
	2,5	05000-1	70,70
vernickelt nickel plated	1,0	05002-5	42,10
	2,5	05001-8	105,50
brüniert burnished brass	1,0	05006-3	46,96
	2,5	05007-0	117,36

Nicht für den Außenbereich geeignet/ not suitable for outdoor use

Zubehör für Dreikantläuferstange 16 x 16 mm

accessories for triangular stair rod 16 x 16 mm

Material/material	Art./ref.	Abpackung/unit	€
-------------------	-----------	----------------	---

180 Dreikantklappöse 16 x 16 mm, geschlossen/ triangular folding eyelets 16 x 16 mm, closed

inkl. Dübel & Schrauben
incl. screws + dowels



Messing poliert, lackiert brass polished, painted	05020-9	1 Paar/ pair	28,32/Paar/pair
vernickelt nickel plated	05021-6	1 Paar/ pair	37,14/Paar/pair
brüniert burnished brass	05022-3	1 Paar/ pair	39,10/Paar/pair

Brünier-Farbton kann variieren/ colour of burnished brass can vary

10. LÄUFERSTANGEN/ 10. STAIR RODS

Achtung: Der Aufpreis für die Anfertigung von Sonderlängen beträgt generell 15% zuzügl. Verschnitt!

Note: There is a 15% surcharge for special length cuts plus waste!

Der Läuferstangendurchmesser ist nach Läuferart und Verlegetechnik zu wählen! Wir beraten Sie gern!

Stair rod diameter should be selected according to type of carpet and laying technology! We advise you gladly!

Läuferstange Ø 16 mm

stair rod Ø 16 mm

Material/material	L / l (m)	Art./ref.	€
-------------------	-----------	-----------	---

71 Läuferstange Ø 16 x 3 mm Messing/ stair rod Ø 16 x 3 mm brass

poliert, lackiert, 3 mm Wandstärke, ohne Abschlussknöpfe
 polished, painted, 3 mm walls, without endings

1,0	05451-1	61,60
-----	---------	-------

**Die Fertigung erfolgt objektbezogen/
 manufactured on customers order**









Länge = Rohrlänge **ohne** Abschlussknöpfe
 length = pipe length without endings

Abschlussknöpfe für Messingläuferstangen Ø 16 x 3 mm/ endings for 16 x 3 mm brass stair rod

Messing gedreht,
 poliert, lackiert
 16 mm brass, twisted execution,
 polished, painted



1. Knaufform knob shape		05801-4	23,40/Paar/pair
2. Kronenform crown shape		05802-1	32,62/Paar/pair
3. Zepterform scepter shape		05803-8	32,62/Paar/pair
4. Imperial imperial shape		05806-9	65,30/Paar/pair
5. Eichelform oak shape		05804-5	23,40/Paar/pair
6. Zylinderform cylinder shape		05805-2	20,44/Paar/pair

72 Läuferstange Ø 16 x 1 mm Edelstahl matt/ stair rod Ø 16 x 1 mm stainless steel matt

ohne Abschlussknöpfe
 without endings

Länge = Rohrlänge **ohne**
 Abschlussknöpfe
 length = pipe length without
 endings



0,75	38930-9	20,10
0,8	38940-8	21,38
0,9	38950-7	24,06
1,0	05015-5	26,76
1,1	38960-6	29,40
1,2	38970-5	32,14
1,3	38980-4	34,74

194 Läuferstange Ø 16 x 2 mm Edelstahl matt/ stair rod Ø 16 x 2 mm stainless steel matt

ohne Abschlussknöpfe
 without endings

Länge = Rohrlänge **ohne**
 Abschlussknöpfe
 length = pipe length without
 endings



1,0	05014-8	37,42
1,5	38990-3	56,12
2,0	39000-8	74,78

Abschlussknopf Zylinderform für Edelstahl-Läuferstangen 16 x 1 und 16 x 2 mm

endings cylinder shape for stainless steel stair rod 16 x 1 and 16 x 2 mm



vernickelt nickel plated	05016-2	21,28/Paar/pair
vernickelt matt nickel plated mat	39010-7	25,48/Paar/pair

10. LÄUFERSTANGEN/ 10. STAIR RODS

Zubehör für Läuferstange Ø 16 mm

accessories for stair rod Ø 16 mm

Material/material	Abpackung/ unit	Art./ref.	€
-------------------	--------------------	-----------	---

182 Kugelöse für Läuferstange Ø 16 mm, gedreht/ ball eyelet for stair rod Ø 16 mm, twisted

gedrehte Ausführung mit
Stockschraube M5 x 30 für
stabilere Befestigung
twisted execution with hanger
bolt M5 x 30 for stronger fixing



Messing , poliert, lackiert brass, polished, painted	1 Stück /pcs.	05826-7	8,30/St./pcs.
Messing mit Feststellschraube brass with locking screw	1 Stück /pcs.	05827-4	9,70/St./pcs.
vernickelt nickel plated	1 Stück /pcs.	05828-1	9,70/St./pcs.
vernickelt mit Feststellschraube nickel plated with locking screw	1 Stück /pcs.	05829-8	11,16/St./pcs.
vernickelt matt nickel plated mat	1 Stück /pcs.	39020-6	13,98/St./pcs.
vernickelt matt mit Feststellschraube nickel plated mat with locking screw	1 Stück /pcs.	39030-5	15,40/St./pcs.

Kugelöse Ø 16 mm, gegossen / ball eyelet Ø 16 mm casted

Stockschraube 4 x 20 mm
hanger bolt 4 x 20 mm

Messing , poliert, lackiert brass polished, painted	1 Stück /pcs.	05811-3	6,14/St./pcs.
vernickelt/ nickel plated	1 Stück /pcs.	05812-0	7,14/St./pcs.

Eindrehwerkzeug für Kugelösen 16mm, Messing/ tool for ball eyelets 16 mm, brass

zur Verwendung im Akkuschauber/ for use in electric drills

72256-4	69,28/St./pcs.
---------	----------------

183 Klappöse, große Ausführung Ø 16 mm, offen/ folding eyelets large Ø 16 mm, open

inkl. Schr. + Dübel
incl. screws + dowels



Messing glatt/ brass smooth	1 Paar/pair	05510-5	39,46/Paar/pair
Messing mit Dekor/ brass with decor	1 Paar/pair	05530-3	40,76/Paar/pair
vernickelt glatt/ nickel plated smooth	1 Paar/pair	05520-4	45,28/Paar/pair
vernickelt mit Dekor/ nickel plated with decor	1 Paar/pair	05540-2	46,52/Paar/pair
vernickelt matt glatt/ nickel plated smooth	1 Paar/pair	39040-4	55,06/Paar/pair
vernickelt matt mit Dekor/ nickel plated with decor	1 Paar/pair	39050-3	50,54/Paar/pair

434 Klappöse, große Ausführung Ø 16 mm, geschlossen/ folding eyelets large Ø 16 mm, closed

inkl. Schr. + Dübel
incl. screws + dowels



Messing glatt/ brass smooth	1 Paar/pair	39060-2	39,46/Paar/pair
Messing mit Dekor/ brass with decor	1 Paar/pair	39070-1	40,76/Paar/pair
vernickelt glatt/ nickel plated smooth	1 Paar/pair	39065-7	45,28/Paar/pair
vernickelt matt glatt/ nickel plated smooth	1 Paar/pair	39075-6	55,06/Paar/pair

10. LÄUFERSTANGEN/ 10. STAIR RODS

Achtung: Der Aufpreis für die Anfertigung von Sonderlängen beträgt generell 15% zuzügl. Verschnitt!

Note: There is a 15% surcharge for special length cuts plus waste!

Der Läuferstangendurchmesser ist nach Läuferart und Verlegetechnik zu wählen! Wir beraten Sie gern!

Stair rod diameter should be selected according to type of carpet and laying technology! We advise you gladly!

Läuferstange Ø 25 mm

stair rod Ø 25 mm

Material/material	L / l (m)	Art./ref.	€
-------------------	-----------	-----------	---

184 Läuferstange Ø 25 x 4 mm Messing/ stair rod Ø 25 x 4 mm brass

4 mm Wandstärke/ 4 mm walls



Messing, poliert, lackiert brass polished, painted	1,0	39250-7	132,70/m
---	-----	---------	----------

Die Fertigung erfolgt objektbezogen/ manufactured on customers order

187 Abschlussknopf Imperial 25 mm/ endings imperial 25 mm



Messing poliert, lackiert brass polished, painted	39266-8	65,30/Paar/pair
--	---------	-----------------

185 Profi-Kugelöse 25 mm, gedreht/ profi-ball eyelet 25 mm, twisted

gedrehte Ausführung mit
Stockschraube M6 x 50
für stabilere Befestigung
twisted version with
hanger bolt M6 x 50
for stronger fastening



Messing, poliert, lackiert brass polished, painted	39262-0	32,56/St./pcs.
---	---------	----------------

Messing mit Feststellschraube brass with locking screw	39264-4	37,26/St./pcs.
---	---------	----------------

186 Klappöse Ø 25 mm, große Ausführung/ folding eyelets large Ø 25 mm

inkl. Schrauben+Dübel
incl. screws+dowels



Messing poliert, lackiert, offen, mit Dekor brass polished, painted, open, with decor	39260-6	56,86/Paar/pair
--	---------	-----------------

für Läuferbreiten bis 2,9 m ohne Mittelöse
im hochwertigen Objektbereich

for carpets with a width of 2,9 m without middle fixings in grand buildings

Staatstheater
Warschau/
state theatre Warsaw



11. REPARATURWINKEL FÜR TREPPEN & PVC-PROFILE

11. REPAIR ANGLES FOR STAIRS + PVC-FILES

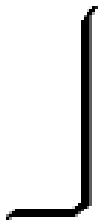

11. REPARATURWINKEL & PVC-PROFILE/ 11. REPAIR ANGLES + PVC-PROFILES

Schrauben + Dübel
siehe Abschnitt 12!
screws + dowels, see section 12!

Reparaturwinkel Edelstahl für Treppensanierung					
repair angle steel stainless steel for staircase renovation					
Material/material	Art./ref.	L / l (m)	Stk./VE / pcs/unit	€	

336 EDELSTAHL-Reparaturwinkel **B20** für Betontreppen

stainless steel repair angle
B20 for concrete stairs

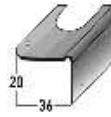

20 mm Nase 20 mm nose	ohne Befestigungszubehör without fixing accessories	00973-3	1,0	25	20,16
		00982-5	1,25		24,98
		00975-7	2,0		37,80

Extra Befestigungszubehör siehe
Abschnitt 12! / Extra fixing
accessories, see section 12!

Reparaturwinkel Stahl verzinkt für Treppensanierung					
repair angle steel galvanized for staircase renovation					
Material/material	Art./ref.	L / l (m)	Stk./VE / pcs/unit	€	

243 Reparaturwinkel **H15** für Holztreppen

repair angle H15
for wooden stairs



15 mm Nase 15 mm nose	inkl. Ringnägel incl. ruffled nails	00942-9	1,0	25	6,72
		00943-6	2,0		13,52
	ohne Befestigungszubehör without fixing accessories	00950-4	1,0	25	6,38
		00951-1	2,0		12,82

119 Reparaturwinkel **H20** für Holztreppen

repair angle H20
for wooden stairs



20 mm Nase 20 mm nose	inkl. Ringnägel incl. ruffled nails	00910-8	1,0	25	6,72
		00983-0	1,25		8,82
		00915-3	2,0		13,52
	ohne Befestigungszubehör without fixing accessories	00955-9	1,0	25	6,38
		00984-9	1,25		8,30
		00957-3	2,0		12,82

242 Reparaturwinkel **H38** für Holztreppen

repair angle H38
for wooden stairs



38 mm Nase 38 mm nose	inkl. Ringnägel incl. ruffled nails	00920-7	1,0	25	8,58
		00925-2	2,0		17,26
	ohne Befestigungszubehör without fixing accessories	00960-3	1,0	25	7,80
		00961-0	2,0		15,48

244 Reparaturwinkel **B15** für Betontreppen

repair angle B15
for concrete stairs

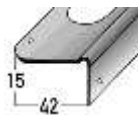

15 mm Nase 15 mm nose	inkl. Schrauben + Dübel incl. screws + dowels	00945-0	1,0	25	9,04
		00946-7	2,0		17,72
	ohne Befestigungszubehör without fixing accessories	00965-8	1,0	25	8,02
		00966-5	2,0		16,12

120 Reparaturwinkel **B20** für Betontreppen

repair angle B20
for concrete stairs

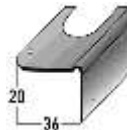

20 mm Nase 20 mm nose	inkl. Schrauben + Dübel incl. screws + dowels	00930-6	1,0	25	9,04
		00985-8	1,25		11,74
		00935-1	2,0		17,72
	ohne Befestigungszubehör without fixing accessories	00970-2	1,0	25	8,02
		00986-7	1,25		10,48
		00972-6	2,0		16,12

432 RUND-Reparaturwinkel **B25 x 40, R 7,5** für DEBOLON-TK 3

round repair angle
B25 x 40 R 7,5
for Debolon-TK 3



25 mm Nase 25 mm nose	inkl. Schrauben + Dübel incl. screws + dowels	00979-7	1,0	25	14,50
		00987-6	1,25		19,84
		00981-2	2,0		28,76
	ohne Befestigungszubehör without fixing accessories	00976-0	1,0	25	13,56
		00988-5	1,25		17,60
		00978-8	2,0		27,16

11. REPARATURWINKEL & PVC-PROFILE / 11. REPAIR ANGLES + PVC-PROFILES

PVC-Profile					
PVC profiles					
Material/material	Stk./VE / pcs/unit	L / l (m)	Farbe/ colour	Art./ref.	€/Stk./pcs.

356 PVC-Einfassleiste, einseitig

PVC insert profile, single-sided

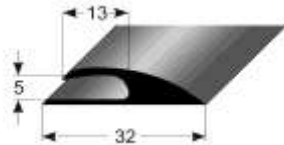

einseitig, ohne Kleber, weich PVC, für Beläge bis 5 mm single-sided, without adhesive, soft PVC, for floorings up to 5 mm	20	2,7 m	grau grey	52848-7	11,54
			schwarz black	52850-0	
			braun brown	52852-4	
			beige beige	52854-8	

357 PVC-Einfassleiste, doppelseitig

PVC insert profile, double-sided

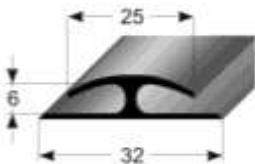

doppelseitig, ohne Kleber, weich PVC, für Beläge bis 6 mm double-sided, without adhesive, soft PVC, for floorings up to 6 mm	20	2,7 m	grau grey	52856-2	9,84
			schwarz black	52858-6	
			braun brown	52860-9	
			beige beige	52862-3	

246 PVC-Winkel für Stufenmatten, selbstklebend / PVC angle for stair mats, self-adhesive



23,5 x 53 mm, Oberfläche geriffelt, 40 mm Kleberbreite 23,5 x 53 mm, ribbed surface, 40 mm adhesive width	10	0,63 m	unbestimmt, Recycling-material indefinite, recycled material	52101-3	2,78
		2,7 m		52102-0	11,90

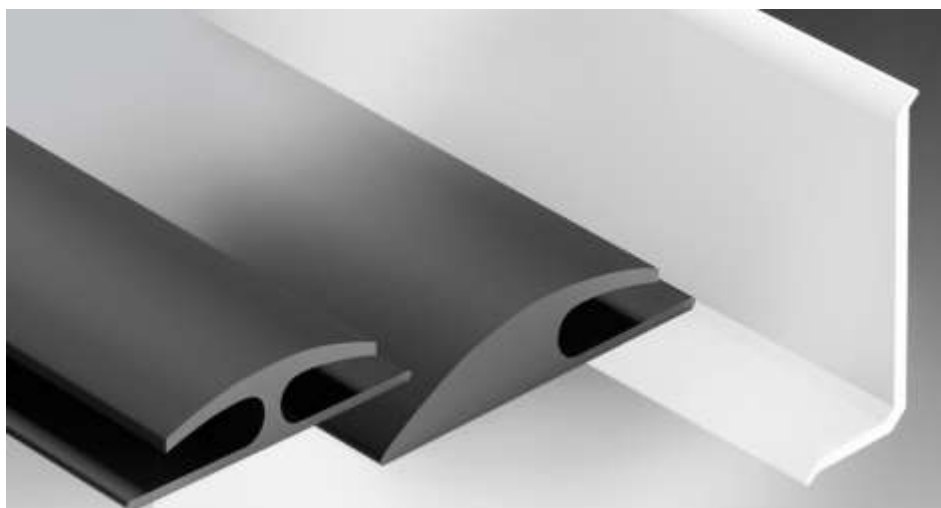

11. REPARATURWINKEL & PVC-PROFILE/ 11. REPAIR ANGLES + PVC-FILES

PVC-Profile					
PVC profiles					
Material/material	Stk./VE / pcs/unit	L / l (m)	Farbe/ colour	Art./ref.	€

51 PVC-Knickwinkel 20 x 20 mm

PVC bending angle

20 x 20 mm

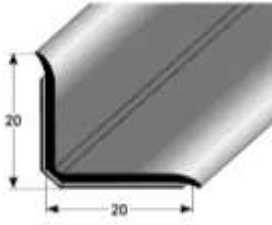

selbstklebend weich PVC auf Rolle self-adhesive soft PVC rolled	4	Rolle/ roll à 25 m	grau* / grey	57301-2	1,44/m
			braun* / brown	57303-6	35,92/Ro.
			beige* / beige	57304-3	
			Eiche hell* oak light	57305-0	1,50/m 37,74/Ro.

***Auslaufartikel** discontinued item

57 PVC-Sockelleiste 15 x 50 mm

PVC skirting 15 x 50 mm

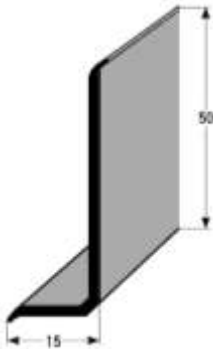

ohne Kleber weich PVC auf Rolle without adhesive soft PVC rolled	2	Rolle/ roll à 50 m	grau/ grey	58381-3	1,52/m 76,22/Ro.
			braun/ brown	58383-7	
			beige/ beige	58384-4	
			weiß/ white	58388-2	
			Eiche hell oak light	58385-1	
			Esche grau ash-tree grey	58387-5	
			Buche/ beech	58389-9	
			Ahorn/ maple	58420-9	

Verlegehinweis:

Behandeln Sie raue und saugende Untergründe mit Grundierung nach Herstellervorschrift vor.

Fettige Stellen müssen entfettet bzw. isoliert werden.

Installation tip:

Treat rough and absorbent surfaces with primer. Follow the manufacturers directions.

Greasy surfaces need to be degreased before installation!

433 PVC-Hohlkehprofil 25 x 25 mm als Stützerunterlage für Bodenbelagssockel

PVC hollow profile
25 x 25 mm
as floor to wall support

weich-PVC soft PVC	1	Rolle/ roll à 25 m	schwarz black	59502-1	3,50/m 87,34/Ro.
-----------------------	---	-----------------------	------------------	---------	---------------------



für einen optimalen Übergang der Bodenbeläge vom Boden zur Wand
 for best edge linking carpets from floor to wall

11. REPARATURWINKEL & PVC-PROFILE/ 11. REPAIR ANGLES + PVC-PROFILES

PVC-Treppenkanten					
PVC stair nosings					
Material/material	L / l (m)	Stk./VE / pcs/unit	Farbe/ colour	Art./ref.	€

361 PVC-Treppenkante **30 x 45 x 3 mm**/ PVC stair nosing 30 x 45 x 3 mm

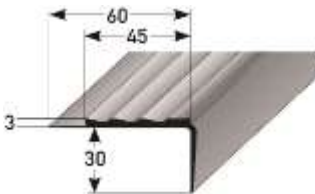

für Beläge bis 3 mm, weich PVC for floorings up to 3 mm, soft PVC	2,5	Kart./box à 30	grau/ grey	52800-5	8,26/m 20,66/St./pcs.
			schwarz/ black	52802-9	
			braun/ brown	52804-3	
			beige/ beige	52806-7	

362 PVC-Treppenkante **45 x 35 x 2 mm**/ PVC stair nosing 45 x 35 x 2 mm

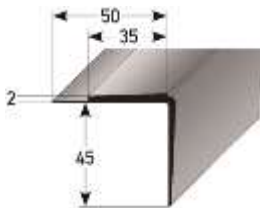

für Beläge bis 2 mm, weich PVC for floorings up to 2 mm, soft PVC	2,5	Kart./box à 30	grau/ grey	52808-1	8,70/m 21,76/St./pcs.
			schwarz/ black	52810-4	
			braun/ brown	52812-8	
			beige/ beige	52814-2	

363 PVC-Treppenkante **42 x 45 x 3 mm**/ PVC stair nosing 42 x 45 x 3 mm

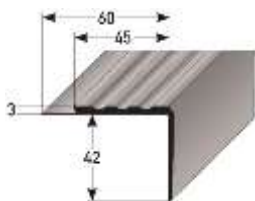

für Beläge bis 3 mm, weich PVC for floorings up to 3 mm, soft PVC	2,5	Kart./box à 25	grau/ grey	52816-6	8,08/m 20,22/St./pcs.
			schwarz/ black	52818-0	
			braun/ brown	52820-3	
			beige/ beige	52822-7	

364 PVC-Treppenkante **42 x 42 x 3 mm**/ PVC stair nosing 42 x 42 x 3 mm

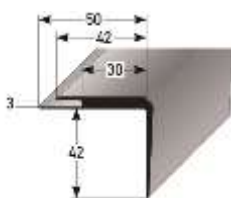

für Beläge bis 3 mm, weich PVC for floorings up to 3 mm, soft PVC	2,5	Kart./box à 20	grau/ grey	52824-1	8,92/m 22,30/St./pcs.
			schwarz/ black	52826-5	
			braun/ brown	52828-9	
			beige/ beige	52830-2	

366 PVC-Treppenkante **42 x 57 mm**/ PVC stair nosing 42 x 57 mm

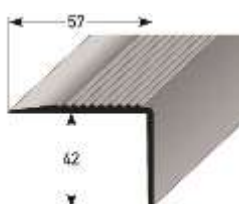

weich PVC soft PVC	2,5	Kart./box à 30	grau/ grey	52840-1	8,32/m 20,78/St./pcs.
			schwarz/ black	52842-5	
			braun/ brown	52844-9	
			beige/ beige	52846-3	

12. ZUBEHÖR

12. ACCESSORIES

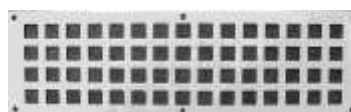
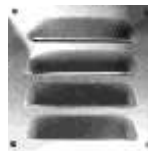

12. ZUBEHÖR / 12. ACCESSORIES

Bitte beachten Sie die Hinweise für Klebebänder im Abschnitt 13!

Please note the tips for adhesive tapes in section 13!

Spezialverlegeband / special tape

beidseitig klebender Acrylatkleber mit Gewebeträger, weitgehend weichmacherbeständig
 double-sided acrylat adhesive with fabric support, mostly plasticizer-resistant

Klebezubehör			
adhesive accessories			
Breite/width	Länge/ length (m) Rolle/roll à	Art./ref.	€/ Rolle/roll
50 mm	25 m	15024-4	26,00

Verlegeband super/ tape super

beidseitig klebend, extreme Klebkraft, z.B. für Sockelleisten / double-sided adhesive, extremely strong, e.g. for skirtings

35 mm	50 m	15026-8	53,42
-------	------	---------	-------

Verlegeband/ tape

beidseitig klebend, z.B. für Sockelleisten / double-sided adhesive, e.g. for skirtings

45 mm	50 m	15030-5	42,72
-------	------	---------	-------

Flachklebeband / flat tape



double-sided adhesive, for metall profiles, 1 adhesive strip 18 mm wide, 0,4 mm thick, based on synthetic rubber

22 mm	100 m	15040-4	136,40
-------	-------	---------	--------

beidseitig klebend für Metallprofile, 1 Klebstoffstreifen 18 mm breit, 0,4 mm dick, auf Basis Synthetikgummi

Flachschnurklebeband

flat corded tape



27 mm	250 m	15062-6	213,30
-------	-------	---------	--------

beidseitig klebend für Metallprofile, 2 Klebstoffstreifen, 6 mm breit, 0,8 mm dick

double-sided adhesive, for metall profiles, 2 adhesive strips, 6 mm wide, 0,8 mm thick

Rundschnurklebeband

corded tape



28 mm	100 m	15052-7	102,30
-------	-------	---------	--------

beidseitig klebend für Metallprofile, 2 Klebstoffstreifen, 2,5 mm Durchmesser

double-sided adhesive, for metall profiles, 2 adhesive strips, 2,5 mm diameter

Grundierung für Metallprofile/ primer for metall profiles

Für die Klebemontage empfehlen wir die Verwendung eines geeigneten Primers. Gerne beraten wir Sie dahingehend.



Art./ref.	€/Stk./pcs.
71956-4	auf Anfrage

We recommend using a suitable primer for adhesive mounting. We would be happy to advise you on this.

Montagekleber (Basis MSX-Polymer)

builders adhesive (based on MSX polymer)



Auswahl/ selection	Art./ref.	€/Stk./pcs.
Kartusche „FIX ALL FLEXI“ 470 g, weiß cartridge „FIX ALL FLEXI“ 470 g, white	22245-3	36,26

Kartusche „FIX ALL CRYSTAL“ 300 g, transparent cartridge „FIX ALL CRYSTAL“ 300 g, transparent	22257-6	36,26
---	---------	-------

Kartusche „FIX ALL TURBO“ 430 g, weiß cartridge „FIX ALL TURBO“ 430 g, white	22258-3	39,62
---	---------	-------

12. ZUBEHÖR / 12. ACCESSORIES

Spanplattenschrauben PZD 1/ TORX TX10

chipboard screws cross slot PZD 1/ TORX TX10

Abpackungen à 500 Stück, sowohl im Beutel als auch im Karton erhältlich. Bitte bei der Bestellung angeben.

Packs à 500 pcs. are available in bags and also in boxes.

Please specify when you place your order.

Größe/ dimension	Material/Farbe material/colour	Btl./VE bags/unit	Stückz./Btl. pcs./bag	Linsenkopf button head		Senkkopf countersunk head	
				Art./ref.	€/ Btl./bag	Art./ref.	€/ Btl./bag
3x20	Fe-Messing iron brass	30	50 SB	20031-4	2,64	20035-2	2,64
		30	10 SB	20032-1	0,76	20036-9	0,76
		30	100	20033-8	4,46	20037-6	4,46
		6	500	20034-5	21,34	20038-3	21,34
	Fe-Nickel iron nickel	30	50 SB	20041-3	2,64	20045-1	2,64
		30	10 SB	20042-0	0,76	20046-8	0,76
		30	100	20043-7	4,46	20047-5	4,46
		6	500	20044-4	21,34	20048-2	21,34
	Fe-bronze hell pulverbeschichtet bronze light powder coated	30	50 SB	16005-2	7,40	16025-0	7,40
		30	10 SB	16010-6	2,08	16030-4	2,08
		30	100	16015-1	13,52	16035-9	13,52
		6	500	16020-5	66,22	16040-3	66,22
	Fe-bronze dunkel iron bronze dark	30	50 SB	20051-2	2,64	20055-0	2,64
		30	10 SB	20052-9	0,76	20056-7	0,76
		30	100	20053-6	4,46	20057-4	4,46
		6	500	20054-3	21,34	20058-1	21,34
3x25	Fe-Messing iron brass	30	50 SB	20065-9	3,02	20061-1	3,02
		30	10 SB	20066-6	0,94	20062-8	0,94
		30	100	20067-3	5,36	20063-5	5,36
		6	500	20068-0	23,60	20064-2	23,60
	Fe-Nickel iron nickel	30	50 SB	20075-8	3,02	20071-0	3,02
		30	10 SB	20076-5	0,94	20072-7	0,94
		30	100	20077-2	5,36	20073-4	5,36
		6	500	20078-9	23,60	20074-1	23,60
	Fe-bronze hell pulverbeschichtet bronze light powder coated	30	50 SB	16045-8	7,98	16065-6	7,98
		30	10 SB	16050-2	2,16	16070-0	2,16
		30	100	16055-7	14,58	16075-5	14,58
		6	500	16060-1	71,82	16080-9	71,82
	Fe-bronze dunkel iron bronze dark	30	50 SB	20085-7	3,02	20081-9	3,02
		30	10 SB	20086-4	0,94	20082-6	0,94
		30	100	20087-1	5,36	20083-3	5,36
		6	500	20088-8	23,60	20084-0	23,60
3x30	Fe-Messing iron brass	30	50 SB	20091-8	3,72	20095-6	3,72
		30	10 SB	20092-5	1,00	20096-3	1,00
		30	100	20093-2	6,78	20097-0	6,78
		6	500	20094-9	32,54	20098-7	32,54
	Fe-Nickel iron nickel	30	50 SB	20101-4	3,72	20105-2	3,72
		30	10 SB	20102-1	1,00	20106-9	1,00
		30	100	20103-8	6,78	20107-6	6,78
		6	500	20104-5	32,54	20108-3	32,54
	Fe-bronze hell pulverbeschichtet bronze light powder coated	30	50 SB	16085-4	8,54	16105-9	8,54
		30	10 SB	16090-8	2,22	16110-3	2,22
		30	100	16095-3	15,76	16115-8	15,76
		6	500	16100-4	77,46	16120-2	77,46
	Fe-bronze dunkel iron bronze dark	30	50 SB	20111-3	3,72	20115-1	3,72
		30	10 SB	20112-0	1,00	20116-8	1,00
		30	100	20113-7	6,78	20117-5	6,78
		6	500	20114-4	32,54	20118-2	32,54

12. ZUBEHÖR / 12. ACCESSORIES

Spanlattenschrauben TORX TX10, Senkkopf					
chipboard screws cross slot PZD 1/ TORX TX10					
Abbildung illustration	Material/Farbe material/colour	Stückz./Btl. pcs./bag	Größe/ dimension	Art./ref.	€/ Btl./bag
	schwarz black	Btl./bag à 100	3x20	72260-1	8,18
			3x25	72262-5	8,98
			3x30	72264-9	11,02
	Fe-Nickel iron nickel	Btl./bag à 100	3,5x25	16000-7	6,22
			3,5x30	16001-4	7,90
			3,5x40	16002-1	10,54

Emaille-beschichtete Schrauben, PZD 1/ TORX TX10, Senkkopf					
enamel-coated screws PZD 1/ TORX TX10, countersunk head					
Abbildung illustration	Material/Farbe material/colour	Stückz./Btl. pcs./bag	Größe/ dimension	Art./ref.	€/ Btl./bag
	dunkelgrau metallic/ dark grey	Btl./bag à 100	3x25	40120-9	33,34
	silber metallic/ silver metallic			40270-1	

Profi-K-Spezialschraube, TX 10, Kopf 5,8 mm					
professional-K screws, TX 10, head 5,8 mm					
Abbildung illustration	Material/Farbe material/colour	Stückz./Btl. pcs./bag	Größe/ dimension	Art./ref.	€/ Btl./bag
	Fe-Nickel iron nickel	Btl./bag à 100	4x20	72516-9	16,32
			4x25	72518-3	18,32
			4x30	72520-6	20,34
			4x35	72522-0	23,32
			4x45	36640-9	23,60
	Fe-Messing iron brass		4x45	36630-0	23,60
	Fe-bronze hell iron bronze light		4x45	36645-4	32,58
	Fe-bronze dunkel iron bronze dark		4x45	36650-8	23,60

Edelstahlschrauben, Senkkopf, Kreuzschlitz, Beutel à 100 Stk.						
stainless steel screw, countersunk head, cross slot, bag à 100 pcs.						
Abbildung illustration	Größe/ dimension	Art./ref.	€/100 Stk./pcs.	Größe/ Dimension	Art./ref.	€/100 Stk./pcs.
	3x20	39330-6	11,36	3,5x16	39360-3	16,46
	3x25	39340-5	13,86	3,5x20	39365-8	18,06
	3x30	39350-4	14,80	3,5x25	39370-2	19,62
	4x40	39400-6	27,98	3,5x30	39380-1	21,64
	4x45	39410-5	30,96	3,5x40	39390-0	23,34
	4x50	39420-4	33,90			

Dübel					
dowels					
Bezeichnung/ Abbildung designation/ illustration	Maß/size (mm)	VE unit	Stk./Verpack. pcs./pack	Art./ref.	€/Btl./Kart. €/bag/box
Spreiz-Dübel expansion dowel 	5 mm	10	Btl./bag à 20 SB	20151-9	1,10
		10	Btl./bag à 100	20150-2	3,98
		5	Btl./bag à 500	20160-1	19,12
	6 mm	10	Btl./bag à 20 SB	20171-7	1,60
		10	Btl./bag à 100	20170-0	5,00
		5	Btl./bag à 500	20172-4	25,18

Quattro-Dübel					
quattro dowels Die Problemlöser! Problem solver!					
Bezeichnung/ Abbildung designation/ illustration	Maß/size (mm)	VE unit	Stk./Verpack. pcs./pack	Art./ref.	€/Btl./Kart. €/bag/box
	5 mm	10	Btl./bag à 100	20161-8	15,68
	6 mm	10	Btl./bag à 100	20165-6	20,22

12. ZUBEHÖR / 12. ACCESSORIES

Schrauben für Mini-APL- & SKD-System

screws for MINI-APL + SKD -system					
Material/Farbe material/colour	Btl./VE bags/unit	2,9 x 5,5 mm		2,9 x 9,0 mm	
		Art./ref.	€/100 Stk./pcs.	Art./ref.	€/100 Stk./pcs.
FE- verzinkt / iron galvanized	1	20986-7	12,86	20991-1	13,42
FE- vermessingt / iron brass plated		20987-4	12,86	20992-8	13,42
FE- bronze dunkel / iron bronze dark		20988-1	12,86	20993-5	13,42
FE- gelb verzinkt / iron yellow galvanized		20989-8	12,86	20994-2	13,42

Schrauben für APL- & SLP-System

screws for APL- and SLP-systems							
Material/Farbe material/colour	Btl./VE bags/unit	2,9 x 7 mm		2,9 x 11 mm		2,9 x 17 mm	
		Art./ref.	€/100 Stk./pcs.	Art./ref.	€/100 Stk./pcs.	Art./ref.	€/100 Stk./pcs.
FE- verzinkt iron galvanized	1	20971-3	12,86	70902-2	14,14	20981-2	14,44
FE- vermessingt iron brass plated		20972-0	12,86	70904-6	14,14	20982-9	14,44
FE- bronze dunkel iron bronze dark		20973-7	12,86	70906-0	14,14	20983-6	14,44
FE- gelb verzinkt iron yellow galvanized		20974-4	12,86	70908-4	14,14	20984-3	14,44

Material/Farbe material/colour	Btl./VE bags/unit	2,9 x 7 mm		2,9 x 13 mm		2,9 x 17 mm	
		Art./ref.	€/100 Stk./pcs.	Art./ref.	€/100 Stk./pcs.	Art./ref.	€/100 Stk./pcs.
Edelstahl stainless steel	1	20975-1	13,70	70910-7	14,70	20985-0	15,50

Extra Befestigungszubehör für Reparaturwinkel H15, H20, H38

extra fixing accessories for repair angle H15, H20, H38					
Beschreibung/ designation	Maß/size (mm)	Material/Farbe material/colour	Stück/Btl. pcs./bag	Art./ref.	€/ Btl./bag
Ringnägel riffled nails	2,2/ 2,4 x 27 mm	Fe-Nickel iron nickel plated	50	20181-6	1,46
			100	20180-9	2,66
			500	20182-3	12,52
		Fe-Messing iron brass plated	50	20201-1	1,46
			100	20200-4	2,66
			500	20202-8	12,52
		Fe-Bronze iron bronze plated	50	20211-0	1,46
			100	20210-3	2,66
			500	20212-7	12,52

Wegmarkierungsronden aus 2 mm **Edelstahl** matt

trail marker ronden out of 2 mm stainless steel matt			
Beschreibung/ designation	Durchmesser/ diameter (mm)	Art./ref.	€/ Stk./pcs.
Wegmarkierungs- ronden trail marker ronden	10	71400-2	2,46
	15	71402-6	3,70
	24	71404-0	4,94

12. ZUBEHÖR / 12. ACCESSORIES

Leistenstifte						
pins						
Bezeichnung/ Abb. designation/ illustration	Material/Farbe material/colour	Maß/size (mm)	Stk./Verpack. pcs./pack	VE unit	Art./ref.	€/Btl./Kart. €/bag/box

1,5 mm Leistenstifte Stahl, gehärtet

1,5 mm pins steel,
hardened



verzinkt galvanized	1,5x20	Karton à 1000 Stk. box à 1000 pcs.	5	20600-2	23,32
	1,5x25			20610-1	27,24
	1,5x30			20620-0	28,50
	1,5x35			20630-9	32,16
blank bare	1,5x20	Karton à 1000 Stk. box à 1000 pcs.	5	20640-8	17,80
	1,5x25			20650-7	18,56
	1,5x30			20660-6	19,24
	1,5x35			20670-5	21,18
vermessingt, lackiert brass plated, painted	1,5x25	Beutel à 100 Stk. bag à 100 pcs.	10	20680-4	4,82
	1,5x30			20685-9	5,70
	1,5x35			20690-3	7,10
	1,5x25	Karton à 1000 Stk. box à 1000 pcs.	5	20681-1	38,06
	1,5x30			20686-6	46,72
	1,5x35			20691-0	60,70

1,4 mm Leistenstifte Stahl, gehärtet

1,4 mm pins steel,
hardened

mit geschlagener
Spitze, für normale
Beanspruchung
with hammered tip,
for normal use



verzinkt galvanized	1,4x20	Kart./box à 1000	5	20300-1	13,52
		Btl./bag à 1000	5	20302-5	13,56
		Btl./bag à 100	10	20301-8	2,08
	1,4x25	Kart./box à 1000	5	20350-6	15,22
		Btl./bag à 1000	5	20352-0	15,42
		Btl./bag à 100	10	20351-3	2,12
	1,4x30	Kart./box à 1000	5	20400-8	16,80
		Btl./bag à 1000	5	20402-2	16,96
		Btl./bag à 100	10	20401-5	2,16
	1,4x35	Kart./box à 1000	5	20450-3	18,42
		Btl./bag à 1000	5	20452-7	18,56
		Btl./bag à 100	10	20451-0	2,18

"ELOXAL-FIX" Schleifreiniger, mittel, mit Körnung 120

zur Beseitigung von leichten
Oberflächenverunreinigungen eloxierter Profile
(nicht geeignet für eine durchbrochene Eloxalschicht)

Art./ref.	€/Stk./pcs.
22281-1	24,70

"ELOXAL-FIX" cleaning block, medium, with grain size 120
for removing facile surface contaminants at anodized profiles
(not suitable for a perforated anodized coating)



12. ZUBEHÖR / 12. ACCESSORIES

Türstopper				
door stopper				
Maß/size (mm)	Stk./Verpack. pcs./pack	VE unit	Art./ref.	€/Stk./pcs.

249 hochwertiger Türstopper für Wandmontage/ high quality door stopper for wall installation

Gesamttiefe 80 mm,
Schlüsselweite 24 mm
depth: 80 mm,
wrench opening: 24 mm



Messing brass	Karton à 10 Stk. box à 10 pcs.	1 Kart./box	20598-2	25,98
	SB Beutel à 1 Stk. bag à 1 pcs.	10 St./pcs	20599-9	26,94
vernickelt nickel plated	Karton à 10 Stk. box à 10 pcs.	1 Kart./box	20360-5	28,04
	SB Beutel à 1 Stk. bag à 1 pcs.	10 St./pcs	20361-2	29,04

79 hochwertiger Türstopper montagefertig/ high quality door stopper

Gesamthöhe 35 mm,
Durchmesser 28 mm
height 35 mm, diameter 28 mm



Messing brass	Karton à 10 Stk. box à 10 pcs.	1 Kart./box	20590-6	13,02
	SB Beutel à 1 Stk. bag à 1 pcs.	10 St./pcs	20592-0	14,22
vernickelt nickel plated	Karton à 10 Stk. box à 10 pcs.	1 Kart./box	20591-3	15,04
	SB Beutel à 1 Stk. bag à 1 pcs.	10 St./pcs	20593-7	16,26

248 Türstopper schwere Ausführung/ door stopper, heavy

Gesamthöhe 44 mm,
Durchmesser 38 mm
height 44 mm, diameter 38 mm





Messing brass	Karton à 10 Stk. box à 10 pcs.	1 Kart./box	20594-4	21,96
	SB Beutel à 1 Stk. bag à 1 pcs.	10 St./pcs	20596-8	23,00
vernickelt nickel plated	Karton à 10 Stk. box à 10 pcs.	1 Kart./box	20595-1	24,56
	SB Beutel à 1 Stk. bag à 1 pcs.	10 St./pcs	20597-5	25,58

andere Abmessungen
auf Anfrage
other dimensions on demand

Heizrohrrosetten aus 3 mm Edelstahl matt

heating pipe rosettes, 3 mm stainless steel matt

		AxBxC (mm)	Art./ref.	€/Stk./pcs.
278 Heizrohrrosette Komplettkreis heating pipe rosette full circle		50 x 12	14400-7	24,06
		50 x 15	14402-1	
		50 x 18	14404-5	
		50 x 22	14406-9	
279 Heizrohrrosette mit Wandteil heating pipe rosette with wall trim		50 x 12	14416-8	24,06
		50 x 15	14418-2	
		50 x 18	14420-5	
		50 x 22	14422-9	
280 Zwischenstück kombi- nierbar, für Doppelrohre insert pieces, for combination for double pipes		50 x 12 x 50	14408-3	33,00
		50 x 15 x 50	14410-6	
		50 x 18 x 50	14412-0	
		50 x 22 x 50	14414-4	

C = Abstand der Heizrohre/ distance between heating pipes

12. ZUBEHÖR / 12. ACCESSORIES

***Auslaufartikel**
discontinued item

Lüftungsbleche aus Aluminium

aluminum vents

Lüftungsblech/
vents **70 x 70 mm**

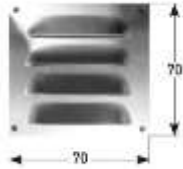

110 x 110 mm

150 x 150 mm

Farbe/ colour	VE/ unit	Art./ref.	€/St./ pcs.	SB-Verpackung/ self-service pack			€/Beutel/ bag
				VE/unit	St./Btl./ pcs./bag	Art./ref.	
silberfarbig eloxiert silver anodized	25	21013-9	1,52	10 Btl./ bag	à 2 St./pcs.	21014-6	4,18
goldfarbig eloxiert gold anodized		21000-9	2,82		à 4 St./pcs.	21015-3	7,24
weiß , PVC-beschichtet white, PVC-coated		21025-2	2,92		à 2 St./pcs.	21001-6	6,76
			à 4 St./pcs.		21002-3	12,40	
					à 2 St./pcs.	21026-9	6,96
					à 4 St./pcs.	21027-6	12,84
weiß , PVC-beschichtet white, PVC-coated	10	21305-5	4,72				
Kupfer antik , PVC-beschichtet * antique copper, PVC-coated		21300-0 *					
weiß , PVC-beschichtet white, PVC-coated	10	21315-4	8,24				
Kupfer antik , PVC-beschichtet * antique copper, PVC-coated		21310-9 *					

Lüftungsblech/
vents
Ø 70 mm



silberfarbig eloxiert silver anodized	25	21070-2	1,52	10 Btl./ bag	à 2 St./pcs.	21071-9	4,18
goldfarbig eloxiert gold anodized		21050-4	2,82		à 4 St./pcs.	21072-6	7,24
weiß , PVC-beschichtet white, PVC-coated		21056-6	2,92		à 2 St./pcs.	21051-1	6,76
Kupfer antik , PVC-beschichtet * antique copper, PVC-coated		21053-5 *	2,92		à 4 St./pcs.	21052-8	12,40
					à 2 St./pcs.	21057-3	6,96
					à 4 St./pcs.	21058-0	12,84
					à 2 St./pcs.	21054-2 *	6,96
					à 4 St./pcs.	21055-9 *	12,84

Lüftungsblech/
vents

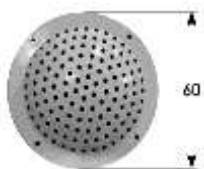

silberfarbig eloxiert silver anodized	25	21063-4	1,52	10 Btl./ bag	à 2 St./pcs.	21064-1	4,18
goldfarbig eloxiert gold anodized		21060-3	2,82		à 4 St./pcs.	21065-8	7,24
weiß , PVC-beschichtet white, PVC-coated		21040-5	2,92		à 2 St./pcs.	21061-0	6,76
Kupfer antik , PVC-beschichtet * antique copper, PVC-coated		21043-6 *	2,92		à 4 St./pcs.	21062-7	12,40
					à 2 St./pcs.	21041-2	6,96
					à 4 St./pcs.	21042-9	12,84
					à 2 St./pcs.	21044-3 *	6,96
					à 4 St./pcs.	21045-0 *	12,84

Lüftungsblech/
vents



silberfarbig eloxiert silver anodized	25	21073-3	1,42	10 Btl./ bag	à 2 St./pcs.	21074-0	3,96
goldfarbig eloxiert gold anodized		21030-6	2,72		à 4 St./pcs.	21075-7	6,80
weiß , PVC-beschichtet white, PVC-coated		21036-8	2,82		à 2 St./pcs.	21031-3	6,52
Kupfer antik , PVC-beschichtet * antique copper, PVC-coated		21033-7 *	2,82		à 4 St./pcs.	21032-0	11,94
					à 2 St./pcs.	21037-5	6,76
					à 4 St./pcs.	21038-2	12,40
					à 2 St./pcs.	21034-4 *	6,76
					à 4 St./pcs.	21035-1 *	12,40

Lüftungsblech **60 x 200 mm** / vents 60 x 200 mm

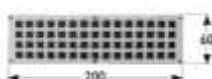

weiß , PVC-beschichtet white, PVC-coated	25	21190-7	7,38	10 Btl./ bag	à 2 St./pcs.	21201-0	15,86
--	----	---------	------	-----------------	--------------	---------	-------

Lüftungsblech **60 x 400 mm** / vents 60 x 400 mm



weiß , PVC-beschichtet white, PVC-coated	25	21240-9	14,44	10 Btl./ bag	à 2 St./pcs.	21241-6	30,00
--	----	---------	-------	-----------------	--------------	---------	-------

13. HINWEISE & AGB

13. HINTS + TERMS AND CONDITIONS



Verlegehinweise

1. Für Edelstahlprodukte: Unser Produkte werden, wenn nichts anderes angegeben ist, aus Edelstahl Werkstoff 1.4016 (poliert) und 1.4301 (V2A) für den chemisch nicht belasteten Innen- und Außenbereich hergestellt. Für chemisch belastete Bereiche können wir auf Anfrage die Produkte auch aus V4A Werkstoff 1.4571 fertigen.

2. Für die Klebemontage: Für die Klebemontage empfehlen wir die Verwendung eines geeigneten Primers. Gerne beraten wir Sie dahingehend.

3. Für Klebebänder: Der Untergrund muss fest, trocken, staub- und fettfrei sein!
Alle Klebebänder sind besonders umweltfreundlich, da lösungsmittelfrei!

Spezialverlegeband: als Untergrund eignen sich alle Flächen mit glatten, festen Oberflächen wie Gips, Keramik, Metall, Holz sowie festhaftende Tapete oder Farbanstrich

Verlegeband Super: speziell für rauhe, poröse Oberflächen wie Mauerwerk, Beton oder Putz (sofern nicht absandend)

4. Für selbstklebende Produkte:

Der Untergrund muss trocken, staub- und fettfrei, sowie gerade und tragfähig sein, um einen Klebekontakt von 100% zu erreichen. Ungeübte sollten vorab das Profil mit Trägerpapier mehrfach trocken auflegen. Notfalls Richtmarkierungen oder Anschläge verwenden, da die Profile in der Regel nur ein Mal verklebt werden können.

Bei Temperaturen über 80°C wird der Kleber stark elastisch bis flüssig.

Klebereste kann man mit Nitroverdünnung entfernen.

Trägerpapier nun abziehen und Aufkleben, dabei Klebebahn nicht mit Fingern berühren.

Verschiedene Faktoren können abstoßend wirken, wie z.B. Zementschleier, Teppichimprägnierung, Bodenbelagspflege, ausdünstende Beschichtungen, Restfeuchte.

Bitte Informationen beim jeweiligen Materiallieferanten einholen.

Bei Einsatz von Wölbprofilen im Fussboden + Objektbelastung kann es zum sogen. "**Walkeffekt**" kommen. Gibt das Profil beim Betreten in der Mitte nach unten nach (Kleber wird gewalkt), wird durch die Wölbung bedingte Steifheit des Profiles eine Hebelwirkung an den äusseren Enden nach oben erzeugt. Staub unterwandert den Kleber. Aufgrund dessen sollten die Profile **bauseits zusätzlich seitlich mit Montagekleber "Fix All" Art.-nr. 22245-3 fixiert** werden.

Der "Walkeffekt" betrifft auch Treppenkanten. Der Einsatz von Selbstklebeband wird hier nicht empfohlen. Der Kleber bleibt dauerelastisch (wie bei Dehnungsfugen), ist aber nicht für die Verklebung unter Decken geeignet. Senkrechte Wandverklebungen, sowie Sockelleisten müssen mit "Fix All" gesichert werden.

Achtung: Viele Wandoberflächen sind abweisend! Bitte Informationen beim jeweiligen Materiallieferanten einholen.

Der Einsatz von selbstklebenden Produkten bei Brandschutztüren unterliegt der Genehmigung durch den Türenhersteller (Gewährleistungsfrage).

Die Klebkraft kann beträchtlich erhöht werden, wenn Profil und Untergrund mit Heißluft erwärmt werden.

5. Für Gleitschutzeinlagen:

Einlage 12/ 23/ 39 / 50 mm breit, selbstklebend

Die Klebenut der Treppenkantenprofile trocken, staub- und fettfrei machen (Richtlinien f. Selbstklebeprodukte).

Die Einlagen entsprechend der Profillänge ausrollen und vorschneiden. Schutzfolie nach und nach abziehen und Einlage mit Andrückrolle fest anpressen. Der Kleber der Gleitschutzeinlage hat nach 24 Stunden seine volle Klebkraft erreicht. Die Gleitschutzeinlage beim Verlegen nicht dehnen.

Den Überstand nicht abschneiden, da sich das Band auf die vorgeschchnittene Länge wieder zusammenzieht. Reinigungsmittel, die den Kleber auflösen, sind nicht zu verwenden.

Einlage 27 mm breit, eben oder gerippt f. Kombi-Winkel

Die Einlagen entsprechend der Profillänge ausrollen und vorschneiden. Nun an das Profil anlegen und zentimeterweise eindrücken. Dabei nicht dehnen. Es ist mit einer Einlagenstreckung zu rechnen.

Die Einlage schrumpft nach einer gewissen Zeit in die vorgeschchnittene Länge zurück.

Bei sofortiger maßlicher Fertigstellung, besonders bei Gehrungsschnitten, ca. 50 mm

der **beiden Enden (rechts und links) mit Sekunden- oder Kontaktkleber (PVC-P/ Metall) fixieren.**

Gelegentliches Wechseln der Einlagen, je nach Verschleißgrad, sollte vorgesehen werden.

13. HINWEISE & AGB/ 13. ADVICE + TERMS AND CONDITIONS

Installation tips

- 1. For stainless steel:** Unless otherwise stated, our products are made of stainless steel material 1.4016 (polished) and 1.4301 (V2A) for interior and exterior areas that are not exposed to chemical loads. For chemically contaminated areas, we can also manufacture the products from V4A material 1.4571 on request.
- 2. For adhesive assembly:** We recommend using a suitable primer for adhesive mounting. We would be happy to advise you on this.
- 3. For adhesive tapes:** The surface should be strong, dry, free of dust and any grease!
- Special tape: suitable surfaces include smooth dry surfaces such as plaster, ceramic, metal, wood as well as glued wallpaper and painted walls
- Tape super: especially suitable for rough and porous surfaces such as bricks, and concrete

All adhesive tapes are environmentally friendly as they do not contain solvents!

4. For all self-adhesive products:

The surface should be dry, free of dust and grease as well as straight and stable in order to achieve 100 % adhesive contact. If you are not experienced, try profiles with the protective film. Use markings or other tools to help. Profiles usually can only be glued once. At temperatures above 80 °C adhesive becomes very elastic and liquid. Use nitro thinner to remove any adhesive leftover. Remove protective film and stick the profiles into position, without touching the adhesive surface. **Some factors can influence the strength of the adhesive bond: e.g. cement residue, carpet impregnation, vapours of coatings, humidity.** For more information please ask the supplier. The use of some profiles and heavy usage can lead to a **"bulging effect"**. If the profile is bent down slightly by stepping on it in the middle, the adhesive is "walked". The outside edges of the profile are lifted slightly and dust can get on the adhesive leaving the adhesive much less effective. **Fix the profiles laterally with builders adhesive to prevent this.** **"Fix All" Ref.-no. 22245-3.** The "bulging effect" may also occur with stair nosings, but the use of self-adhesive tape is not recommended here. Although the glue stays elastic, its use is not recommended under ceilings. Vertical installations need to be secured with "Fix All". Attention: Many wall surfaces do not bond! For more information please ask the supplier. For usage involving fire doors it is required to get a prior permission by the manufacturer. The adhesive strength can be substantially increased, if the profiles or surface is warmed with hot air.

5. For anti-slip inserts:

Insert 12/ 23/ 39 / 50 mm wide, self-adhesive

The adhesive seam of the profiles needs to be free of dust, dirt and grease. Roll out the insert according to the profile's length and cut bit by bit. Remove the protective film and push the insert tightly on the profile with a roll. The adhesive will have reached its full strength after 24h. Do neither stretch the insert during installation nor cut any surplus length of the insert. It will revert back to its original size after some time. Do not use any cleaning agents which dissolve the adhesive.

PVC insert 27 mm wide, smooth or ribbed for combination stair nosing

Roll out the inserts according to the length of the profiles and cut insert into the profile by pushing in 5 cm at a time, do not stretch the insert! Otherwise, it will revert back to its original length after some time. After installing the insert, but especially when miter cuts were used, fix the ends of the inserts (5cm) with **contact adhesive or superglue**. Please expect to change the inserts occasionally, depending on usage.

13. HINWEISE & AGB/ 13. ADVICE + TERMS AND CONDITIONS

Liefer- und Zahlungsbedingungen

1. Allgemeine Produktbeschreibungen, Zeichnungen, Muster, Abbildungen und Maße sind unverbindlich. Die Angaben sind daher nur nach schriftlicher Bestätigung verbindlich. Dies betrifft auch Auskünfte, Ratschläge und Empfehlungen unserer Mitarbeiter. Produktionsbedingte Farbabweichungen, Konstruktions- oder Formänderungen bleiben unter Vorbehalt, sofern keine erheblichen Änderungen des Kaufgegenstandes entstehen.
2. Allen Lieferungen werden die z.Z. der Lieferung geltenden Preise und Rabatte zugrunde gelegt. Der Käufer erkennt die vorliegenden Verkaufsbedingungen als verbindlich an.
3. Der Versand von Lagerware innerhalb Deutschlands erfolgt in der Regel innerhalb von 7 Werktagen (nach Vereinbarung auch kurzfristiger, Expresskosten werden vom Kunden getragen). Transportkosten und Lieferzeiten für Inselzustellungen sind separat zu erfragen.
Der Besteller hat bei Versendung der Ware an den von ihm benannten Bestimmungsort, im Rahmen seiner Mitwirkungspflicht, die erforderlichen Voraussetzungen für die Entgegennahme der Ware bei Anlieferung vor Ort zu schaffen. Das von uns beauftragte Liefer-/Zustellungsunternehmen ist nicht verpflichtet, am jeweiligen Bestimmungsort in unzumutbarer Weise nach dem Empfänger zu forschen. Kann die Ware nicht termingemäß zugestellt werden, weil der Empfänger am Bestimmungsort nicht festgestellt werden kann, gehen dadurch entstehende Zeitverzögerungen und Kosten für weitere Anfahrten zu Lasten des Bestellers.
Für Baustellenanlieferungen ist generell ein Telefonavis mit aktueller Telefonnummer auf Kundenkosten (+6 € netto) **Pflicht**, um Anlieferungsprobleme, Verzögerungen und Zusatzkosten zu vermeiden.
4. Aus versandtechnischen Gründen sind alle im Katalog mit 2,7 m ausgezeichneten Profile nur 2,69 m lang (Handelsbezeichnung bleibt weiterhin 2,7 m). Bei Bestellungen innerhalb Deutschlands ab 450 € netto erfolgt die Lieferung frei Haus, unter 450 € wird eine Kostenpauschale von 25 € berechnet, unter 75 € erheben wir zusätzlich einen Mindermengenaufschlag von 8 €. Diese Bedingungen gelten für Lieferungen bis 2,69 m. Lieferungen über 2,69 m erfolgen nur mit Spedition. Die Transportkostenhöhe ergibt sich aus Gewicht und Länge der Sendung.
5. Die Zahlungsfrist beträgt 10 Tage 3 % Skonto oder 30 Tage netto. Für Vorauskasse, Nachnahme und Bankeinzug gelten 4 % Skonto. Bis zur vollständigen Bezahlung der gelieferten Ware bleibt diese Eigentum des Lieferanten. Bei Zahlungsverzug sind wir berechtigt Verzugszinsen entsprechend den gesetzlichen Bestimmungen zu berechnen.
6. Gerichtsstand und Erfüllungsort für beide Vertragsteile ist Sitz des Lieferanten.
Schadenersatz- und Aufwendungsersatzansprüche des Käufers, gleich aus welchem Rechtsgrund, insbesondere wegen Verletzung von Pflichten aus einem Schuldverhältnis und aus unerlaubter Handlung, sind ausgeschlossen. Dies gilt nicht, soweit nach gesetzlichen Vorschriften oder Garantie zwingend gehaftet wird.
Bei Reklamationen von Transportschäden bitten wir Sie für Begutachtungen die Verpackung aufzuheben.
7. Nach §§ 26 und 34 Bundesdatenschutzgesetz sind wir verpflichtet, Sie davon in Kenntnis zu setzen, dass wir Daten Ihrer Firma bei uns speichern und verarbeiten. Selbstverständlich sind davon nur solche Angaben betroffen, die geschäftsnotwendig sind und direkt aus unserer Geschäftsbeziehung stammen.
8. Warenrücknahme erfolgt nur nach ausdrücklicher Genehmigung durch uns. Die Rücksendung ist in jedem Fall franko und in transportsicherer Verpackung vorzunehmen.
Bei Rücksendungen, die nicht auf unser Verschulden zurückzuführen sind, erheben wir eine Wiedereingliederungspauschale von 15%. Sonderanfertigungen werden nicht zurückgenommen.
9. Bei Sonderlängenzuschnitten in Einzellängenherstellung berechnen wir den anfallenden Materialverbrauch zuzüglich einem Arbeitsaufschlag von 15 %. Ab einer Serienfertigung von 30 Stück je Profil und Länge entfällt der Arbeitsaufschlag (Ausnahme: Läuferstangen).
10. Alle Preise sind zuzüglich Mehrwertsteuer.
11. Dieser Katalog, inkl. Liefer- & Zahlungsbedingungen, tritt ab 01.01.2025 in Kraft. Ältere Kataloge und die bisherigen Liefer- & Zahlungsbedingungen verlieren damit ihre Gültigkeit. Wir behalten uns vor kurzfristig unterjährig einen Teuerungsaufschlag einzuführen.

Umsatzsteueridentifikationsnummer: DE 141030233

AG Chemnitz HRB 2292
ILN 40 17589 00000 6



Unsere Bankverbindungen:

Deutsche Bank

IBAN: DE59 8707 0000 0747 1758 00
BIC: DEUTDE8CXXX

Commerzbank

IBAN: DE12 8708 0000 0660 3452 00
BIC: DRESDEFF870

13. HINWEISE & AGB/ 13. ADVICE + TERMS AND CONDITIONS

TERMS AND CONDITIONS

1. General product descriptions, drawings, pattern, illustrations and dimensions are not binding. The data are therefore binding only after written confirmation. This also applies to information, advice and recommendations of our employees. Production-related variations in colour, design or shape changes remain reserved, unless a significant change in the purchase item arises.
2. All deliveries are subject to the prices and discounts valid at the time of the delivery. The customer accepts the terms and conditions as legally binding.
3. Goods in stock are usually dispatched within 14 working days (or sooner after prior agreement, the customer may be subject to additional charges). The customer should make suitable arrangements to receive the goods at the specified address. Deliveries usually require a signature.
The delivery service may not search for the recipient at delivery time. If the goods cannot be delivered on time because the recipient cannot be determined at the destination, any resulting delays and costs for further delivery attempts will be borne by the customer.
For deliveries to construction sites, a telephone notification (+6 €) with a current telephone number is generally required at the customer's expense in order to avoid delivery problems, delays and additional costs.
4. For technical reasons, all the 2.7 m profiles in the catalog are only 2.69 m long (trade name remains 2.7 m). These terms apply to deliveries. Deliveries over 2,69 m are only possible with forwarding. The transport cost is calculated from the weight and length of the consignment.
5. Payment within 10 days permits a 3 % discount. Payment within 30 days of the net amount. Pre-payment, cash on delivery, or bankers draft are subject to a 4 % discount. Goods stay the property of the manufacturer until they are fully paid. For late payments we charge interest according to law.
6. Court of jurisdiction and place of fulfillment for both parties to a contract is the registered office of the supplier. In case of complaints about transport damages please retain the packaging for appraisals.
7. According to §§ 26 and 34 of the German Data Protection Act we are obliged to let you know that we store and process data of your business. We only store and process data which are necessary for conducting business and directly originate from our business relation.
8. Goods returns are only accepted after explicit prior permission by us. The return should be postage paid and the goods packed in suitable packaging. For returns which are not due to our mistakes we charge a 15% restocking fee. Custom made orders are not returnable.
9. Custom lengths are chargeable at cost of materials plus 15% extra labour costs. For custom orders of 30 pieces or more of a single profile and length, we waive the additional labour costs (exception: stair rods).
10. All prices are exclusive of VAT.
11. This catalog, including delivery and payment conditions, comes into force on 01.01.2025. Older catalogs and the previous terms of delivery and payment lose their validity. We reserve the right to introduce a surcharge at short notice during the year.

VAT registration number: DE 141030233

Trade register no: AG Chemnitz HRB 2292

ILN 40 17589 00000 6

Our bank details:

Deutsche Bank

IBAN: DE59 8707 0000 0747 1758 00

BIC: DEUTDE8CXXX

Commerzbank

IBAN: DE12 8708 0000 0660 3452 00

BIC: DRESDEFF870



EDELSTAHL-TREPPENKANTEN (Werkstoff 1.4301)

Treppenkanten mit profilierter Riffelung 1.5 mm stark. **Rutschhemmung R10**

10 x 30 x 1.5 mm



20 x 30 x 1.5 mm



30 x 30 x 1.5 mm



20 x 40 x 1.5 mm



40 x 40 x 1.5 mm

Treppenkanten mit gefräster Riffelung 3.0 mm stark

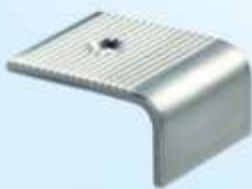

20 x 40 x 3 mm

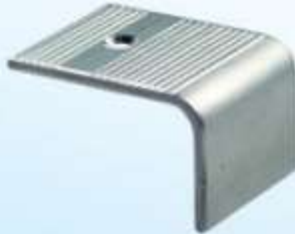

28 x 50 x 3 mm



30 x 30 x 3 mm

Einschubprofile mit Nase 1.5 mm stark

Höhe des Einschubes nach Bedarf



10 x 40 x 1.5 mm



10 x 40 x 1.5 mm

auch für runde Stufen möglich,
gebogen nach Schablone,
Radius oder Skizze

Einschubprofil mit Nase

Sicherheitsriffelung 3.0 mm



10 x 40 x 3 mm

EDELSTAHL-TREPPENKANTEN (Werkstoff 1.4301)

Treppenkanten mit Prägelochung 1.5 mm stark. **Rutschhemmung R12**

10 x 30 x 1.5 mm



10 x 30 x 1.5 mm (Anker)



20 x 40 x 1.5 mm



mit Anker: zum Einbetten in Beton oder zum nachträglichen Einkleben mit Spezialkleber (Diebstahlschutz)

ohne Anker: zum nachträglichen Verschrauben auf der Stufe

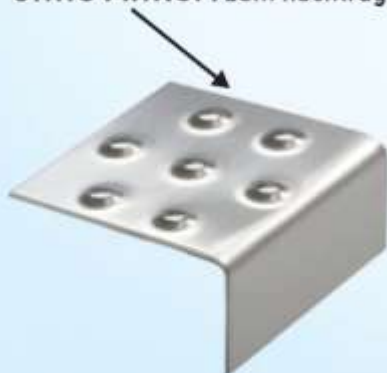

25 x 60 x 1.5 mm



25 x 80 x 1.5 mm



50 x 80 x 1.5 mm

Treppenkanten mit Prägelochung kommen bei Einrichtungen wie Bahnhöfen, Flughäfen, Skigebieten, Clubs, Diskotheken, Seniorenheimen, Krankenhäusern, Ämtern und Behörden zum Einsatz. Sie können aber auch hervorragend zur Treppensanierung eingesetzt werden.



Läuferstange 25 mm

Messing poliert,
lackiert



Läuferstange 10 mm

Messing poliert,
lackiert

Ø 10 x 0,8 mm
mit & ohne Stahlkern



Läuferstange 16 mm

Messing poliert,
lackiert



Läuferstange 10 mm

Edelstahl poliert

Ø 10 x 1,5 mm



Läuferstange 10 mm

Weiß beschichtet

Ø 10 x 1,5 mm



Läuferstange 16 mm

Edelstahl
matt geschliffen



Läuferstange 10 mm

Schwarz matt

Ø 10 x 1,5 mm



Dreikantläuferstange 16 mm

Messing poliert & lackiert,
Messing vernickelt

∇ 16 x 16 mm



Läuferstange 10 mm

Kupfer antik

Ø 10 x 1,5 mm



Läuferstange 13 mm

Messing poliert & lackiert,
Edelstahl poliert und matt geschliffen

Ø 13 x 1 mm
mit & ohne Stahlkern



Läuferstange 10 mm

Edelstahl
matt geschliffen

Ø 10 x 1,5 mm

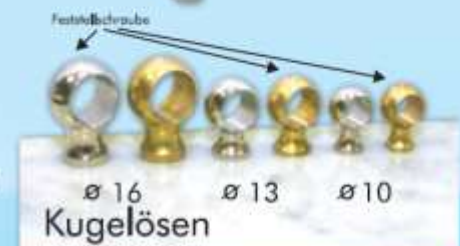



PROFILE ZUM BIEGEN

Artikel, die mit diesen Zeichen versehen sind, stanzen und biegen wir für Sie nach Angabe des Radius oder nach Schablone.



Treppenkanten



Einschubprofile



Einfäßschienen



Profile für Laminat / Parkett



T-Profile



Treppenkanten mit abriebfester und nachleuchtender Spezialemailierung

für bodennahe Leitsysteme nach BGR 216

Krankenhäuser, Seniorenheime, öffentl. Gebäude, Schiffe, Flughäfen, Tiefgaragen, Hotels usw.

20 x 40 mm

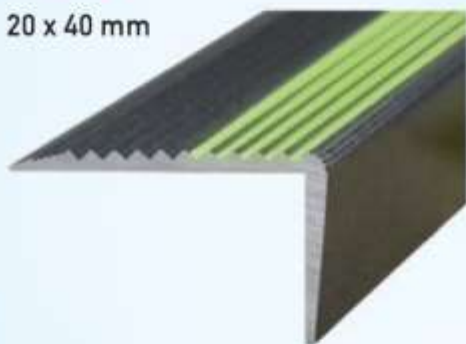

Leuchtzeit:

1 Stunde stark bei einer Mindestbeleuchtung von 100 Lux für ca. 5 min.

Alu-Profil mit lang nachleuchtendem Email, unbegrenzt oft wiederholbarer Nachleuchteffekt. Vollständige Beschichtung möglich - auch für andere Profile.

Eigenschaften:

abriebfest, desinfizierbar, keimabweisend, witterungsbeständig.

Das Material besteht aus ungiftigem und gefähndungsfreiem Erdalkalialuminat und ist als Aluschrott recyclingfähig.

Treppenkante mit LED-Beleuchtung

für Krankenhäuser, Seniorenheime, öffentliche Gebäude, Schiffe, Flughäfen, Tiefgaragen, Hotels, Gaststätten, Diskotheken, usw.

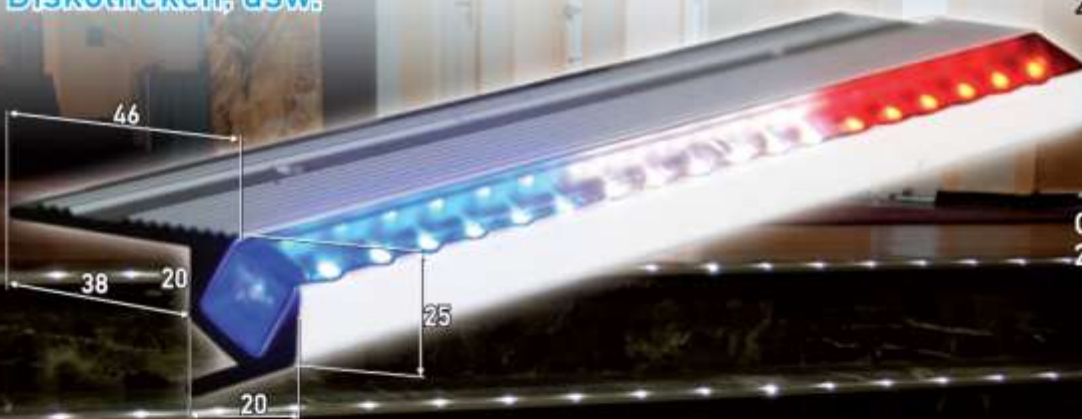

Schwarz
20 x 40

Grün
20 x 40

Rot
20 x 40

Blau
20 x 40

Gold
20 x 40

Silber
metallisch
20 x 40

Dunkelgrau
20 x 40

Profil-Farben: Silber, Gold, Bronze hell, Bronze dunkel, Edelstahlfarbig
LED-Farben: transparent, blau, rot, grün, gelb, lila - auf Wunsch mit Dimmer
Beleuchtungsleiste: 12V = 10 LED/lfm., alternativ 12 V = 30 LED/lfm.
Preise auf Anfrage



Unsere Musterkoffer Our sample cases



Musterkoffer Standard
sample case standard



Musterkoffer Läuferstangen
sample case stair rods



Individuelles aus Aue Individualized by Aue



Gravierte Eckschutzwinkel, Handyhalter, das Wappen Ihrer Kunden oder mattierte Hinweise auf Edelstahlplatten. Der Kreativität sind keine Grenzen gesetzt!

Engraved corner protection angles, cell phone holder, the coat of arms of your customers or matt indications on stainless steel plates. There are no limits for your creativity!

Unser Thekenaufsteller Our counter display

Our counter display





Bohren / drilling



Profilieren / profiling



Abkanten / folding

Nachleuchtende Treppenکanten
luminescent stair nosings

LED-beleuchtete Treppenکanten
LED-illuminated stair nosings

Edelstahlbeschichtete Treppenکanten
mit abriebfester Spezialemailierung
stainless steel coated stair nosings
with abrasion-resistant special enamelling

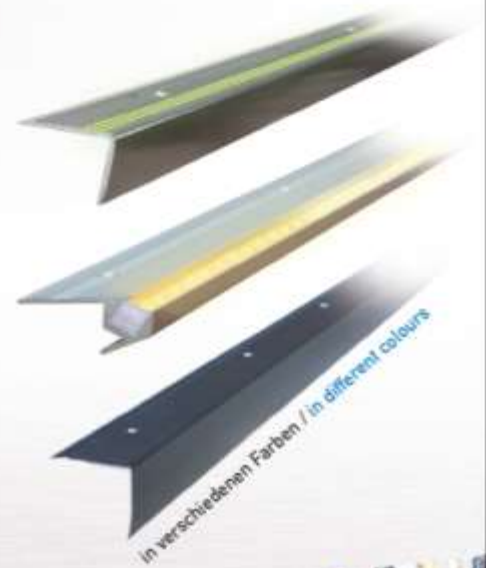

in verschiedenen Farben / in different colours



Jedes Profil in Folie eingeschumpft,
mit Schrauben, Dübel und EAN-Code versehen.
Every profile is shrink-wrapped in foil
with screws, dowels and European Article Number (EAN)



Management
System
ISO 9001:2015

www.aer.com
D 01028200







Auer Metallprofile GmbH
Muldenstraße 2
D-08280 Aue - Bad Schlema

Tel. +49 (0) 3771 / 28 68-0
Fax +49 (0) 3771 / 28 68-13
www.Auer-Metallprofile.de
info@Auer-Metallprofile.de



Unser Service für Sie:

Our service for you:

-  **Kurze Lieferzeiten**
(48 Stunden in Deutschland möglich)
short delivery times
(48 hours intrastate possible)
-  **Keine Mindestabnahmemenge**
no minimum purchase quantity
-  **Zuschnitte für Sonderlängen**
special cuts of lengths
-  **Abkantprofile nach Skizze**
folded profiles according to your sketch
-  **Biegen von Profilen**
bending of profiles
-  **Oberflächenbearbeitung**
(mattieren, polieren, brünieren, ...)
surface processing
(matt grinding, polishing, brass burnishing, ...)
-  **Flexible Farbgestaltung mit Eloxal-,
Emaille- und RAL-Farben**
flexible colour design with anodized, enamel
and RAL colours

